



Unlacquered Polished Brass (Finish ID : 7U)

JUPITER KNOB

	Item Code	Size (mm & Inches)	Material	Size (Inches)				Fig.
				A	B	C	D	
1	KNB.410.25.XX	25mm (0.98")	Brass	1.38	0.98	0.98	N/A	1
2	KNB.410.32.XX	32mm (1.26")	Brass	1.65	1.26	1.26	N/A	1
3	KNB.410.38.XX	38mm (1.5")	Brass	2.05	1.38	1.5	N/A	1

"XX" in item code denotes Finish ID.

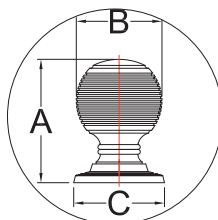
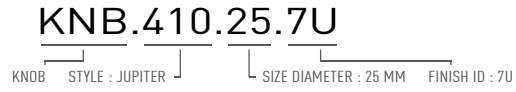

FIG. 1

This product is Supplied with M4x25mm screws.
This product is Supplied with M4x45mm break off screws.

How to Order



Jupiter Knob Finish Options

Base Material : Brass		Standard Finishes (2-3 Weeks Delivery)				
						
Bright Chrome (Finish ID:2)	Brush Nickel (Finish ID:3)	Aged Brass (Finish ID:4)	Oil Rubbed Bronze (Finish ID:5)	Unlacquered Polished Brass (Finish ID:7U)	Polished Nickel (Finish ID:8)	Satin Brass (Finish ID:13)
Base Material : Brass		Custom Finishes (3-4 Weeks Delivery)*				
						
Lacquered Polished Brass (Finish ID:7L)	Antique Copper (Finish ID:15)	Matte Black (Finish ID:19)	Rose Gold (Finish ID:33)	English Metallic Bronze (Finish ID:51)	Satin Copper (Finish ID:58)	Graphite (Finish ID:61)
						
Ombre (Finish ID:92)	Brush Chrome (Finish ID:95)					

- Custom finishes cannot be returned or refunded. We are unable to accept cancellations for custom finish order unless within 48 hours of the order being placed.
- We have uniform pricing for all non-hammered finishes listed above as long as base material and size is same.
- Contact us for customized finishes, refer pages F1, F2, F3 & F4 for finish glossary.
- Backplate options refer page KBP1-1 to KBP14-1.



Oil Rubbed Bronze (Finish ID : 5)

WESTWICK KNOB

	Item Code	Size (mm & Inches)	Material	Size (Inches)				Fig.
				A	B	C	D	
1	KNB.430.38.XX	38mm (1.5")	Brass	1.24	1.5	1.08	N/A	1
2	KNB.430.38.XX	38mm (1.5")	Cast Iron	1.24	1.5	1.08	N/A	1

"XX" in item code denotes Finish ID.

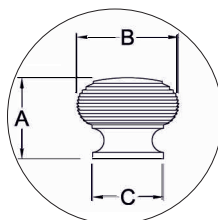

FIG. 1

This product is Supplied with M4x25mm screws.
This product is Supplied with M4x45mm break off screws.

How to Order

KNB.430.38.5

KNOB STYLE : WESTWICK SIZE DIAMETER : 38 MM FINISH ID : 5

Westwick Knob Finish Options

Base Material : Cast Iron		Custom Finishes (3-4 Weeks Delivery)*				
 <p>Pewter (Finish ID:1)</p>						
Base Material : Brass		Standard Finishes (2-3 Weeks Delivery)				
 <p>Bright Chrome (Finish ID:2)</p>  <p>Brush Nickel (Finish ID:3)</p>  <p>Aged Brass (Finish ID:4)</p>  <p>Oil Rubbed Bronze (Finish ID:5)</p>  <p>Untacquered Polished Brass (Finish ID:7U)</p>  <p>Polished Nickel (Finish ID:8)</p>  <p>Satin Brass (Finish ID:13)</p>						
Base Material : Brass		Custom Finishes (3-4 Weeks Delivery)*				
 <p>Lacquered Polished Brass (Finish ID:7L)</p>  <p>Antique Copper (Finish ID:15)</p>  <p>Ombre (Finish ID:92)</p>  <p>Brush Chrome (Finish ID:95)</p>						

- Custom finishes cannot be returned or refunded. We are unable to accept cancellations for custom finish order unless within 48 hours of the order being placed.
- We have uniform pricing for all non-hammered finishes listed above as long as base material and size is same.
- Contact us for customized finishes, refer pages F1, F2, F3 & F4 for finish glossary.
- Backplate options refer page KBP1-1 to KBP14-1.



Polished Nickel (Finish ID : 8)

RUGBY KNOB

	Item Code	Size (mm & Inches)	Material	Size (Inches)				Fig.
				A	B	C	D	
1	KNB.460.32.XX	32mm (1.26")	Brass	1.42	1.26	1.26	N/A	1
2	KNB.460.38.XX	38mm (1.5")	Brass	1.65	1.5	1.5	N/A	1

"XX" in item code denotes Finish ID.

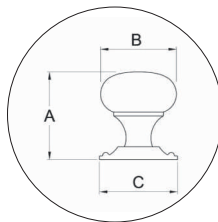

FIG. 1





















This product is Supplied with M4x30mm screws.
This product is Supplied with M4x45mm break off screws.

How to Order

















KNB.460.32.8

KNOB STYLE : RUGBY SIZE DIAMETER : 32 MM FINISH ID : 8

Rugby Knob Finish Options

Base Material : Brass			Standard Finishes (2-3 Weeks Delivery)			
						
Bright Chrome (Finish ID:2)	Brush Nickel (Finish ID:3)	Aged Brass (Finish ID:4)	Oil Rubbed Bronze (Finish ID:5)	Unlacquered Polished Brass (Finish ID:7U)	Polished Nickel (Finish ID:8)	Satin Brass (Finish ID:13)
Base Material : Brass			Custom Finishes (3-4 Weeks Delivery)*			
						
Lacquered Polished Brass (Finish ID:7L)	Hammered over Brush Nickel (Finish ID:12-3)	Hammered Over Oil Rubbed Bronze (Finish ID:12-5)	Hammered over Polished Nickel (Finish ID:12-8)	Hammered over Satin Brass (Finish ID:12-13)	Hammered over Rose Gold (Finish ID:12-33)	Antique Copper (Finish ID:15)
						
Matte Black (Finish ID:19)	Split Black and Polished Nickel with Polished Nickel Back Plate (Finish ID:48A)	Split Black and Polished Nickel with Black Back Plate (Finish ID:48B)	Split Black and Satin Brass with Satin Brass Back Plate (Finish ID:49A)	Split Black and Satin Brass with Black Back Plate (Finish ID:49B)	Split Satin Brass and White with Satin Brass Back Plate (Finish ID:50A)	Split Satin Brass and White with White Back Plate (Finish ID:50B)
						
English Metallic Bronze (Finish ID:51)	Split Polished Brass and Oil Rubbed Bronze with Polished Brass Back Plate (Finish ID:57A)	Split Polished Brass and Oil Rubbed Bronze with Oil Rubbed Bronze Back Plate (Finish ID:57B)	Satin Copper (Finish ID:58)	Split Black and Chrome with Chrome Back Plate (Finish ID:59A)	Split Black and Chrome with Black Back Plate (Finish ID:59B)	Split Satin Copper and Oil Rubbed Bronze with Satin Copper Back Plate (Finish ID:60A)





- Custom finishes cannot be returned or refunded. We are unable to accept cancellations for custom finish order unless within 48 hours of the order being placed.
- We have uniform pricing for all non-hammered finishes listed above as long as base material and size is same.
- Contact us for customized finishes, refer pages F1, F2, F3 & F4 for finish glossary.
- Backplate options refer page KBP1-1 to KBP14-1.

Base Material : Brass		Custom Finishes (3-4 Weeks Delivery)*				
						
<p>Split Satin Copper and Oil Rubbed Bronze with Oil Rubbed Bronze Back Plate (Finish ID:60B)</p>	<p>Graphite (Finish ID:61)</p>	<p>Split Aged Brass and English Metallic Bronze with Aged Brass Back Plate (Finish ID:75A)</p>	<p>Split Aged Brass and English Metallic Bronze with English Metallic Bronze Back Plate (Finish ID:75B)</p>	<p>Split Polished Nickel and Satin Brass with Satin Brass Back Plate (Finish ID:77A)</p>	<p>Split Polished Nickel and Satin Brass with Polished Nickel Back Plate (Finish ID:77B)</p>	<p>Split Brush Nickel and Satin Brass with Satin Brass Back Plate (Finish ID:78A)</p>
						
<p>Split Brush Nickel and Satin Brass with Brush Nickel Back Plate (Finish ID:78B)</p>	<p>Titanium (Finish ID:79)</p>	<p>Split Oil Rubbed Bronze And Satin Brass with Satin Brass Back Plate (Finish ID:80A)</p>	<p>Split Oil Rubbed Bronze And Satin Brass with Oil Rubbed Bronze Back Plate (Finish ID:80B)</p>	<p>Split Graphite and Satin Brass with Satin Brass Back Plate (Finish ID:90A)</p>	<p>Split Graphite and Satin Brass with Graphite Back Plate (Finish ID:90B)</p>	<p>Split Graphite and Brush Chrome with Graphite Back Plate (Finish ID:91A)</p>
						
<p>Split Graphite and Brush Chrome with Brush Chrome Back Plate (Finish ID:91B)</p>	<p>Ombre (Finish ID:92)</p>	<p>Brush Chrome (Finish ID:95)</p>				

- Custom finishes cannot be returned or refunded. We are unable to accept cancellations for custom finish order unless within 48 hours of the order being placed.
- We have uniform pricing for all non-hammered finishes listed above as long as base material and size is same.
- Contact us for customized finishes, refer pages F1, F2, F3 & F4 for finish glossary.
- Backplate options refer page KBP1-1 to KBP14-1.

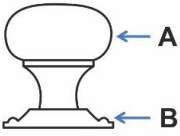
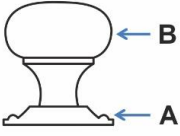
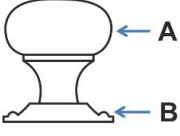

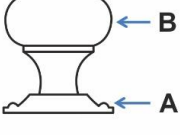
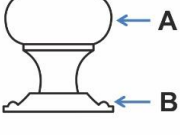
Rugby Knob Split Finish

KNB.460.XX.XX

FINISH CODE (XX)	FINISH NAME	LINE DRAWING	A	B
KNB.460.XX.48A	Split Black and Nickel with Polished Nickel Back Plate		Matte Black	Polished Nickel
KNB.460.XX.48B	Split Black and Nickel with Black Back Plate		Matte Black	Polished Nickel
KNB.460.XX.49A	Split Black and Satin Brass with Satin Brass Back Plate		Matte Black	Satin Brass
KNB.460.XX.49B	Split Black and Satin Brass with Black Back Plate		Matte Black	Satin Brass
KNB.460.XX.50A	Split Satin Brass and White with Satin Brass Back Plate		White Epoxy	Satin Brass
KNB.460.XX.50B	Split Satin Brass and White with White Back Plate		White Epoxy	Satin Brass
KNB.460.XX.57A	Split Lacquered Polished Brass and Oil Rubbed Bronze with Lacquered Polished Brass Back Plate		Oil Rubbed Bronze	Lacquered Polished Brass
KNB.460.XX.57B	Split Lacquered Polished Brass and Oil Rubbed Bronze with Oil Rubbed Bronze Back Plate		Oil Rubbed Bronze	Lacquered Polished Brass



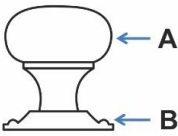
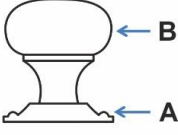
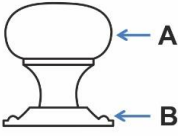
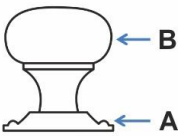
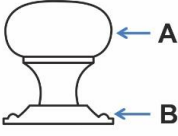
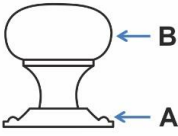

Rugby Knob Split Finish

KNB.460.XX.XX

FINISH CODE (XX)	FINISH NAME	LINE DRAWING	A	B
KNB.460.XX.59A	Split Black and chrome with chrome back plate		Matte Black	Bright Chrome
KNB.460.XX.59B	Split Black and chrome / Black back plate		Matte Black	Bright Chrome
KNB.460.XX.60A	Split Satin Copper and Oil Rubbed Bronze with Satin Copper Back Plate		Oil Rubbed Bronze	Satin Copper
KNB.460.XX.60B	Split Satin Copper and Oil Rubbed Bronze with Oil Rubbed Bronze Back Plate		Oil Rubbed Bronze	Satin Copper
KNB.460.XX.75A	Split Aged Brass and English Metallic Bronze with Aged Brass Back Plate		English Metallic Bronze	Aged Brass
KNB.460.XX.75B	Split Aged Brass and English Metallic Bronze with English Metallic Bronze Back Plate		English Metallic Bronze	Aged Brass
KNB.460.XX.77A	Split Polished Nickel and Satin Brass with Satin Brass Back Plate		Polished Nickel	Satin Brass
KNB.460.XX.77B	Split Polished Nickel and Satin Brass with Polished Nickel Back Plate		Polished Nickel	Satin Brass

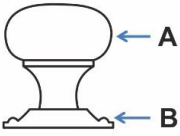
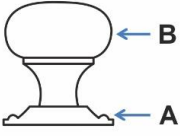
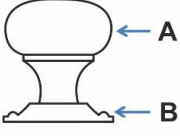
Rugby Knob Split Finish

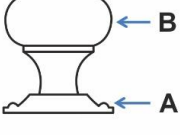
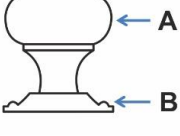
KNB.460.XX.XX

FINISH CODE (XX)	FINISH NAME	LINE DRAWING	A	B
KNB.460.XX.78A	Split Brush Nickel and Satin Brass with Satin Brass Back Plate		Brush Nickel	Satin Brass
KNB.460.XX.78B	Split Brush Nickel and Satin Brass with Brush Nickel Back Plate		Brush Nickel	Satin Brass
KNB.460.XX.80A	Split Oil Rubbed Bronze and Satin Brass with Satin Brass Back Plate		Oil Rubbed Bronze	Satin Brass
KNB.460.XX.80B	Split Oil Rubbed Bronze and Satin Brass with Oil Rubbed Bronze Back Plate		Oil Rubbed Bronze	Satin Brass
KNB.460.XX.90A	Split Graphite and Satin Brass with Satin Brass Back Plate		Graphite	Satin Brass
KNB.460.XX.90B	Split Graphite and Satin Brass with Graphite Back Plate		Graphite	Satin Brass
KNB.460.XX.91A	Split Graphite and Brush Chrome with Brush Chrome Back Plate		Graphite	Brush Chrome
KNB.460.XX.91B	Split Graphite and Brush Chrome with Graphite Back Plate		Graphite	Brush Chrome



Unlacquered Polished Brass (Finish ID : 7U)

IMPERIAL KNOB

Item Code	Size (mm & Inches)	Material	Size (Inches)				Fig.	
			A	B	C	D		
1	KNB.470.25.XX	25mm (0.98")	Brass	0.87	0.98	0.67	N/A	1
2	KNB.470.30.XX	30mm (1.18")	Brass	0.94	1.18	0.71	N/A	1
3	KNB.470.38.XX	38mm (1.5")	Brass	1.06	1.5	0.83	N/A	1
4	KNB.470.40.XX	40mm (1.57")	Brass	1.18	1.77	0.94	N/A	1
5	KNB.470.25.XX	25mm (0.98")	Hammered over Brass	0.87	0.98	0.67	N/A	1
6	KNB.470.30.XX	30mm (1.18")	Hammered over Brass	0.94	1.18	0.71	N/A	1
7	KNB.470.30.XX	38mm (1.5")	Hammered over Brass	1.06	1.5	0.83	N/A	1
8	KNB.470.40.XX	40mm (1.57")	Hammered over Brass	1.18	1.77	0.94	N/A	1
9	KNB.470.25.XX	25mm (0.98")	Pewter Effect\ Cast Iron	0.87	0.98	0.55	N/A	1
10	KNB.470.30.XX	30mm (1.18")	Pewter Effect\ Cast Iron	0.94	1.18	0.71	N/A	1

"XX" in item code denotes Finish ID.

This product is Supplied with M4x25mm screws.
This product is Supplied with M4x45mm break off screws.

	Item Code	Size (mm & Inches)	Material	Size (Inches)				Fig.
				A	B	C	D	
11	KNB.470.38.XX	38mm (1.5")	Pewter Effect\ Cast Iron	1.21	1.5	0.98	N/A	1
12	KNB.470.40.XX	40mm (1.57")	Pewter Effect\ Cast Iron	1.18	1.77	0.94	N/A	1
13	KNB.470.25.XX	25mm (0.98")	Bronze	0.87	0.98	0.67	N/A	1
14	KNB.470.30.XX	30mm (1.18")	Bronze	0.94	1.18	0.71	N/A	1
15	KNB.470.38.XX	38mm (1.5")	Bronze	1.17	1.5	0.83	N/A	1
16	KNB.470.40.XX	40mm (1.57")	Bronze	1.18	1.77	0.94	N/A	1

"XX" in item code denotes Finish ID.

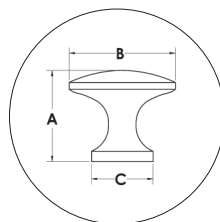

FIG. 1

This product is Supplied with M4x25mm screws.
This product is Supplied with M4x45mm break off screws.

How to Order

KNB.470.25.7U
KNOB STYLE : IMPERIAL SIZE DIAMETER : 25 MM FINISH ID : 7U

Imperial Knob Finish Options

Base Material : Cast Iron		Custom Finishes (3-4 Weeks Delivery)*				
 <p>Pewter (Finish ID:1)</p>						
Base Material : Brass		Standard Finishes (2-3 Weeks Delivery)				
 <p>Bright Chrome (Finish ID:2)</p>  <p>Brush Nickel (Finish ID:3)</p>  <p>Aged Brass (Finish ID:4)</p>  <p>Oil Rubbed Bronze (Finish ID:5)</p>  <p>Unlacquered Polished Brass (Finish ID:7U)</p>  <p>Polished Nickel (Finish ID:8)</p>  <p>Satin Brass (Finish ID:13)</p>						
Base Material : Brass		Custom Finishes (3-4 Weeks Delivery)*				
 <p>Lacquered Polished Brass (Finish ID:7L)</p>  <p>Hammered over Brush Nickel (Finish ID:12-3)</p>  <p>Hammered over Aged Brass (Finish ID:12-4)</p>  <p>Hammered Over Oil Rubbed Bronze (Finish ID:12-5)</p>  <p>Hammered over Polished Nickel (Finish ID:12-8)</p>  <p>Hammered over Satin Brass (Finish ID:12-13)</p>  <p>Hammered over Rose Gold (Finish ID:12-33)</p>  <p>Antique Copper (Finish ID:15)</p>  <p>Matte Black (Finish ID:19)</p>  <p>English Metallic Bronze (Finish ID:51)</p>  <p>Graphite (Finish ID:61)</p>  <p>Titanium (Finish ID:79)</p>  <p>Ombre (Finish ID:92)</p>  <p>Brush Chrome (Finish ID:95)</p>						
Base Material : Bronze		Custom Finishes (3-4 Weeks Delivery)*				
 <p>Silicon Bronze Light (Finish ID:53)</p>  <p>Silicon Bronze Dark (Finish ID:53D)</p>  <p>White Bronze (Finish ID:54)</p>						

- Custom finishes cannot be returned or refunded. We are unable to accept cancellations for custom finish order unless within 48 hours of the order being placed.
- We have uniform pricing for all non-hammered finishes listed above as long as base material and size is same.
- Contact us for customized finishes, refer pages F1, F2, F3 & F4 for finish glossary.
- Backplate options refer page KBP1-1 to KBP14-1.

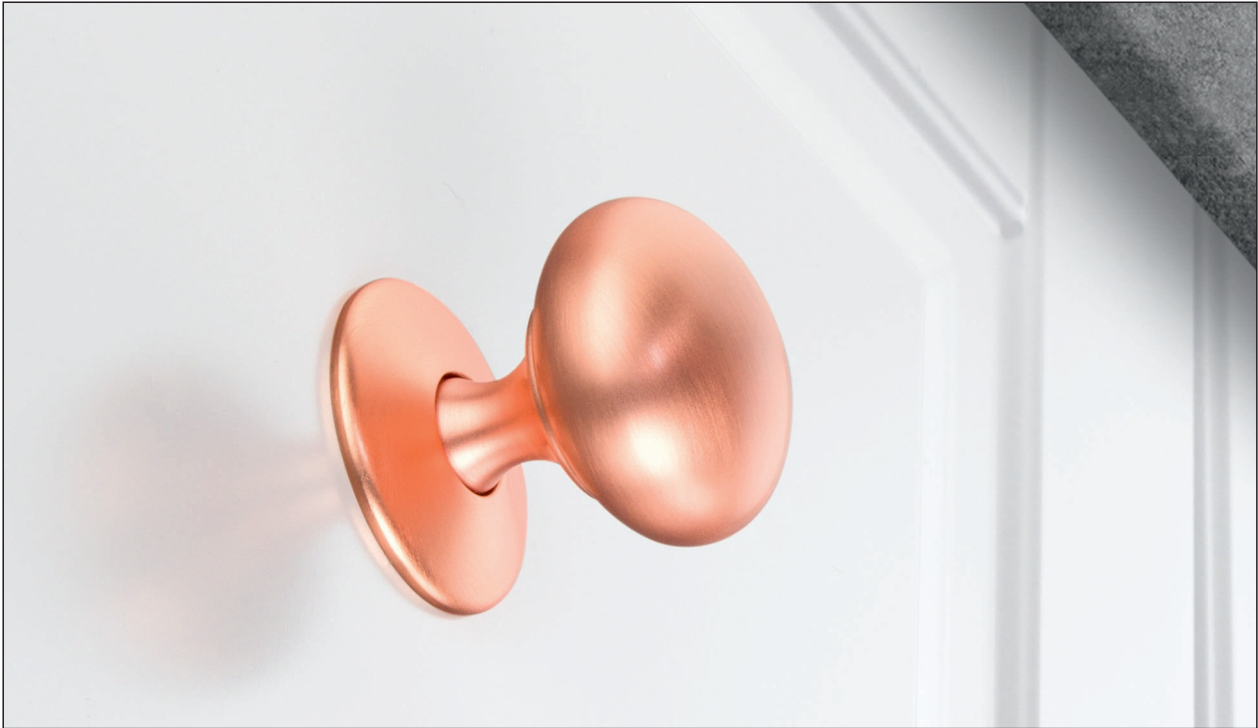

Satin Copper (Finish ID : 58)

MULBERRY KNOB WITH BACK PLATE

“The underlying principles of Shaker design continues to inspire designers of modern furniture – Mulberry a modern classic with perfect form and proportions”

Item Code	Size (mm & Inches)	Material	Size (Inches)				Fig.	
			A	B	C	D		
1	KNB.480.32.XX	32mm (1.26")	Brass	1.46	1.26	N/A	N/A	1
2	KNB.480.38.XX	38mm (1.5")	Brass	1.61	1.5	N/A	N/A	1
3	KNB.480.32.XX	32mm (1.26")	Hammered over Brass	1.46	1.26	N/A	N/A	1
4	KNB.480.38.XX	38mm (1.5")	Hammered over Brass	1.61	1.5	N/A	N/A	1

“XX” in item code denotes Finish ID.

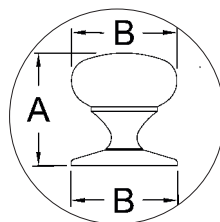

FIG. 1

This product is Supplied with M4x30mm screws.
This product is Supplied with M4x45mm break off screws.

How to Order

KNB.480.32.58

KNOB STYLE : MULBERRY WITH BACK PLATE SIZE DIAMETER : 32 MM FINISH ID : 58

Mulberry Knob With Back Plate Finish Options

Base Material : Brass				Standard Finishes (2-3 Weeks Delivery)		
						
Bright Chrome (Finish ID:2)	Brush Nickel (Finish ID:3)	Aged Brass (Finish ID:4)	Oil Rubbed Bronze (Finish ID:5)	Unlacquered Polished Brass (Finish ID:7U)	Polished Nickel (Finish ID:8)	Satin Brass (Finish ID:13)
Base Material : Brass				Custom Finishes (3-4 Weeks Delivery)*		
						
Lacquered Polished Brass (Finish ID:7L)	Hammered over Brush Nickel (Finish ID:12-3)	Hammered over Aged Brass (Finish ID:12-4)	Hammered Over Oil Rubbed Bronze (Finish ID:12-5)	Hammered over Polished Nickel (Finish ID:12-8)	Hammered over Satin Brass (Finish ID:12-13)	Hammered over Rose Gold (Finish ID:12-33)
						
Antique Copper (Finish ID:15)	Satin Copper (Finish ID:58)	Graphite (Finish ID:61)	Ombre (Finish ID:92)	Brush Chrome (Finish ID:95)		

- Custom finishes cannot be returned or refunded. We are unable to accept cancellations for custom finish order unless within 48 hours of the order being placed.
- We have uniform pricing for all non-hammered finishes listed above as long as base material and size is same.
- Contact us for customized finishes, refer pages F1, F2, F3 & F4 for finish glossary.
- Backplate options refer page KBP1-1 to KBP14-1.



Brush Nickel (Finish ID : 3)

CONWY ROUND KNOB

“Conway eschews the guiding principles of the Shaker movement – simplicity, utility and honesty of design.”

	Item Code	Size (mm & Inches)	Material	Size (Inches)				Fig.
				A	B	C	D	
1	RDKNB.510.30.XX	30mm (1.18")	Brass	0.79	1.18	0.47	N/A	1
2	RDKNB.510.35.XX	35mm (1.38")	Brass	0.83	1.38	0.47	N/A	1
3	RDKNB.510.30.XX	30mm (1.18")	Cast Iron	0.87	1.26	0.47	N/A	1
4	RDKNB.510.35.XX	35mm (1.38")	Cast Iron	0.87	1.46	0.47	N/A	1
5	RDKNB.510.30.XX	30mm (1.18")	Bronze	0.85	1.24	0.47	N/A	1
6	RDKNB.510.35.XX	35mm (1.38")	Bronze	0.85	1.46	0.47	N/A	1

“XX” in item code denotes Finish ID.

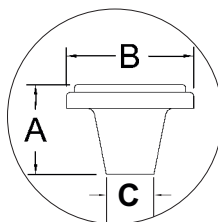

FIG. 1

This product is Supplied with M4x25mm screws.
This product is Supplied with M4x45mm break off screws.

How to Order

RDKNB.510.30.3

ROUND KNOB STYLE : CONWY SIZE DIAMETER : 30 MM FINISH ID : 3

Conwy Round Knob Finish Options

Base Material : Cast Iron		Custom Finishes (3-4 Weeks Delivery)*				
 <p>Pewter (Finish ID:1)</p>						
Base Material : Brass		Standard Finishes (2-3 Weeks Delivery)				
 <p>Bright Chrome (Finish ID:2)</p>  <p>Brush Nickel (Finish ID:3)</p>  <p>Aged Brass (Finish ID:4)</p>  <p>Oil Rubbed Bronze (Finish ID:5)</p>  <p>Untacquered Polished Brass (Finish ID:7U)</p>  <p>Polished Nickel (Finish ID:8)</p>  <p>Satin Brass (Finish ID:13)</p>						
Base Material : Brass		Custom Finishes (3-4 Weeks Delivery)*				
 <p>Lacquered Polished Brass (Finish ID:7L)</p>  <p>Matte Black (Finish ID:19)</p>  <p>Graphite (Finish ID:61)</p>  <p>Ombre (Finish ID:92)</p>  <p>Brush Chrome (Finish ID:95)</p>						
Base Material : Bronze		Custom Finishes (3-4 Weeks Delivery)*				
 <p>Silicon Bronze Light (Finish ID:53)</p>  <p>Silicon Bronze Dark (Finish ID:53D)</p>  <p>White Bronze (Finish ID:54)</p>						

- Custom finishes cannot be returned or refunded. We are unable to accept cancellations for custom finish order unless within 48 hours of the order being placed.
- We have uniform pricing for all non-hammered finishes listed above as long as base material and size is same.
- Contact us for customized finishes, refer pages F1, F2, F3 & F4 for finish glossary.
- Backplate options refer page KBP1-1 to KBP14-1.



Polished Nickel (Finish ID : 8)

CONWY SQUARE KNOB

“Conway eschews the guiding principles of the Shaker movement – simplicity, utility and honesty of design.”

	Item Code	Size (mm & Inches)	Material	Size (Inches)				Fig.
				A	B	C	D	
1	SQKNB.510.30.XX	30mm (1.18")	Brass	1.06	1.24	0.49	N/A	1
2	SQKNB.510.35.XX	35mm (1.38")	Brass	1.02	1.48	0.49	N/A	1
3	SQKNB.510.30.XX	30mm (1.18")	Cast Iron	0.98	1.3	0.55	N/A	1
4	SQKNB.510.35.XX	35mm (1.38")	Cast Iron	1.08	1.54	0.55	N/A	1
5	SQKNB.510.30.XX	30mm (1.18")	Bronze	1.08	1.24	0.49	N/A	1
6	SQKNB.510.35.XX	35mm (1.38")	Bronze	1.08	1.52	0.53	N/A	1

“XX” in item code denotes Finish ID.

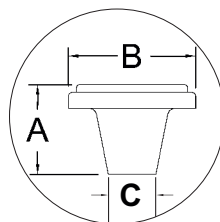
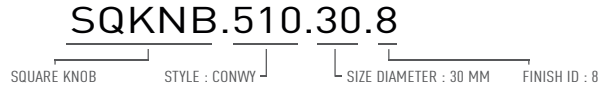

FIG. 1

This product is Supplied with M4x25mm screws.
This product is Supplied with M4x45mm break off screws.

How to Order



Conwy Square Knob Finish Options

Base Material : Cast Iron		Custom Finishes (3-4 Weeks Delivery)*				
 <p>Pewter (Finish ID:1)</p>						
Base Material : Brass		Standard Finishes (2-3 Weeks Delivery)				
       <p>Bright Chrome (Finish ID:2) Brush Nickel (Finish ID:3) Aged Brass (Finish ID:4) Oil Rubbed Bronze (Finish ID:5) Untacquered Polished Brass (Finish ID:7U) Polished Nickel (Finish ID:8) Satin Brass (Finish ID:13)</p>						
Base Material : Brass		Custom Finishes (3-4 Weeks Delivery)*				
     <p>Lacquered Polished Brass (Finish ID:7L) Matte Black (Finish ID:19) Graphite (Finish ID:61) Ombre (Finish ID:92) Brush Chrome (Finish ID:95)</p>						
Base Material : Bronze		Custom Finishes (3-4 Weeks Delivery)*				
   <p>Silicon Bronze Light (Finish ID:53) Silicon Bronze Dark (Finish ID:53D) White Bronze (Finish ID:54)</p>						

- Custom finishes cannot be returned or refunded. We are unable to accept cancellations for custom finish order unless within 48 hours of the order being placed.
- We have uniform pricing for all non-hammered finishes listed above as long as base material and size is same.
- Contact us for customized finishes, refer pages F1, F2, F3 & F4 for finish glossary.
- Backplate options refer page KBP1-1 to KBP14-1.



Polished Nickel (Finish ID : 8)

CONWY SQUARE KNOB WITH SQUARE BACK PLATE

“Conway eschews the guiding principles of the Shaker movement – simplicity, utility and honesty of design.”

	Item Code	Size (mm & Inches)	Material	Size (Inches)				Fig.
				A	B	C	D	
1	SQKNB.510.30.XX.SQB	30mm (1.18")	Brass	1.22	1.24	1.38	N/A	1
2	SQKNB.510.35.XX.SQB	35mm (1.38")	Brass	1.22	1.48	1.77	N/A	1
3	SQKNB.510.30.XX.SQB	30mm (1.18")	Cast Iron	1.22	1.24	1.38	N/A	1
4	SQKNB.510.35.XX.SQB	35mm (1.38")	Cast Iron	1.22	1.48	1.77	N/A	1
5	SQKNB.510.30.XX.SQB	30mm (1.18")	Bronze	1.22	1.24	1.38	N/A	1
6	SQKNB.510.35.XX.SQB	35mm (1.38")	Bronze	1.22	1.48	1.77	N/A	1

“XX” in item code denotes Finish ID.

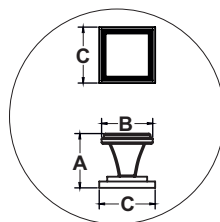

FIG. 1

This product is Supplied with M4x30mm screws.
This product is Supplied with M4x45mm break off screws.

How to Order

SQKNB.510.30.8.SQB



Conwy Square Knob With Square Back Plate Finish Options

Base Material : Cast Iron		Custom Finishes (3-4 Weeks Delivery)*				
 <p>Pewter (Finish ID:1)</p>						
Base Material : Brass		Standard Finishes (2-3 Weeks Delivery)				
 <p>Bright Chrome (Finish ID:2)</p>  <p>Brush Nickel (Finish ID:3)</p>  <p>Aged Brass (Finish ID:4)</p>  <p>Oil Rubbed Bronze (Finish ID:5)</p>  <p>Untacquered Polished Brass (Finish ID:7U)</p>  <p>Polished Nickel (Finish ID:8)</p>  <p>Satin Brass (Finish ID:13)</p>						
Base Material : Brass		Custom Finishes (3-4 Weeks Delivery)*				
 <p>Lacquered Polished Brass (Finish ID:7L)</p>  <p>Matte Black (Finish ID:19)</p>  <p>Graphite (Finish ID:61)</p>  <p>Ombre (Finish ID:92)</p>  <p>Brush Chrome (Finish ID:95)</p>						
Base Material : Bronze		Custom Finishes (3-4 Weeks Delivery)*				
 <p>Silicon Bronze Light (Finish ID:53)</p>  <p>Silicon Bronze Dark (Finish ID:53D)</p>  <p>White Bronze (Finish ID:54)</p>						

- Custom finishes cannot be returned or refunded. We are unable to accept cancellations for custom finish order unless within 48 hours of the order being placed.
- We have uniform pricing for all non-hammered finishes listed above as long as base material and size is same.
- Contact us for customized finishes, refer pages F1, F2, F3 & F4 for finish glossary.
- Backplate options refer page KBP1-1 to KBP14-1.



Satin Brass (Finish ID : 13)

BEAULIEU SQUARE KNOB

“Form and function complemented by a clean and defined stepped edge detail well reflect different colour accents.”

	Item Code	Size (mm & Inches)	Material	Size (Inches)				Fig.
				A	B	C	D	
1	SQKNB.520.30.XX	30mm (1.18")	Brass	1.18	1.22	0.43	N/A	1
2	SQKNB.520.35.XX	35mm (1.38")	Brass	1.18	1.38	0.43	N/A	1
3	SQKNB.520.30.XX	30mm (1.18")	Bronze	1.14	1.18	0.43	N/A	1
4	SQKNB.520.35.XX	35mm (1.38")	Bronze	1.18	1.46	0.43	N/A	1
5	SQKNB.520.30.XX	30mm (1.18")	Cast Iron	1.18	1.26	0.45	N/A	1
6	SQKNB.520.35.XX	35mm (1.38")	Cast Iron	1.18	1.5	0.45	N/A	1

“XX” in item code denotes Finish ID.

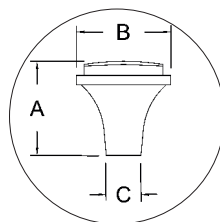

FIG. 1

This product is Supplied with M4x25mm screws.
This product is Supplied with M4x45mm break off screws.

How to Order

SQKNB.520.30.13
 SQUARE KNOB STYLE : BEAULIEU SIZE DIAMETER : 30 MM FINISH ID : 13

Beaulieu Square Knob Finish Options

Base Material : Cast Iron		Custom Finishes (3-4 Weeks Delivery)*				
 <p>Pewter (Finish ID:1)</p>						
Base Material : Brass		Standard Finishes (2-3 Weeks Delivery)				
 <p>Bright Chrome (Finish ID:2)</p>  <p>Brush Nickel (Finish ID:3)</p>  <p>Aged Brass (Finish ID:4)</p>  <p>Oil Rubbed Bronze (Finish ID:5)</p>  <p>Untacquered Polished Brass (Finish ID:7U)</p>  <p>Polished Nickel (Finish ID:8)</p>  <p>Satin Brass (Finish ID:13)</p>						
Base Material : Brass		Custom Finishes (3-4 Weeks Delivery)*				
 <p>Lacquered Polished Brass (Finish ID:7L)</p>  <p>Matte Black (Finish ID:19)</p>  <p>Graphite (Finish ID:61)</p>  <p>Ombre (Finish ID:92)</p>  <p>Brush Chrome (Finish ID:95)</p>						
Base Material : Bronze		Custom Finishes (3-4 Weeks Delivery)*				
 <p>Silicon Bronze Light (Finish ID:53)</p>  <p>Silicon Bronze Dark (Finish ID:53D)</p>  <p>White Bronze (Finish ID:54)</p>						

- Custom finishes cannot be returned or refunded. We are unable to accept cancellations for custom finish order unless within 48 hours of the order being placed.
- We have uniform pricing for all non-hammered finishes listed above as long as base material and size is same.
- Contact us for customized finishes, refer pages F1, F2, F3 & F4 for finish glossary.
- Backplate options refer page KBP1-1 to KBP14-1.



Polished Nickel (Finish ID:8)

BEAULIEU SQUARE KNOB WITH SQUARE BACK PLATE

“Form and function complemented by a clean and defined stepped edge detail well reflect different colour accents.”

	Item Code	Size (mm & Inches)	Material	Size (Inches)				Fig.
				A	B	C	D	
1	SQKNB.520.30.XX.SQB	30mm (1.18")	Brass	1.3	1.22	1.38	N/A	1
2	SQKNB.520.35.XX.SQB	35mm (1.38")	Brass	1.3	1.38	1.38	N/A	1
3	SQKNB.520.30.XX.SQB	30mm (1.18")	Cast Iron	1.3	1.26	1.38	N/A	1
4	SQKNB.520.35.XX.SQB	35mm (1.38")	Cast Iron	1.3	1.5	1.38	N/A	1
5	SQKNB.520.30.XX.SQB	30mm (1.18")	Bronze	1.3	1.18	1.38	N/A	1
6	SQKNB.520.35.XX.SQB	35mm (1.38")	Bronze	1.3	1.46	1.38	N/A	1

“XX” in item code denotes Finish ID.

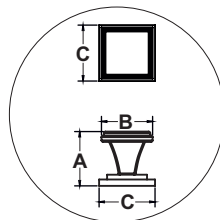

FIG. 1

This product is Supplied with M4x30mm screws.
This product is Supplied with M4x45mm break off screws.

How to Order

SQKNB.520.30.8.SQB



Beaulieu Square Knob With Square Back Plate Finish Options

Base Material : Cast Iron		Custom Finishes (3-4 Weeks Delivery)*				
 <p>Pewter (Finish ID:1)</p>						
Base Material : Brass		Standard Finishes (2-3 Weeks Delivery)				
 <p>Bright Chrome (Finish ID:2)</p>  <p>Brush Nickel (Finish ID:3)</p>  <p>Aged Brass (Finish ID:4)</p>  <p>Oil Rubbed Bronze (Finish ID:5)</p>  <p>Untacquered Polished Brass (Finish ID:7U)</p>  <p>Polished Nickel (Finish ID:8)</p>  <p>Satin Brass (Finish ID:13)</p>						
Base Material : Brass		Custom Finishes (3-4 Weeks Delivery)*				
 <p>Lacquered Polished Brass (Finish ID:7L)</p>  <p>Matte Black (Finish ID:19)</p>  <p>Graphite (Finish ID:61)</p>  <p>Ombre (Finish ID:92)</p>  <p>Brush Chrome (Finish ID:95)</p>						
Base Material : Bronze		Custom Finishes (3-4 Weeks Delivery)*				
 <p>Silicon Bronze Light (Finish ID:53)</p>  <p>Silicon Bronze Dark (Finish ID:53D)</p>  <p>White Bronze (Finish ID:54)</p>						

- Custom finishes cannot be returned or refunded. We are unable to accept cancellations for custom finish order unless within 48 hours of the order being placed.
- We have uniform pricing for all non-hammered finishes listed above as long as base material and size is same.
- Contact us for customized finishes, refer pages F1, F2, F3 & F4 for finish glossary.
- Backplate options refer page KBP1-1 to KBP14-1.

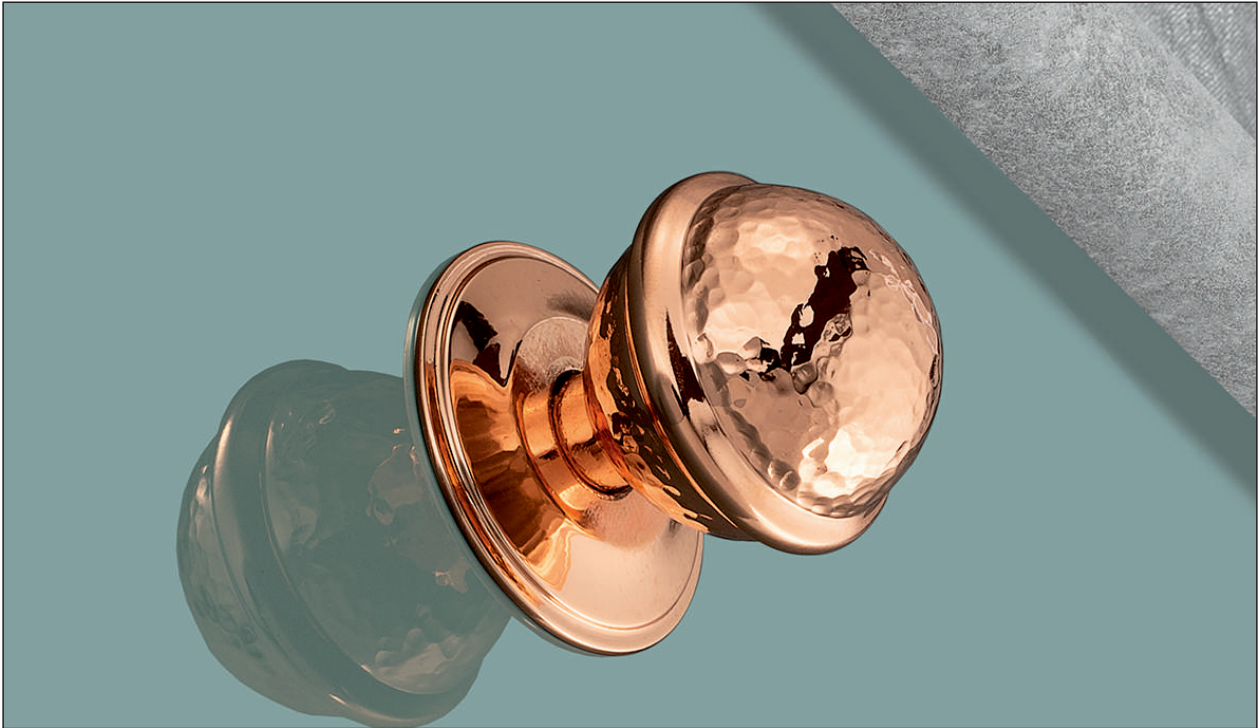

Hammered over Rose Gold (Finish ID : 12-33)

ROCHER KNOB WITH ROUND BACK PLATE

“Reflection of light from the rings increases Saturn's brightness, this could equally be describing the Rocher knob who's ring accentuates the light and contrast of the many finishes we can offer.”

	Item Code	Size (mm & Inches)	Material	Size (Inches)				Fig.
				A	B	C	D	
1	KNB.604.32.XX.RDB	32mm (1.26")	Brass	1.4	1.26	N/A	N/A	1
2	KNB.604.35.XX.RDB	35mm (1.38")	Brass	1.77	1.38	N/A	N/A	1
3	KNB.604.32.XX.RDB	32mm (1.26")	Hammered over Brass	1.4	1.26	N/A	N/A	1
4	KNB.604.35.XX.RDB	35mm (1.38")	Hammered over Brass	1.77	1.38	N/A	N/A	1

“XX” in item code denotes Finish ID.

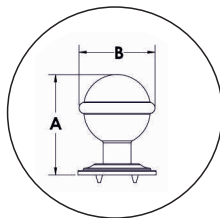

FIG. 1

This product is Supplied with M4x30mm screws.
This product is Supplied with M4x45mm break off screws.

How to Order

KNB.604.32.12-33.RDB



Rocher Knob With Round Back Plate Finish Options

Base Material : Brass				Standard Finishes (2-3 Weeks Delivery)		
						
Bright Chrome (Finish ID:2)	Brush Nickel (Finish ID:3)	Aged Brass (Finish ID:4)	Oil Rubbed Bronze (Finish ID:5)	Unlacquered Polished Brass (Finish ID:7U)	Polished Nickel (Finish ID:8)	Satin Brass (Finish ID:13)
Base Material : Brass				Custom Finishes (3-4 Weeks Delivery)*		
						
Lacquered Polished Brass (Finish ID:7L)	Hammered over Brush Nickel (Finish ID:12-3)	Hammered over Aged Brass (Finish ID:12-4)	Hammered Over Oil Rubbed Bronze (Finish ID:12-5)	Hammered over Polished Nickel (Finish ID:12-8)	Hammered over Satin Brass (Finish ID:12-13)	Hammered over Rose Gold (Finish ID:12-33)
						
Matte Black (Finish ID:19)	Split Black and Polished Nickel with Polished Nickel Back Plate (Finish ID:48A)	Split Black and Polished Nickel with Black Back Plate (Finish ID:48B)	Split Black and Satin Brass with Satin Brass Back Plate (Finish ID:49A)	Split Black and Satin Brass with Black Back Plate (Finish ID:49B)	Split Satin Brass and White with Satin Brass Back Plate (Finish ID:50A)	Split Satin Brass and White with White Back Plate (Finish ID:50B)
						
English Metallic Bronze (Finish ID:51)	Split Polished Brass and Oil Rubbed Bronze with Polished Brass Back Plate (Finish ID:57A)	Split Polished Brass and Oil Rubbed Bronze with Oil Rubbed Bronze Back Plate (Finish ID:57B)	Split Black and Chrome with Chrome Back Plate (Finish ID:59A)	Split Black and Chrome with Black Back Plate (Finish ID:59B)	Split Satin Copper and Oil Rubbed Bronze with Satin Copper Back Plate (Finish ID:60A)	Split Satin Copper and Oil Rubbed Bronze with Oil Rubbed Bronze Back Plate (Finish ID:60B)

- Custom finishes cannot be returned or refunded. We are unable to accept cancellations for custom finish order unless within 48 hours of the order being placed.
- We have uniform pricing for all non-hammered finishes listed above as long as base material and size is same.
- Contact us for customized finishes, refer pages F1, F2, F3 & F4 for finish glossary.
- Backplate options refer page KBP1-1 to KBP14-1.

Base Material : Brass		Custom Finishes (3-4 Weeks Delivery)*				
						
Graphite (Finish ID:61)	Split Aged Brass and English Metallic Bronze with Aged Brass Back Plate (Finish ID:75A)	Split Aged Brass and English Metallic Bronze with English Metallic Bronze Back Plate (Finish ID:75B)	Split Polished Nickel and Satin Brass with Satin Brass Back Plate (Finish ID:77A)	Split Polished Nickel and Satin Brass with Polished Nickel Back Plate (Finish ID:77B)	Split Brush Nickel and Satin Brass with Satin Brass Back Plate (Finish ID:78A)	Split Brush Nickel and Satin Brass with Brush Nickel Back Plate (Finish ID:78B)
						
Split Oil Rubbed Bronze And Satin Brass with Satin Brass Back Plate (Finish ID:80A)	Split Oil Rubbed Bronze And Satin Brass with Oil Rubbed Bronze Back Plate (Finish ID:80B)	Split Graphite and Satin Brass with Satin Brass Back Plate (Finish ID:90A)	Split Graphite and Satin Brass with Graphite Back Plate (Finish ID:90B)	Split Graphite and Brush Chrome with Graphite Back Plate (Finish ID:91A)	Split Graphite and Brush Chrome with Brush Chrome Back Plate (Finish ID:91B)	Ombre (Finish ID:92)
						
Brush Chrome (Finish ID:95)						

- Custom finishes cannot be returned or refunded. We are unable to accept cancellations for custom finish order unless within 48 hours of the order being placed.
- We have uniform pricing for all non-hammered finishes listed above as long as base material and size is same.
- Contact us for customized finishes, refer pages F1, F2, F3 & F4 for finish glossary.
- Backplate options refer page KBP1-1 to KBP14-1.

Rocher Knob With Round Back Plate Split Finish

KNB.604.XX.XX.RDB

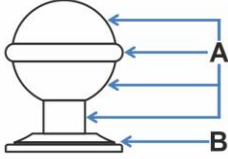
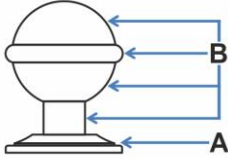
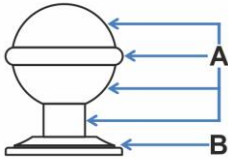
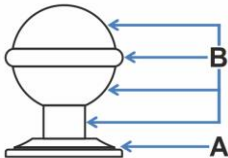
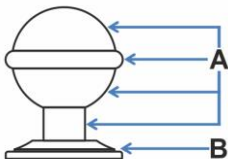
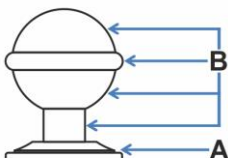
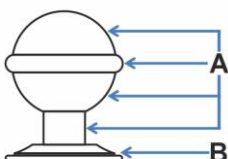
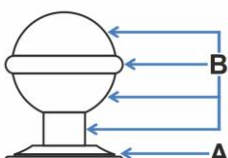
FINISH CODE (XX)	FINISH NAME	LINE DRAWING	A	B
KNB.604.XX.48A.RDB	Split Black and Nickel with Polished Nickel Back Plate		Matte Black	Polished Nickel
KNB.604.XX.48B.RDB	Split Black and Nickel with Black Back Plate		Matte Black	Polished Nickel
KNB.604.XX.48A.RDB	Split Black and Satin Brass with Satin Brass Back Plate		Matte Black	Satin Brass
KNB.604.XX.49B.RDB	Split Black and Satin Brass with Black Back Plate		Matte Black	Satin Brass
KNB.604.XX.50A.RDB	Split Satin Brass and White with Satin Brass Back Plate		White Epoxy	Satin Brass
KNB.604.XX.50B.RDB	Split Satin Brass and White with White Back Plate		White Epoxy	Satin Brass
KNB.604.XX.57A.RDB	Split Lacquered Polished Brass and Oil Rubbed Bronze with Lacquered Polished Brass Back Plate		Oil Rubbed Bronze	Lacquered Polished Brass
KNB.604.XX.57B.RDB	Split Lacquered Polished Brass and Oil Rubbed Bronze with Oil Rubbed Bronze Back Plate		Oil Rubbed Bronze	Lacquered Polished Brass

Rocher Knob With Round Back Plate Split Finish

KNB.604.XX.XX.RDB

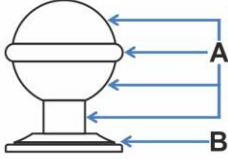
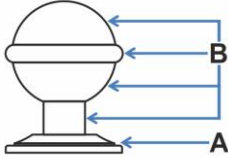
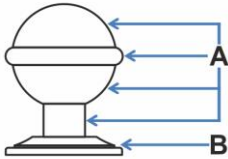
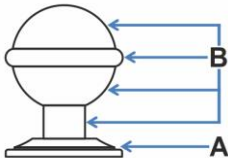
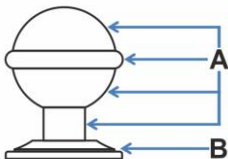
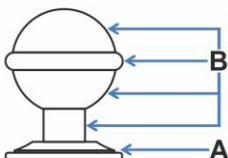
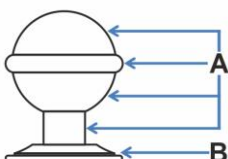
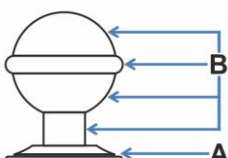
FINISH CODE (XX)	FINISH NAME	LINE DRAWING	A	B
KNB.604.XX.59A.RDB	Split Black and chrome with chrome back plate		Matte Black	Bright Chrome
KNB.604.XX.59B.RDB	Split Black and chrome / Black back plate		Matte Black	Bright Chrome
KNB.604.XX.60A.RDB	Split Satin Copper and Oil Rubbed Bronze with Satin Copper Back Plate		Oil Rubbed Bronze	Satin Copper
KNB.604.XX.60B.RDB	Split Satin Copper and Oil Rubbed Bronze with Oil Rubbed Bronze Back Plate		Oil Rubbed Bronze	Satin Copper
KNB.604.XX.75A.RDB	Split Aged Brass and English Metallic Bronze with Aged Brass Back Plate		English Metallic Bronze	Aged Brass
KNB.604.XX.75B.RDB	Split Aged Brass and English Metallic Bronze with English Metallic Bronze Back Plate		English Metallic Bronze	Aged Brass
KNB.604.XX.77A.RDB	Split Polished Nickel and Satin Brass with Satin Brass Back Plate		Polished Nickel	Satin Brass
KNB.604.XX.77B.RDB	Split Polished Nickel and Satin Brass with Polished Nickel Back Plate		Polished Nickel	Satin Brass

Rocher Knob With Round Back Plate Split Finish

KNB.604.XX.XX.RDB

FINISH CODE (XX)	FINISH NAME	LINE DRAWING	A	B
KNB.604.XX.78A.RDB	Split Brush Nickel and Satin Brass with Satin Brass Back Plate		Brush Nickel	Satin Brass
KNB.604.XX.78B.RDB	Split Brush Nickel and Satin Brass with Brush Nickel Back Plate		Brush Nickel	Satin Brass
KNB.604.XX.80A.RDB	Split Oil Rubbed Bronze and Satin Brass with Satin Brass Back Plate		Oil Rubbed Bronze	Satin Brass
KNB.604.XX.80B.RDB	Split Oil Rubbed Bronze and Satin Brass with Oil Rubbed Bronze Back Plate		Oil Rubbed Bronze	Satin Brass
KNB.604.XX.90A.RDB	Split Graphite and Satin Brass with Satin Brass Back Plate		Graphite	Satin Brass
KNB.604.XX.90B.RDB	Split Graphite and Satin Brass with Graphite Back Plate		Graphite	Satin Brass
KNB.604.XX.91A.RDB	Split Graphite and Brush Chrome with Brush Chrome Back Plate		Graphite	Brush Chrome
KNB.604.XX.91B.RDB	Split Graphite and Brush Chrome with Graphite Back Plate		Graphite	Brush Chrome



Oil Rubbed Bronze (Finish ID : 5)

BEAULIEU ROUND KNOB

“Form and function complemented by a clean and defined stepped edge detail well reflect different colour accents.”

	Item Code	Size (mm & Inches)	Material	Size (Inches)				Fig.
				A	B	C	D	
1	RDKNB.520.30.XX	30mm (1.18")	Brass	0.94	1.18	0.43	N/A	1
2	RDKNB.520.35.XX	35mm (1.38")	Brass	0.98	1.38	0.43	N/A	1
3	RDKNB.520.30.XX	30mm (1.18")	Bronze	0.98	1.24	0.47	N/A	1
4	RDKNB.520.35.XX	35mm (1.38")	Bronze	1.02	1.5	0.47	N/A	1
5	RDKNB.520.35.XX	30mm (1.18")	Cast Iron	0.98	1.26	0.47	N/A	1
6	RDKNB.520.35.XX	35mm (1.38")	Cast Iron	1.06	1.5	0.47	N/A	1

“XX” in item code denotes Finish ID.

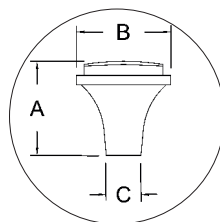
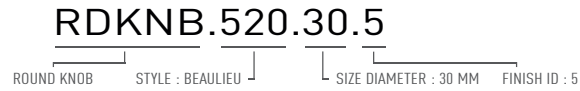

FIG. 1

This product is Supplied with M4x25mm screws.
This product is Supplied with M4x45mm break off screws.

How to Order



Beaulieu Round Knob Finish Options

Base Material : Cast Iron	
 Pewter (Finish ID:1)	
Base Material : Brass	Standard Finishes (2-3 Weeks Delivery)
 Bright Chrome (Finish ID:2)	
 Brush Nickel (Finish ID:3)	
 Aged Brass (Finish ID:4)	
 Oil Rubbed Bronze (Finish ID:5)	
 Untacquered Polished Brass (Finish ID:7U)	
 Polished Nickel (Finish ID:8)	
 Satin Brass (Finish ID:13)	
Base Material : Brass	Custom Finishes (3-4 Weeks Delivery)*
 Lacquered Polished Brass (Finish ID:7L)	
 Matte Black (Finish ID:19)	
 Graphite (Finish ID:61)	
 Ombre (Finish ID:92)	
 Brush Chrome (Finish ID:95)	
Base Material : Bronze	Custom Finishes (3-4 Weeks Delivery)*
 Silicon Bronze Light (Finish ID:53)	
 Silicon Bronze Dark (Finish ID:53D)	
 White Bronze (Finish ID:54)	

- Custom finishes cannot be returned or refunded. We are unable to accept cancellations for custom finish order unless within 48 hours of the order being placed.
- We have uniform pricing for all non-hammered finishes listed above as long as base material and size is same.
- Contact us for customized finishes, refer pages F1, F2, F3 & F4 for finish glossary.
- Backplate options refer page KBP1-1 to KBP14-1.



Brush Nickel (Finish ID:3)

BEAULIEU ROUND KNOB WITH ROUND BACK PLATE

“Form and function complemented by a clean and defined stepped edge detail well reflect different colour accents.”

	Item Code	Size (mm & Inches)	Material	Size (Inches)				Fig.
				A	B	C	D	
1	RDKNB.520.30.XX.RDB	30mm (1.18")	Brass	1.14	1.18	1.38	N/A	1
2	RDKNB.520.35.XX.RDB	35mm (1.38")	Brass	1.18	1.38	1.38	N/A	1
3	RDKNB.520.30.XX.RDB	30mm (1.18")	Cast Iron	1.18	1.26	1.38	N/A	1
4	RDKNB.520.35.XX.RDB	35mm (1.38")	Cast Iron	1.26	1.5	1.38	N/A	1
5	RDKNB.520.30.XX.RDB	30mm (1.18")	Bronze	1.18	1.24	1.38	N/A	1
6	RDKNB.520.35.XX.RDB	35mm (1.38")	Bronze	1.22	1.5	1.38	N/A	1

“XX” in item code denotes Finish ID.

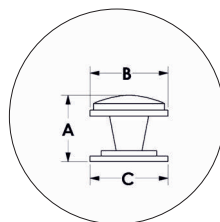
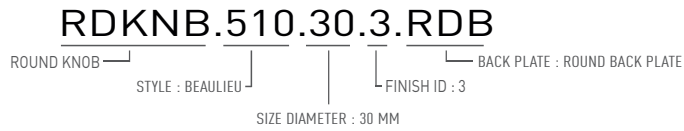

FIG. 1

This product is Supplied with M4x30mm screws.
This product is Supplied with M4x45mm break off screws.

How to Order



Beaulieu Round Knob With Round Back Plate Finish Options

Base Material : Cast Iron		Custom Finishes (3-4 Weeks Delivery)*				
 <p>Pewter (Finish ID:1)</p>						
Base Material : Brass		Standard Finishes (2-3 Weeks Delivery)				
 <p>Bright Chrome (Finish ID:2)</p>  <p>Brush Nickel (Finish ID:3)</p>  <p>Aged Brass (Finish ID:4)</p>  <p>Oil Rubbed Bronze (Finish ID:5)</p>  <p>Untacquered Polished Brass (Finish ID:7U)</p>  <p>Polished Nickel (Finish ID:8)</p>  <p>Satin Brass (Finish ID:13)</p>						
Base Material : Brass		Custom Finishes (3-4 Weeks Delivery)*				
 <p>Lacquered Polished Brass (Finish ID:7L)</p>  <p>Matte Black (Finish ID:19)</p>  <p>Graphite (Finish ID:61)</p>  <p>Ombre (Finish ID:92)</p>  <p>Brush Chrome (Finish ID:95)</p>						
Base Material : Bronze		Custom Finishes (3-4 Weeks Delivery)*				
 <p>Silicon Bronze Light (Finish ID:53)</p>  <p>Silicon Bronze Dark (Finish ID:53D)</p>  <p>White Bronze (Finish ID:54)</p>						

- Custom finishes cannot be returned or refunded. We are unable to accept cancellations for custom finish order unless within 48 hours of the order being placed.
- We have uniform pricing for all non-hammered finishes listed above as long as base material and size is same.
- Contact us for customized finishes, refer pages F1, F2, F3 & F4 for finish glossary.
- Backplate options refer page KBP1-1 to KBP14-1.



Brush Nickel (Finish ID : 3)

ROCHER KNOB WITH RECTANGULAR BACK PLATE

“Reflection of light from the rings increases Saturn's brightness, this could equally be describing the Rocher knob who's ring accentuates the light and contrast of the many finishes we can offer.”

	Item Code	Size (mm & Inches)	Material	Size (Inches)				Fig.
				A	B	C	D	
1	KNB.604.32.XX.RTB	32mm (1.26")	Brass	1.54	1.26	1.54	2.32	1
2	KNB.604.35.XX.RTB	35mm (1.38")	Brass	1.77	1.38	1.54	2.32	1
3	KNB.604.32.XX.RTB	32mm (1.26")	Hammered over Brass	1.54	1.26	1.54	2.32	1
4	KNB.604.35.XX.RTB	35mm (1.38")	Hammered over Brass	1.77	1.38	1.54	2.32	1

“XX” in item code denotes Finish ID.

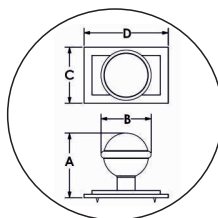
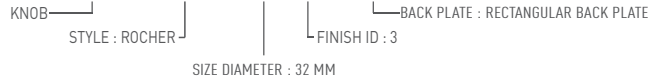

FIG. 1

This product is Supplied with M4x30mm screws.
This product is Supplied with M4x45mm break off screws.

How to Order



KNB.604.32.3.RTB



Rocher Knob With Rectangular Back Plate Finish Options

Base Material : Brass				Standard Finishes (2-3 Weeks Delivery)		
						
Bright Chrome (Finish ID:2)	Brush Nickel (Finish ID:3)	Aged Brass (Finish ID:4)	Oil Rubbed Bronze (Finish ID:5)	Unlacquered Polished Brass (Finish ID:7U)	Polished Nickel (Finish ID:8)	Satin Brass (Finish ID:13)
Base Material : Brass				Custom Finishes (3-4 Weeks Delivery)*		
						
Lacquered Polished Brass (Finish ID:7L)	Hammered over Brush Nickel (Finish ID:12-3)	Hammered over Aged Brass (Finish ID:12-4)	Hammered Over Oil Rubbed Bronze (Finish ID:12-5)	Hammered over Polished Nickel (Finish ID:12-8)	Hammered over Satin Brass (Finish ID:12-13)	Hammered over Rose Gold (Finish ID:12-33)
						
Matte Black (Finish ID:19)	Split Black and Polished Nickel with Polished Nickel Back Plate (Finish ID:48A)	Split Black and Polished Nickel with Black Back Plate (Finish ID:48B)	Split Black and Satin Brass with Satin Brass Back Plate (Finish ID:49A)	Split Black and Satin Brass with Black Back Plate (Finish ID:49B)	Split Satin Brass and White with Satin Brass Back Plate (Finish ID:50A)	Split Satin Brass and White with White Back Plate (Finish ID:50B)
						
English Metallic Bronze (Finish ID:51)	Split Polished Brass and Oil Rubbed Bronze with Polished Brass Back Plate (Finish ID:57A)	Split Polished Brass and Oil Rubbed Bronze with Oil Rubbed Bronze Back Plate (Finish ID:57B)	Split Satin Copper and Oil Rubbed Bronze with Satin Copper Back Plate (Finish ID:60A)	Split Satin Copper and Oil Rubbed Bronze with Oil Rubbed Bronze Back Plate (Finish ID:60B)	Graphite (Finish ID:61)	Split Aged Brass and English Metallic Bronze with Aged Brass Back Plate (Finish ID:75A)

- Custom finishes cannot be returned or refunded. We are unable to accept cancellations for custom finish order unless within 48 hours of the order being placed.
- We have uniform pricing for all non-hammered finishes listed above as long as base material and size is same.
- Contact us for customized finishes, refer pages F1, F2, F3 & F4 for finish glossary.
- Backplate options refer page KBP1-1 to KBP14-1.

Base Material : Brass		Custom Finishes (3-4 Weeks Delivery)*				
						
<p style="font-size: 8px;">Split Aged Brass and English Metallic Bronze with Satin Brass Back Plate (Finish ID:75B)</p>	<p style="font-size: 8px;">Split Polished Nickel and Satin Brass with Satin Brass Back Plate (Finish ID:77A)</p>	<p style="font-size: 8px;">Split Polished Nickel and Satin Brass with Polished Nickel Back Plate (Finish ID:77B)</p>	<p style="font-size: 8px;">Split Brush Nickel and Satin Brass with Satin Brass Back Plate (Finish ID:78A)</p>	<p style="font-size: 8px;">Split Brush Nickel and Satin Brass with Brush Nickel Back Plate (Finish ID:78B)</p>	<p style="font-size: 8px;">Split Oil Rubbed Bronze and Satin Brass with Satin Brass Back Plate (Finish ID:80A)</p>	<p style="font-size: 8px;">Split Oil Rubbed Bronze and Satin Brass with Oil Rubbed Bronze Back Plate (Finish ID:80B)</p>
						
<p style="font-size: 8px;">Split Graphite and Satin Brass with Satin Brass Back Plate (Finish ID:90A)</p>	<p style="font-size: 8px;">Split Graphite and Satin Brass with Graphite Back Plate (Finish ID:90B)</p>	<p style="font-size: 8px;">Split Graphite and Brush Chrome with Graphite Back Plate (Finish ID:91A)</p>	<p style="font-size: 8px;">Split Graphite and Brush Chrome with Brush Chrome Back Plate (Finish ID:91B)</p>	<p style="font-size: 8px;">Ombre (Finish ID:92)</p>	<p style="font-size: 8px;">Brush Chrome (Finish ID:95)</p>	

- Custom finishes cannot be returned or refunded. We are unable to accept cancellations for custom finish order unless within 48 hours of the order being placed.
- We have uniform pricing for all non-hammered finishes listed above as long as base material and size is same.
- Contact us for customized finishes, refer pages F1, F2, F3 & F4 for finish glossary.
- Backplate options refer page KBP1-1 to KBP14-1.

Rocher Knob With Rectangular Back Plate Split Finish

KNB.604.XX.XX.RTB

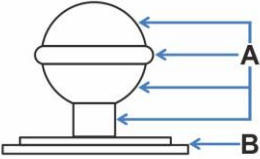
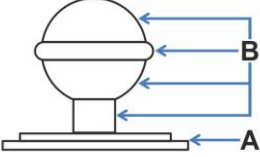
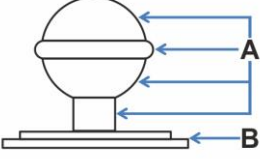
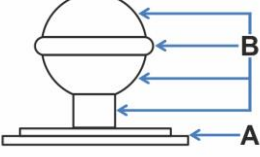
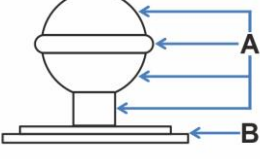
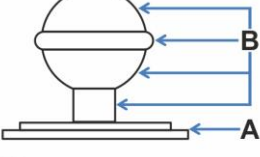
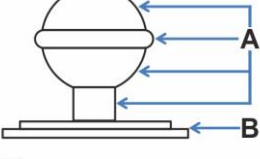
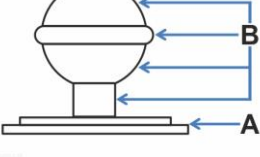
FINISH CODE (XX)	FINISH NAME	LINE DRAWING	A	B
KNB.604.XX.48A.RTB	Split Black and Nickel with Polished Nickel Back Plate		Matte Black	Polished Nickel
KNB.604.XX.48B.RTB	Split Black and Nickel with Black Back Plate		Matte Black	Polished Nickel
KNB.604.XX.49A.RTB	Split Black and Satin Brass with Satin Brass Back Plate		Matte Black	Satin Brass
KNB.604.XX.49B.RTB	Split Black and Satin Brass with Black Back Plate		Matte Black	Satin Brass
KNB.604.XX.50A.RTB	Split Satin Brass and White with Satin Brass Back Plate		White Epoxy	Satin Brass
KNB.604.XX.50B.RTB	Split Satin Brass and White with White Back Plate		White Epoxy	Satin Brass
KNB.604.XX.57A.RTB	Split Lacquered Polished Brass and Oil Rubbed Bronze with Lacquered Polished Brass Back Plate		Oil Rubbed Bronze	Lacquered Polished Brass
KNB.604.XX.57B.RTB	Split Lacquered Polished Brass and Oil Rubbed Bronze with Oil Rubbed Bronze Back Plate		Oil Rubbed Bronze	Lacquered Polished Brass

Rocher Knob With Rectangular Back Plate Split Finish

KNB.604.XX.XX.RTB

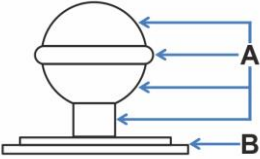
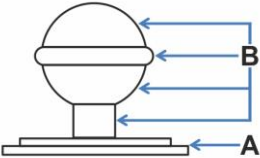
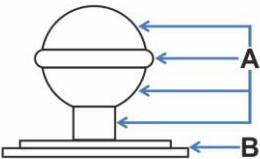
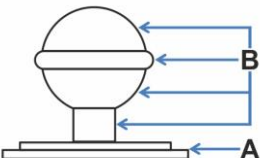
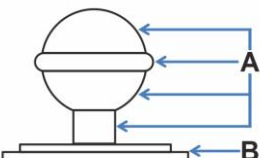
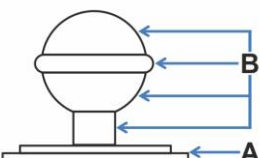
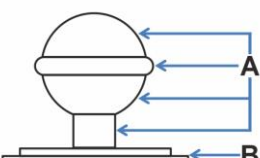
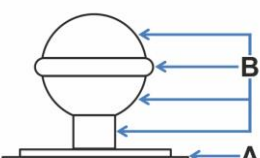
FINISH CODE (XX)	FINISH NAME	LINE DRAWING	A	B
KNB.604.XX.59A.RTB	Split Black and chrome with chrome back plate		Matte Black	Bright Chrome
KNB.604.XX.59B.RTB	Split Black and chrome / Black back plate		Matte Black	Bright Chrome
KNB.604.XX.60A.RTB	Split Satin Copper and Oil Rubbed Bronze with Satin Copper Back Plate		Oil Rubbed Bronze	Satin Copper
KNB.604.XX.60B.RTB	Split Satin Copper and Oil Rubbed Bronze with Oil Rubbed Bronze Back Plate		Oil Rubbed Bronze	Satin Copper
KNB.604.XX.75A.RTB	Split Aged Brass and English Metallic Bronze with Aged Brass Back Plate		English Metallic Bronze	Aged Brass
KNB.604.XX.75B.RTB	Split Aged Brass and English Metallic Bronze with English Metallic Bronze Back Plate		English Metallic Bronze	Aged Brass
KNB.604.XX.77A.RTB	Split Polished Nickel and Satin Brass with Satin Brass Back Plate		Polished Nickel	Satin Brass
KNB.604.XX.77B.RTB	Split Polished Nickel and Satin Brass with Polished Nickel Back Plate		Polished Nickel	Satin Brass

Rocher Knob With Rectangular Back Plate Split Finish

KNB.604.XX.XX.RTB

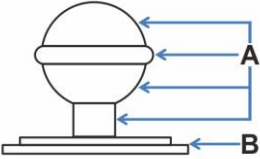
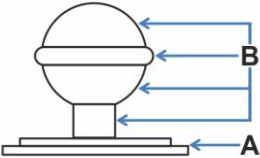
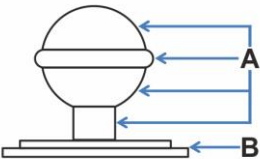
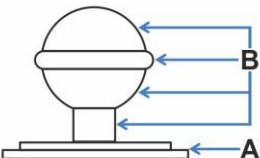
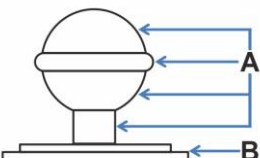
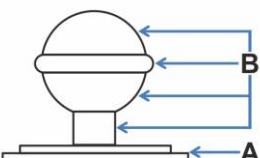
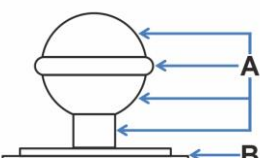
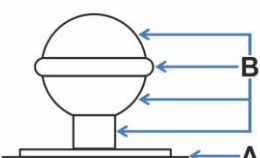
FINISH CODE (XX)	FINISH NAME	LINE DRAWING	A	B
KNB.604.XX.78A.RTB	Split Brush Nickel and Satin Brass with Satin Brass Back Plate		Brush Nickel	Satin Brass
KNB.604.XX.78B.RTB	Split Brush Nickel and Satin Brass with Brush Nickel Back Plate		Brush Nickel	Satin Brass
KNB.604.XX.80A.RTB	Split Oil Rubbed Bronze and Satin Brass with Satin Brass Back Plate		Oil Rubbed Bronze	Satin Brass
KNB.604.XX.80B.RTB	Split Oil Rubbed Bronze and Satin Brass with Oil Rubbed Bronze Back Plate		Oil Rubbed Bronze	Satin Brass
KNB.604.XX.90A.RTB	Split Graphite and Satin Brass with Satin Brass Back Plate		Graphite	Satin Brass
KNB.604.XX.90B.RTB	Split Graphite and Satin Brass with Graphite Back Plate		Graphite	Satin Brass
KNB.604.XX.91A.RTB	Split Graphite and Brush Chrome with Brush Chrome Back Plate		Graphite	Brush Chrome
KNB.604.XX.91B.RTB	Split Graphite and Brush Chrome with Graphite Back Plate		Graphite	Brush Chrome



Hammered over Brush Nickel (Finish ID : 12-3)

ROCHER KNOB

“Reflection of light from the rings increases Saturn's brightness, this could equally be describing the Rocher knob who's ring accentuates the light and contrast of the many finishes we can offer”

	Item Code	Size (mm & Inches)	Material	Size (Inches)				Fig.
				A	B	C	D	
1	KNB.604.32.XX	32mm (1.26")	Brass	1.34	1.26	N/A	N/A	1
2	KNB.604.35.XX	35mm (1.38")	Brass	1.57	1.38	N/A	N/A	1
3	KNB.604.32.XX	32mm (1.26")	Hammered over Brass	1.34	1.26	N/A	N/A	1
4	KNB.604.35.XX	35mm (1.38")	Hammered over Brass	1.57	1.38	N/A	N/A	1

“XX” in item code denotes Finish ID.

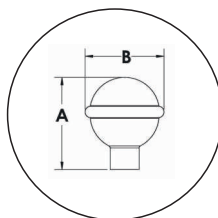

FIG. 1

This product is Supplied with M4x25mm screws.
This product is Supplied with M4x45mm break off screws.

How to Order

KNB.604.32.12-3

KNOB STYLE : ROCHER SIZE DIAMETER : 32 MM FINISH ID : 12-3

Rocher Knob Finish Options

Base Material : Brass		Standard Finishes (2-3 Weeks Delivery)				
						
Bright Chrome (Finish ID:2)	Brush Nickel (Finish ID:3)	Aged Brass (Finish ID:4)	Oil Rubbed Bronze (Finish ID:5)	Unlacquered Polished Brass (Finish ID:7U)	Polished Nickel (Finish ID:8)	Satin Brass (Finish ID:13)
Base Material : Brass		Custom Finishes (3-4 Weeks Delivery)*				
						
Lacquered Polished Brass (Finish ID:7L)	Hammered over Brush Nickel (Finish ID:12-3)	Hammered over Aged Brass (Finish ID:12-4)	Hammered Over Oil Rubbed Bronze (Finish ID:12-5)	Hammered over Polished Nickel (Finish ID:12-8)	Hammered over Satin Brass (Finish ID:12-13)	Hammered over Rose Gold (Finish ID:12-33)
						
Matte Black (Finish ID:19)	English Metallic Bronze (Finish ID:51)	Graphite (Finish ID:61)	Ombre (Finish ID:92)	Brush Chrome (Finish ID:95)		

- Custom finishes cannot be returned or refunded. We are unable to accept cancellations for custom finish order unless within 48 hours of the order being placed.
- We have uniform pricing for all non-hammered finishes listed above as long as base material and size is same.
- Contact us for customized finishes, refer pages F1, F2, F3 & F4 for finish glossary.
- Backplate options refer page KBP1-1 to KBP14-1.



Hammered over Oil Rubbed Bronze (Finish ID : 12-5)

ROCHER KNOB WITH SQUARE BACK PLATE

“Reflection of light from the rings increases Saturn's brightness, this could equally be describing the Rocher knob who's ring accentuates the light and contrast of the many finishes we can offer.”

	Item Code	Size (mm & Inches)	Material	Size (Inches)				Fig.
				A	B	C	D	
1	KNB.604.32.XX.SQB	32mm (1.26")	Brass	1.54	1.26	1.38	N/A	1
2	KNB.604.35.XX.SQB	35mm (1.38")	Brass	1.77	1.38	1.38	N/A	1
3	KNB.604.32.XX.SQB	32mm (1.26")	Hammered over Brass	1.54	1.26	1.38	N/A	1
4	KNB.604.35.XX.SQB	35mm (1.38")	Hammered over Brass	1.77	1.38	1.38	N/A	1

“XX” in item code denotes Finish ID.

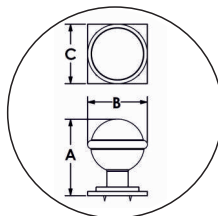

FIG. 1

This product is Supplied with M4x30mm screws.
This product is Supplied with M4x45mm break off screws.

How to Order

KNB.604.32.12-5.SQB



Rocher Knob With Square Back Plate Finish Options

Base Material : Brass				Standard Finishes (2-3 Weeks Delivery)		
						
Bright Chrome (Finish ID:2)	Brush Nickel (Finish ID:3)	Aged Brass (Finish ID:4)	Oil Rubbed Bronze (Finish ID:5)	Unlacquered Polished Brass (Finish ID:7U)	Polished Nickel (Finish ID:8)	Satin Brass (Finish ID:13)
Base Material : Brass				Custom Finishes (3-4 Weeks Delivery)*		
						
Lacquered Polished Brass (Finish ID:7L)	Hammered over Brush Nickel (Finish ID:12-3)	Hammered over Aged Brass (Finish ID:12-4)	Hammered Over Oil Rubbed Bronze (Finish ID:12-5)	Hammered over Polished Nickel (Finish ID:12-8)	Hammered over Satin Brass (Finish ID:12-13)	Hammered over Rose Gold (Finish ID:12-33)
						
Matte Black (Finish ID:19)	Split Black and Polished Nickel with Polished Nickel Back Plate (Finish ID:48A)	Split Black and Polished Nickel with Black Back Plate (Finish ID:48B)	Split Black and Satin Brass with Satin Brass Back Plate (Finish ID:49A)	Split Black and Satin Brass with Black Back Plate (Finish ID:49B)	Split Satin Brass and White with Satin Brass Back Plate (Finish ID:50A)	Split Satin Brass and White with White Back Plate (Finish ID:50B)
						
English Metallic Bronze (Finish ID:51)	Split Polished Brass and Oil Rubbed Bronze with Polished Brass Back Plate (Finish ID:57A)	Split Polished Brass and Oil Rubbed Bronze with Oil Rubbed Bronze Back Plate (Finish ID:57B)	Split Black and Chrome with Chrome Back Plate (Finish ID:59A)	Split Black and Chrome with Black Back Plate (Finish ID:59B)	Split Satin Copper and Oil Rubbed Bronze with Satin Copper Back Plate (Finish ID:60A)	Split Satin Copper and Oil Rubbed Bronze with Oil Rubbed Bronze Back Plate (Finish ID:60B)

- Custom finishes cannot be returned or refunded. We are unable to accept cancellations for custom finish order unless within 48 hours of the order being placed.
- We have uniform pricing for all non-hammered finishes listed above as long as base material and size is same.
- Contact us for customized finishes, refer pages F1, F2, F3 & F4 for finish glossary.
- Backplate options refer page KBP1-1 to KBP14-1.

Base Material : Brass	Custom Finishes (3-4 Weeks Delivery)*						
							
Graphite (Finish ID:61)	Split Aged Brass and English Metallic Bronze with Aged Brass Back Plate (Finish ID:75A)	Split Aged Brass and English Metallic Bronze with English Metallic Bronze Back Plate (Finish ID:75B)	Split Polished Nickel and Satin Brass with Satin Brass Back Plate (Finish ID:77A)	Split Polished Nickel and Satin Brass with Polished Nickel Back Plate (Finish ID:77B)	Split Brush Nickel and Satin Brass with Satin Brass Back Plate (Finish ID:78A)	Split Brush Nickel and Satin Brass with Brush Nickel Back Plate (Finish ID:78B)	
							
Split Oil Rubbed Bronze And Satin Brass with Satin Brass Back Plate (Finish ID:80A)	Split Oil Rubbed Bronze And Satin Brass with Oil Rubbed Bronze Back Plate (Finish ID:80B)	Split Graphite and Satin Brass with Satin Brass Back Plate (Finish ID:90A)	Split Graphite and Satin Brass with Graphite Back Plate (Finish ID:90B)	Split Graphite and Brush Chrome with Graphite Back Plate (Finish ID:91A)	Split Graphite and Brush Chrome with Brush Chrome Back Plate (Finish ID:91B)	Ombre (Finish ID:92)	
							
Brush Chrome (Finish ID:95)							

- Custom finishes cannot be returned or refunded. We are unable to accept cancellations for custom finish order unless within 48 hours of the order being placed.
- We have uniform pricing for all non-hammered finishes listed above as long as base material and size is same.
- Contact us for customized finishes, refer pages F1, F2, F3 & F4 for finish glossary.
- Backplate options refer page KBP1-1 to KBP14-1.

Rocher Knob With Square Back Plate Split Finish

KNB.604.XX.XX.SQB

FINISH CODE (XX)	FINISH NAME	LINE DRAWING	A	B
KNB.604.XX.48A.SQB	Split Black and Nickel with Polished Nickel Back Plate		Matte Black	Polished Nickel
KNB.604.XX.48B.SQB	Split Black and Nickel with Black Back Plate		Matte Black	Polished Nickel
KNB.604.XX.49A.SQB	Split Black and Satin Brass with Satin Brass Back Plate		Matte Black	Satin Brass
KNB.604.XX.49B.SQB	Split Black and Satin Brass with Black Back Plate		Matte Black	Satin Brass
KNB.604.XX.50A.SQB	Split Satin Brass and White with Satin Brass Back Plate		White Epoxy	Satin Brass
KNB.604.XX.50B.SQB	Split Satin Brass and White with White Back Plate		White Epoxy	Satin Brass
KNB.604.XX.57A.SQB	Split Lacquered Polished Brass and Oil Rubbed Bronze with Lacquered Polished Brass Back Plate		Oil Rubbed Bronze	Lacquered Polished Brass
KNB.604.XX.57B.SQB	Split Lacquered Polished Brass and Oil Rubbed Bronze with Oil Rubbed Bronze Back Plate		Oil Rubbed Bronze	Lacquered Polished Brass

Rocher Knob With Square Back Plate Split Finish

KNB.604.XX.XX.SQB

FINISH CODE (XX)	FINISH NAME	LINE DRAWING	A	B
KNB.604.XX.59A.SQB	Split Black and chrome with chrome back plate		Matte Black	Bright Chrome
KNB.604.XX.59B.SQB	Split Black and chrome / Black back plate		Matte Black	Bright Chrome
KNB.604.XX.60A.SQB	Split Satin Copper and Oil Rubbed Bronze with Satin Copper Back Plate		Oil Rubbed Bronze	Satin Copper
KNB.604.XX.60B.SQB	Split Satin Copper and Oil Rubbed Bronze with Oil Rubbed Bronze Back Plate		Oil Rubbed Bronze	Satin Copper
KNB.604.XX.75A.SQB	Split Aged Brass and English Metallic Bronze with Aged Brass Back Plate		English Metallic Bronze	Aged Brass
KNB.604.XX.75B.SQB	Split Aged Brass and English Metallic Bronze with English Metallic Bronze Back Plate		English Metallic Bronze	Aged Brass
KNB.604.XX.77A.SQB	Split Polished Nickel and Satin Brass with Satin Brass Back Plate		Polished Nickel	Satin Brass
KNB.604.XX.77B.SQB	Split Polished Nickel and Satin Brass with Polished Nickel Back Plate		Polished Nickel	Satin Brass

Rocher Knob With Square Back Plate Split Finish

KNB.604.XX.XX.SQB

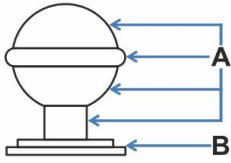
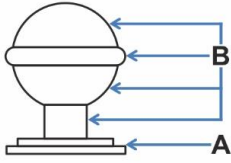
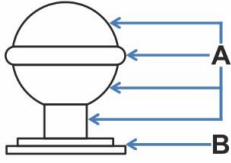
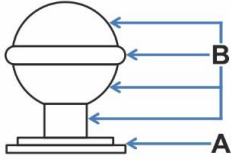
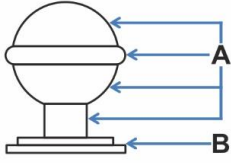
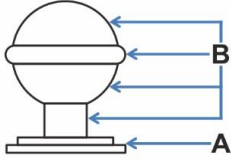
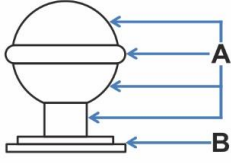
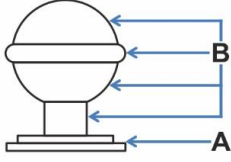
FINISH CODE (XX)	FINISH NAME	LINE DRAWING	A	B
KNB.604.XX.78A.SQB	Split Brush Nickel and Satin Brass with Satin Brass Back Plate		Brush Nickel	Satin Brass
KNB.604.XX.78B.SQB	Split Brush Nickel and Satin Brass with Brush Nickel Back Plate		Brush Nickel	Satin Brass
KNB.604.XX.80A.SQB	Split Oil Rubbed Bronze and Satin Brass with Satin Brass Back Plate		Oil Rubbed Bronze	Satin Brass
KNB.604.XX.80B.SQB	Split Oil Rubbed Bronze and Satin Brass with Oil Rubbed Bronze Back Plate		Oil Rubbed Bronze	Satin Brass
KNB.604.XX.90A.SQB	Split Graphite and Satin Brass with Satin Brass Back Plate		Graphite	Satin Brass
KNB.604.XX.90B.SQB	Split Graphite and Satin Brass with Graphite Back Plate		Graphite	Satin Brass
KNB.604.XX.91A.SQB	Split Graphite and Brush Chrome with Brush Chrome Back Plate		Graphite	Brush Chrome
KNB.604.XX.91B.SQB	Split Graphite and Brush Chrome with Graphite Back Plate		Graphite	Brush Chrome



Polished Nickel (Finish ID : 8)

BALLEY KNOB

“The smooth refined lines of the Balley knob could easily take its inspiration from a rose bud about the break into bloom, radiating light and colour.”

Item Code	Size (mm & Inches)	Material	Size (Inches)				Fig.
			A	B	C	D	
1 KNB.605.32.XX	32mm (1.26")	Brass	1.57	1.26	0.61	N/A	1

“XX” in item code denotes Finish ID.

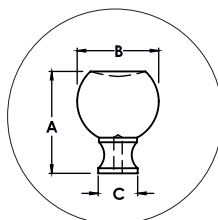

FIG. 1

This product is Supplied with M4x25mm screws.
This product is Supplied with M4x45mm break off screws.

How to Order

KNB.605.32.8

KNOB STYLE : BALLEY SIZE DIAMETER : 32 MM FINISH ID : 8

Balley Knob Finish Options

Base Material : Brass		Standard Finishes (2-3 Weeks Delivery)				
						
Bright Chrome (Finish ID:2)	Brush Nickel (Finish ID:3)	Aged Brass (Finish ID:4)	Oil Rubbed Bronze (Finish ID:5)	Unlacquered Polished Brass (Finish ID:7U)	Polished Nickel (Finish ID:8)	Satin Brass (Finish ID:13)
Base Material : Brass		Custom Finishes (3-4 Weeks Delivery)*				
						
Lacquered Polished Brass (Finish ID:7L)	Matte Black (Finish ID:19)	Ombre (Finish ID:92)	Brush Chrome (Finish ID:95)			

- Custom finishes cannot be returned or refunded. We are unable to accept cancellations for custom finish order unless within 48 hours of the order being placed.
- We have uniform pricing for all non-hammered finishes listed above as long as base material and size is same.
- Contact us for customized finishes, refer pages F1, F2, F3 & F4 for finish glossary.
- Backplate options refer page KBP1-1 to KBP14-1.



Satin Brass (Finish ID : 13)

BALLEY KNOB WITH ROUND BACK PLATE

“The smooth refined lines of the Balley knob could easily take its inspiration from a rose bud about the break into bloom, radiating light and colour.”

Item Code	Size (mm & Inches)	Material	Size (Inches)				Fig.
			A	B	C	D	
1 KNB.605.32.XX.RDB	32mm (1.26")	Brass	1.65	1.26	N/A	N/A	1

“XX” in item code denotes Finish ID.

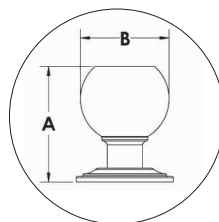
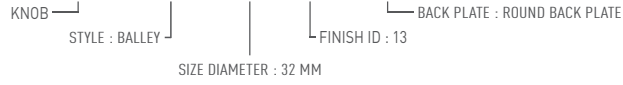

FIG. 1

This product is Supplied with M4x30mm screws.
This product is Supplied with M4x45mm break off screws.

How to Order

KNB.605.32.13.RDB



Balley Knob With Round Back Plate Finish Options

Base Material : Brass		Standard Finishes (2-3 Weeks Delivery)				
						
Bright Chrome (Finish ID:2)	Brush Nickel (Finish ID:3)	Aged Brass (Finish ID:4)	Oil Rubbed Bronze (Finish ID:5)	Unlacquered Polished Brass (Finish ID:7U)	Polished Nickel (Finish ID:8)	Satin Brass (Finish ID:13)
Base Material : Brass		Custom Finishes (3-4 Weeks Delivery)*				
						
Lacquered Polished Brass (Finish ID:7L)	Ombre (Finish ID:92)	Brush Chrome (Finish ID:95)				

- Custom finishes cannot be returned or refunded. We are unable to accept cancellations for custom finish order unless within 48 hours of the order being placed.
- We have uniform pricing for all non-hammered finishes listed above as long as base material and size is same.
- Contact us for customized finishes, refer pages F1, F2, F3 & F4 for finish glossary.
- Backplate options refer page KBP1-1 to KBP14-1.



Oil Rubbed Bronze (Finish ID : 5)

BALLEY KNOB WITH RECTANGULAR BACK PLATE

“The smooth refined lines of the Balley knob could easily take its inspiration from a rose bud about the break into bloom, radiating light and colour.”

Item Code	Size (mm & Inches)	Material	Size (Inches)				Fig.
			A	B	C	D	
1 KNB.605.32.XX.RTB	32mm (1.26")	Brass	1.65	1.26	1.54	2.32	1

“XX” in item code denotes Finish ID.

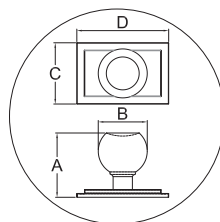
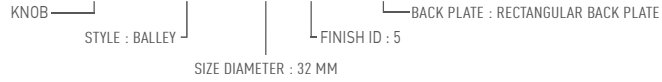

FIG. 1

This product is Supplied with M4x30mm screws.
This product is Supplied with M4x45mm break off screws.

How to Order

KNB.605.32.5.RTB



Balley Knob With Rectangular Back Plate Finish Options

Base Material : Brass		Standard Finishes (2-3 Weeks Delivery)				
						
Bright Chrome (Finish ID:2)	Brush Nickel (Finish ID:3)	Aged Brass (Finish ID:4)	Oil Rubbed Bronze (Finish ID:5)	Unlacquered Polished Brass (Finish ID:7U)	Polished Nickel (Finish ID:8)	Satin Brass (Finish ID:13)
Base Material : Brass		Custom Finishes (3-4 Weeks Delivery)*				
						
Lacquered Polished Brass (Finish ID:7L)	Ombre (Finish ID:92)	Brush Chrome (Finish ID:95)				

- Custom finishes cannot be returned or refunded. We are unable to accept cancellations for custom finish order unless within 48 hours of the order being placed.
- We have uniform pricing for all non-hammered finishes listed above as long as base material and size is same.
- Contact us for customized finishes, refer pages F1, F2, F3 & F4 for finish glossary.
- Backplate options refer page KBP1-1 to KBP14-1.



Brush Nickel (Finish ID : 3)

BALLEY KNOB WITH SQUARE BACK PLATE

“The smooth refined lines of the Balley knob could easily take its inspiration from a rose bud about the break into bloom, radiating light and colour.”

Item Code	Size (mm & Inches)	Material	Size (Inches)				Fig.
			A	B	C	D	
1 KNB.605.32.XX.SQB	32mm (1.26")	Brass	1.65	1.26	1.38	N/A	1

“XX” in item code denotes Finish ID.

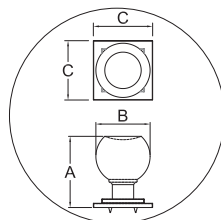
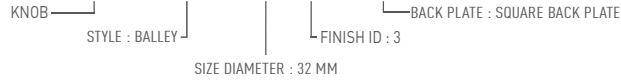

FIG. 1

This product is Supplied with M4x30mm screws.
This product is Supplied with M4x45mm break off screws.

How to Order

KNB.605.32.3.SQB



Balley Knob With Square Back Plate Finish Options

Base Material : Brass		Standard Finishes (2-3 Weeks Delivery)				
						
Bright Chrome (Finish ID:2)	Brush Nickel (Finish ID:3)	Aged Brass (Finish ID:4)	Oil Rubbed Bronze (Finish ID:5)	Unlacquered Polished Brass (Finish ID:7U)	Polished Nickel (Finish ID:8)	Satin Brass (Finish ID:13)
Base Material : Brass		Custom Finishes (3-4 Weeks Delivery)*				
						
Lacquered Polished Brass (Finish ID:7L)	Ombre (Finish ID:92)	Brush Chrome (Finish ID:95)				

- Custom finishes cannot be returned or refunded. We are unable to accept cancellations for custom finish order unless within 48 hours of the order being placed.
- We have uniform pricing for all non-hammered finishes listed above as long as base material and size is same.
- Contact us for customized finishes, refer pages F1, F2, F3 & F4 for finish glossary.
- Backplate options refer page KBP1-1 to KBP14-1.



Satin Brass (Finish ID : 13)

SULA KNOB WITH RECTANGULAR BACK PLATE

“The Sula shares its inspiration with a medieval chalice which is derived from the Latin word Calix also simply known as a decorative cup.”

	Item Code	Size (mm & Inches)	Material	Size (Inches)				Fig.
				A	B	C	D	
1	KNB.606.32.XX.RTB	32mm (1.26")	Brass	1.3	1.26	1.54	2.32	1
2	KNB.606.32.XX.RTB	32mm (1.26")	Hammered over Brass	1.3	1.26	1.54	2.32	1

“XX” in item code denotes Finish ID.

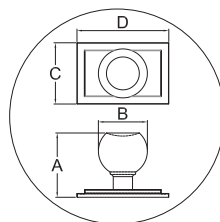
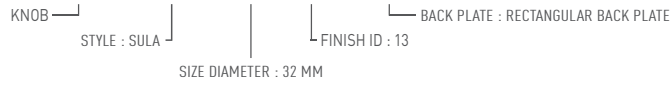

FIG. 1

This product is Supplied with M4x30mm screws.
This product is Supplied with M4x45mm break off screws.

How to Order

KNB.606.32.13.RTB



Sula Knob With Rectangular Back Plate Finish Options

Base Material : Brass		Standard Finishes (2-3 Weeks Delivery)				
						
Bright Chrome (Finish ID:2)	Brush Nickel (Finish ID:3)	Aged Brass (Finish ID:4)	Oil Rubbed Bronze (Finish ID:5)	Unlacquered Polished Brass (Finish ID:7U)	Polished Nickel (Finish ID:8)	Satin Brass (Finish ID:13)
Base Material : Brass		Custom Finishes (3-4 Weeks Delivery)*				
						
Lacquered Polished Brass (Finish ID:7L)	Hammered over Brush Nickel (Finish ID:12-3)	Hammered over Aged Brass (Finish ID:12-4)	Hammered Over Oil Rubbed Bronze (Finish ID:12-5)	Hammered over Polished Nickel (Finish ID:12-8)	Hammered over Satin Brass (Finish ID:12-13)	Hammered over Rose Gold (Finish ID:12-33)
						
Matte Black (Finish ID:19)	Satin Copper (Finish ID:58)	Graphite (Finish ID:61)	Titanium (Finish ID:79)	Ombre (Finish ID:92)	Brush Chrome (Finish ID:95)	

- Custom finishes cannot be returned or refunded. We are unable to accept cancellations for custom finish order unless within 48 hours of the order being placed.
- We have uniform pricing for all non-hammered finishes listed above as long as base material and size is same.
- Contact us for customized finishes, refer pages F1, F2, F3 & F4 for finish glossary.
- Backplate options refer page KBP1-1 to KBP14-1.



Polished Nickel (Finish ID : 8)

SULA KNOB

“The Sula shares its inspiration with a medieval chalice which is derived from the Latin word Calix also simply known as a decorative cup.”

	Item Code	Size (mm & Inches)	Material	Size (Inches)				Fig.
				A	B	C	D	
1	KNB.606.32.XX	32mm (1.26")	Brass	1.1	1.26	0.63	N/A	1
2	KNB.606.32.XX	32mm (1.26")	Hammered over Brass	1.1	1.26	0.63	N/A	1

“XX” in item code denotes Finish ID.

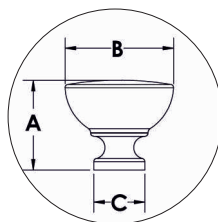

FIG. 1

This product is Supplied with M4x25mm screws.
This product is Supplied with M4x45mm break off screws.

How to Order

KNB.606.32.8

KNOB STYLE : SULA SIZE DIAMETER : 32 MM FINISH ID : 8

Sula Knob Finish Options

Base Material : Brass			Standard Finishes (2-3 Weeks Delivery)			
						
Bright Chrome (Finish ID:2)	Brush Nickel (Finish ID:3)	Aged Brass (Finish ID:4)	Oil Rubbed Bronze (Finish ID:5)	Unlacquered Polished Brass (Finish ID:7U)	Polished Nickel (Finish ID:8)	Satin Brass (Finish ID:13)
Base Material : Brass			Custom Finishes (3-4 Weeks Delivery)*			
						
Lacquered Polished Brass (Finish ID:7L)	Hammered over Brush Nickel (Finish ID:12-3)	Hammered over Aged Brass (Finish ID:12-4)	Hammered Over Oil Rubbed Bronze (Finish ID:12-5)	Hammered over Polished Nickel (Finish ID:12-8)	Hammered over Satin Brass (Finish ID:12-13)	Hammered over Rose Gold (Finish ID:12-33)
						
Matte Black (Finish ID:19)	Satin Copper (Finish ID:58)	Graphite (Finish ID:61)	Titanium (Finish ID:79)	Ombre (Finish ID:92)	Brush Chrome (Finish ID:95)	

- Custom finishes cannot be returned or refunded. We are unable to accept cancellations for custom finish order unless within 48 hours of the order being placed.
- We have uniform pricing for all non-hammered finishes listed above as long as base material and size is same.
- Contact us for customized finishes, refer pages F1, F2, F3 & F4 for finish glossary.
- Backplate options refer page KBP1-1 to KBP14-1.



Oil Rubbed Bronze (Finish ID : 5)

SULA KNOB WITH ROUND BACK PLATE

“The Sula shares its inspiration with a medieval chalice which is derived from the Latin word Calix also simply known as a decorative cup.”

	Item Code	Size (mm & Inches)	Material	Size (Inches)				Fig.
				A	B	C	D	
1	KNB.606.32.XX.RDB	32mm (1.26")	Brass	1.3	1.26	1.38	N/A	1
2	KNB.606.32.XX.RDB	32mm (1.26")	Hammered over Brass	1.3	1.26	1.38	N/A	1

“XX” in item code denotes Finish ID.

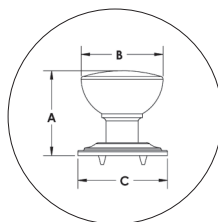
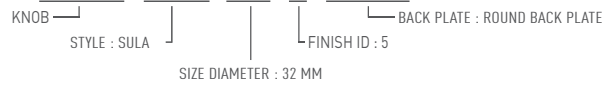

FIG. 1

This product is Supplied with M4x30mm screws.
This product is Supplied with M4x45mm break off screws.

How to Order

KNB.606.32.5.RDB



Sula Knob With Round Back Plate Finish Options

Base Material : Brass		Standard Finishes (2-3 Weeks Delivery)				
						
Bright Chrome (Finish ID:2)	Brush Nickel (Finish ID:3)	Aged Brass (Finish ID:4)	Oil Rubbed Bronze (Finish ID:5)	Unlacquered Polished Brass (Finish ID:7U)	Polished Nickel (Finish ID:8)	Satin Brass (Finish ID:13)
Base Material : Brass		Custom Finishes (3-4 Weeks Delivery)*				
						
Lacquered Polished Brass (Finish ID:7L)	Hammered over Brush Nickel (Finish ID:12-3)	Hammered over Aged Brass (Finish ID:12-4)	Hammered Over Oil Rubbed Bronze (Finish ID:12-5)	Hammered over Polished Nickel (Finish ID:12-8)	Hammered over Satin Brass (Finish ID:12-13)	Hammered over Rose Gold (Finish ID:12-33)
						
Matte Black (Finish ID:19)	Satin Copper (Finish ID:58)	Graphite (Finish ID:61)	Titanium (Finish ID:79)	Ombre (Finish ID:92)	Brush Chrome (Finish ID:95)	

- Custom finishes cannot be returned or refunded. We are unable to accept cancellations for custom finish order unless within 48 hours of the order being placed.
- We have uniform pricing for all non-hammered finishes listed above as long as base material and size is same.
- Contact us for customized finishes, refer pages F1, F2, F3 & F4 for finish glossary.
- Backplate options refer page KBP1-1 to KBP14-1.



Brush Nickel (Finish ID : 3)

SULA KNOB WITH SQUARE BACK PLATE

“The Sula shares its inspiration with a medieval chalice which is derived from the Latin word Calix also simply known as a decorative cup.”

	Item Code	Size (mm & Inches)	Material	Size (Inches)				Fig.
				A	B	C	D	
1	KNB.606.32.XX.SQB	32mm (1.26")	Brass	1.3	1.26	1.38	N/A	1
2	KNB.606.32.XX.SQB	32mm (1.26")	Hammered over Brass	1.3	1.26	1.38	N/A	1

“XX” in item code denotes Finish ID.

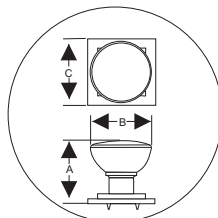
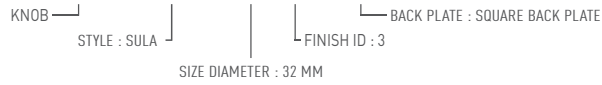

FIG. 1

This product is Supplied with M4x30mm screws.
This product is Supplied with M4x45mm break off screws.

How to Order

KNB.606.32.3.SQB



Sula Knob With Square Back Plate Finish Options

Base Material : Brass		Standard Finishes (2-3 Weeks Delivery)				
						
Bright Chrome (Finish ID:2)	Brush Nickel (Finish ID:3)	Aged Brass (Finish ID:4)	Oil Rubbed Bronze (Finish ID:5)	Unlacquered Polished Brass (Finish ID:7U)	Polished Nickel (Finish ID:8)	Satin Brass (Finish ID:13)
Base Material : Brass		Custom Finishes (3-4 Weeks Delivery)*				
						
Lacquered Polished Brass (Finish ID:7L)	Hammered over Brush Nickel (Finish ID:12-3)	Hammered over Aged Brass (Finish ID:12-4)	Hammered Over Oil Rubbed Bronze (Finish ID:12-5)	Hammered over Polished Nickel (Finish ID:12-8)	Hammered over Satin Brass (Finish ID:12-13)	Hammered over Rose Gold (Finish ID:12-33)
						
Matte Black (Finish ID:19)	Satin Copper (Finish ID:58)	Graphite (Finish ID:61)	Titanium (Finish ID:79)	Ombre (Finish ID:92)	Brush Chrome (Finish ID:95)	

- Custom finishes cannot be returned or refunded. We are unable to accept cancellations for custom finish order unless within 48 hours of the order being placed.
- We have uniform pricing for all non-hammered finishes listed above as long as base material and size is same.
- Contact us for customized finishes, refer pages F1, F2, F3 & F4 for finish glossary.
- Backplate options refer page KBP1-1 to KBP14-1.

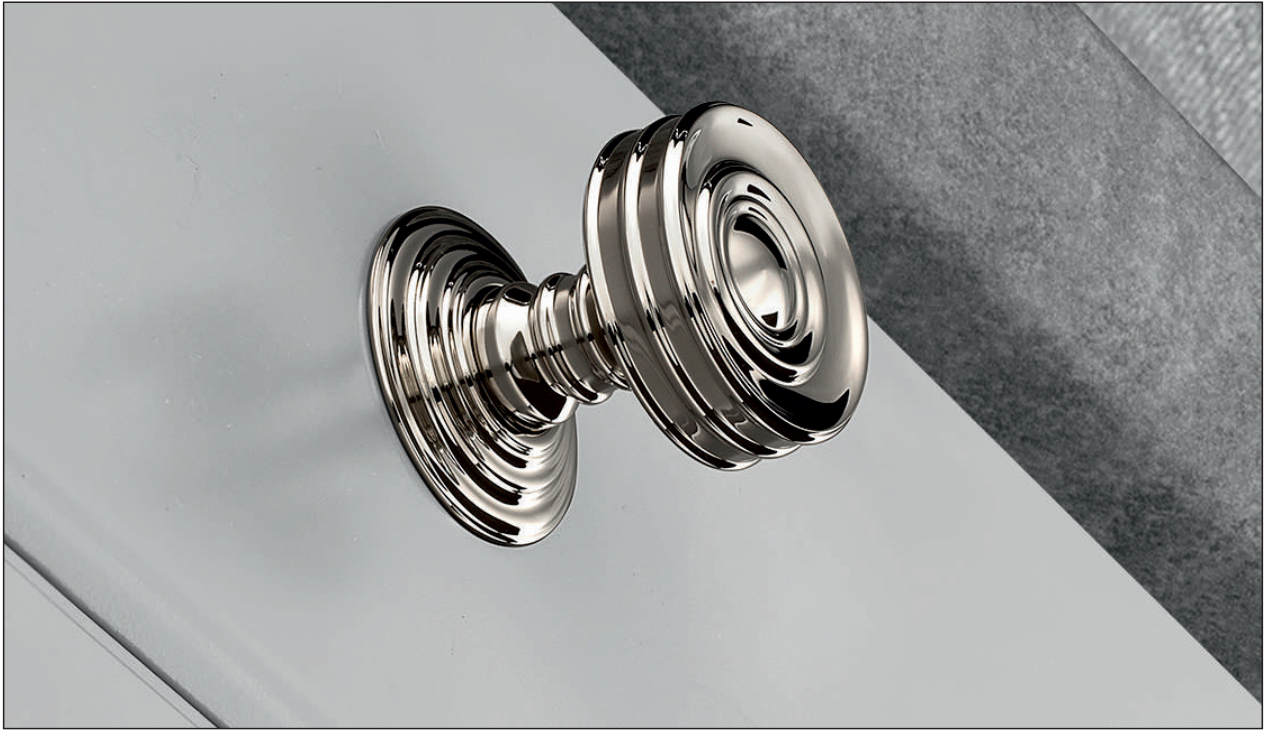

Polished Nickel (Finish ID : 8)

BORDEAUX KNOB WITH BACK PLATE

	Item Code	Size (mm & Inches)	Material	Size (Inches)				Fig.
				A	B	C	D	
1	KNB.607.25.XX	25mm (0.98")	Brass	1.02	0.98	N/A	N/A	1
2	KNB.607.32.XX	32mm (1.26")	Brass	1.23	1.26	N/A	N/A	1
3	KNB.607.38.XX	38mm (1.5")	Brass	1.54	1.5	N/A	N/A	1

"XX" in item code denotes Finish ID.

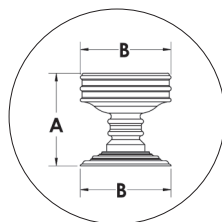

FIG. 1

This product is Supplied with M4x30mm screws.
This product is Supplied with M4x45mm break off screws.

How to Order

KNB.607.25.8

KNOB STYLE : BORDEAUX WITH BACK PLATE SIZE DIAMETER : 25 MM FINISH ID : 8

Bordeaux Knob With Back Plate Finish Options

Base Material : Brass		Standard Finishes (2-3 Weeks Delivery)				
						
Bright Chrome (Finish ID:2)	Brush Nickel (Finish ID:3)	Aged Brass (Finish ID:4)	Oil Rubbed Bronze (Finish ID:5)	Unlacquered Polished Brass (Finish ID:7U)	Polished Nickel (Finish ID:8)	Satin Brass (Finish ID:13)
Base Material : Brass		Custom Finishes (3-4 Weeks Delivery)*				
						
Lacquered Polished Brass (Finish ID:7L)	Ombre (Finish ID:92)	Brush Chrome (Finish ID:95)				

- Custom finishes cannot be returned or refunded. We are unable to accept cancellations for custom finish order unless within 48 hours of the order being placed.
- We have uniform pricing for all non-hammered finishes listed above as long as base material and size is same.
- Contact us for customized finishes, refer pages F1, F2, F3 & F4 for finish glossary.
- Backplate options refer page KBP1-1 to KBP14-1.



Polished Nickel (Finish ID : 8)

STUDIO KNOB WITH BACK PLATE

“Seeking inspiration from shape and form of a Tabor the English variation of the Latin word for drum. Simple symmetry reflects light onto its surroundings.”

	Item Code	Size (mm & Inches)	Material	Size (Inches)				Fig.
				A	B	C	D	
1	KNB.608.25.XX	25mm (0.98")	Brass	0.83	0.98	0.98	N/A	1
2	KNB.608.32.XX	32mm (1.26")	Brass	1.15	1.26	1.26	N/A	1
3	KNB.608.38.XX	38mm (1.5")	Brass	1.46	1.5	1.5	N/A	1

“XX” in item code denotes Finish ID.

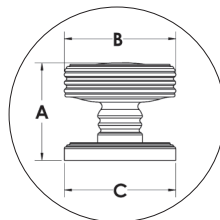

FIG. 1



























This product is Supplied with M4x30mm screws.
This product is Supplied with M4x45mm break off screws.

How to Order

KNB.608.25.8

KNOB STYLE : STUDIO KNOB WITH BACK PLATE SIZE DIAMETER : 25 MM FINISH ID : 8

Studio Knob With Back Plate Finish Options

Base Material : Brass		Standard Finishes (2-3 Weeks Delivery)				
						
Bright Chrome (Finish ID:2)	Brush Nickel (Finish ID:3)	Aged Brass (Finish ID:4)	Oil Rubbed Bronze (Finish ID:5)	Unlacquered Polished Brass (Finish ID:7U)	Polished Nickel (Finish ID:8)	Satin Brass (Finish ID:13)
Base Material : Brass		Custom Finishes (3-4 Weeks Delivery)*				
						
Lacquered Polished Brass (Finish ID:7L)	Antique Copper (Finish ID:15)	Matte Black (Finish ID:19)	Split Black and Polished Nickel with Polished Nickel Back Plate (Finish ID:48A)	Split Black and Polished Nickel with Black Back Plate (Finish ID:48B)	Split Black and Satin Brass with Satin Brass Back Plate (Finish ID:49A)	Split Black and Satin Brass with Black Back Plate (Finish ID:49B)
						
Split Satin Brass and White with Satin Brass Back Plate (Finish ID:50A)	Split Satin Brass and White with White Back Plate (Finish ID:50B)	English Metallic Bronze (Finish ID:51)	Split Polished Brass and Oil Rubbed Bronze with Polished Brass Back Plate (Finish ID:57A)	Split Polished Brass and Oil Rubbed Bronze with Oil Rubbed Bronze Back Plate (Finish ID:57B)	Satin Copper (Finish ID:58)	Split Black and Chrome with Chrome Back Plate (Finish ID:59A)
						
Split Black and Chrome with Black Back Plate (Finish ID:59B)	Split Satin Copper and Oil Rubbed Bronze with Satin Copper Back Plate (Finish ID:60A)	Split Satin Copper and Oil Rubbed Bronze with Oil Rubbed Bronze Back Plate (Finish ID:60B)	Graphite (Finish ID:61)	Split Aged Brass and English Metallic Bronze with Aged Brass Back Plate (Finish ID:75A)	Split Aged Brass and English Metallic Bronze with English Metallic Bronze Back Plate (Finish ID:75B)	Split Polished Nickel and Satin Brass with Satin Brass Back Plate (Finish ID:77A)

- Custom finishes cannot be returned or refunded. We are unable to accept cancellations for custom finish order unless within 48 hours of the order being placed.
- We have uniform pricing for all non-hammered finishes listed above as long as base material and size is same.
- Contact us for customized finishes, refer pages F1, F2, F3 & F4 for finish glossary.
- Backplate options refer page KBP1-1 to KBP14-1.

Base Material : Brass		Standard Finishes (2-3 Weeks Delivery)				
 Split Polished Nickel and Satin Brass with Polished Nickel Back Plate (Finish ID:77B)	 Split Brush Nickel and Satin Brass with Satin Brass Back Plate (Finish ID:78A)	 Split Brush Nickel and Satin Brass with Brush Nickel Back Plate (Finish ID:78B)	 Titanium (Finish ID:79)	 Split Oil Rubbed Bronze And Satin Brass with Satin Brass Back Plate (Finish ID:80A)	 Split Oil Rubbed Bronze And Satin Brass with Oil Rubbed Bronze Back Plate (Finish ID:80B)	 Split Graphite and Satin Brass with Satin Brass Back Plate (Finish ID:90A)
 Split Graphite and Satin Brass with Graphite Back Plate (Finish ID:90B)	 Split Graphite and Brush Chrome with Graphite Back Plate (Finish ID:91A)	 Split Graphite and Brush Chrome with Brush Chrome Back Plate (Finish ID:91B)	 Ombre (Finish ID:92)	 Brush Chrome (Finish ID:95)		

- Custom finishes cannot be returned or refunded. We are unable to accept cancellations for custom finish order unless within 48 hours of the order being placed.
- We have uniform pricing for all non-hammered finishes listed above as long as base material and size is same.
- Contact us for customized finishes, refer pages F1, F2, F3 & F4 for finish glossary.
- Backplate options refer page KBP1-1 to KBP14-1.

Studio Knob with Round Back Plate Split Finish

KNB.608.XX.XX

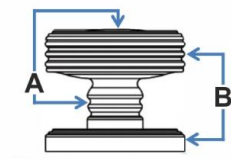
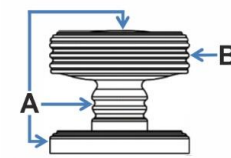
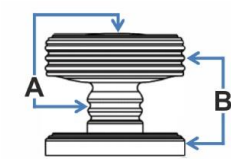
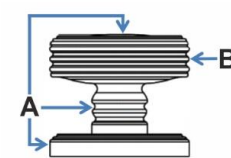
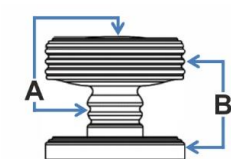
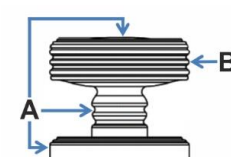
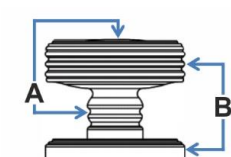
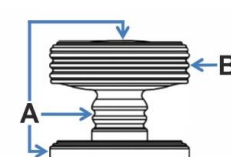
FINISH CODE (XX)	FINISH NAME	LINE DRAWING	A	B
KNB.608.XX.48A	Split Black and Nickel with Polished Nickel Back Plate		Matte Black	Polished Nickel
KNB.608.XX.48B	Split Black and Nickel with Black Back Plate		Matte Black	Polished Nickel
KNB.608.XX.49A	Split Black and Satin Brass with Satin Brass Back Plate		Matte Black	Satin Brass
KNB.608.XX.49B	Split Black and Satin Brass with Black Back Plate		Matte Black	Satin Brass
KNB.608.XX.50A	Split Satin Brass and White with Satin Brass Back Plate		White Epoxy	Satin Brass
KNB.608.XX.50B	Split Satin Brass and White with White Back Plate		White Epoxy	Satin Brass
KNB.608.XX.57A	Split Lacquered Polished Brass and Oil Rubbed Bronze with Lacquered Polished Brass Back Plate		Oil Rubbed Bronze	Lacquered Polished Brass
KNB.608.XX.57B	Split Lacquered Polished Brass and Oil Rubbed Bronze with Oil Rubbed Bronze Back Plate		Oil Rubbed Bronze	Lacquered Polished Brass

Studio Knob with Round Back Plate Split Finish

KNB.608.XX.XX

FINISH CODE (XX)	FINISH NAME	LINE DRAWING	A	B
KNB.608.XX.59A	Split Black and chrome with chrome back plate		Matte Black	Bright Chrome
KNB.608.XX.59B	Split Black and chrome / Black back plate		Matte Black	Bright Chrome
KNB.608.XX.60A	Split Satin Copper and Oil Rubbed Bronze with Satin Copper Back Plate		Oil Rubbed Bronze	Satin Copper
KNB.608.XX.60B	Split Satin Copper and Oil Rubbed Bronze with Oil Rubbed Bronze Back Plate		Oil Rubbed Bronze	Satin Copper
KNB.608.XX.75A	Split Aged Brass and English Metallic Bronze with Aged Brass Back Plate		English Metallic Bronze	Aged Brass
KNB.608.XX.75B	Split Aged Brass and English Metallic Bronze with English Metallic Bronze Back Plate		English Metallic Bronze	Aged Brass
KNB.608.XX.77A	Split Polished Nickel and Satin Brass with Satin Brass Back Plate		Polished Nickel	Satin Brass
KNB.608.XX.77B	Split Polished Nickel and Satin Brass with Polished Nickel Back Plate		Polished Nickel	Satin Brass

Studio Knob with Round Back Plate Split Finish

KNB.608.XX.XX

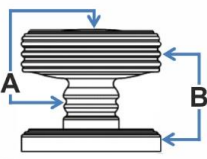
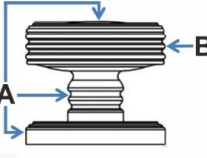
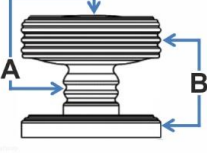
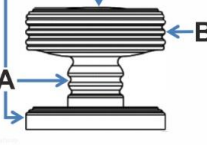
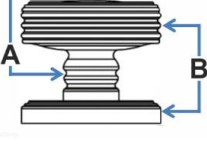
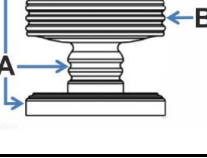
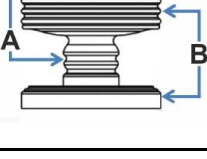
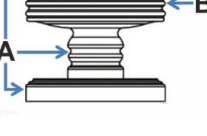
FINISH CODE (XX)	FINISH NAME	LINE DRAWING	A	B
KNB.608.XX.78A	Split Brush Nickel and Satin Brass with Satin Brass Back Plate		Brush Nickel	Satin Brass
KNB.608.XX.78B	Split Brush Nickel and Satin Brass with Brush Nickel Back Plate		Brush Nickel	Satin Brass
KNB.608.XX.80A	Split Oil Rubbed Bronze and Satin Brass with Satin Brass Back Plate		Oil Rubbed Bronze	Satin Brass
KNB.608.XX.80B	Split Oil Rubbed Bronze and Satin Brass with Oil Rubbed Bronze Back Plate		Oil Rubbed Bronze	Satin Brass
KNB.608.XX.90A	Split Graphite and Satin Brass with Satin Brass Back Plate		Graphite	Satin Brass
KNB.608.XX.90B	Split Graphite and Satin Brass with Graphite Back Plate		Graphite	Satin Brass
KNB.608.XX.91A	Split Graphite and Brush Chrome with Brush Chrome Back Plate		Graphite	Brush Chrome
KNB.608.XX.91B	Split Graphite and Brush Chrome with Graphite Back Plate		Graphite	Brush Chrome

M Y O H
MAKE YOUR OWN HOME



Bright Chrome (Finish ID : 2)

ART DECO KNOB WITH BACK PLATE

	Item Code	Size (mm & Inches)	Material	Size (Inches)				Fig.
				A	B	C	D	
1	KNB.609.25.XX	25mm (0.98")	Brass	0.93	0.98	0.98	N/A	1
2	KNB.609.32.XX	32mm (1.26")	Brass	1	1.26	1.26	N/A	1
3	KNB.609.38.XX	38mm (1.5")	Brass	1.32	1.5	1.5	N/A	1

"XX" in item code denotes Finish ID.

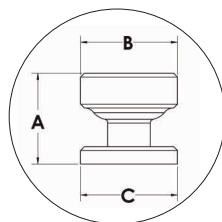

FIG. 1



This product is Supplied with M4x30mm screws.
This product is Supplied with M4x45mm break off screws.

How to Order

KNB.609.25.2

KNOB STYLE : ART DECO WITH BACK PLATE SIZE DIAMETER : 25 MM FINISH ID : 2

Art Deco Knob With Back Plate Finish Options

Base Material : Brass		Standard Finishes (2-3 Weeks Delivery)				
						
Bright Chrome (Finish ID:2)	Brush Nickel (Finish ID:3)	Oil Rubbed Bronze (Finish ID:5)	Polished Nickel (Finish ID:8)	Satin Brass (Finish ID:13)		
Base Material : Brass		Custom Finishes (3-4 Weeks Delivery)*				
						
Matte Black (Finish ID:19)	Split Black and Polished Nickel with Polished Nickel Back Plate (Finish ID:48A)	Split Black and Polished Nickel with Black Back Plate (Finish ID:48B)	Split Black and Satin Brass with Satin Brass Back Plate (Finish ID:49A)	Split Black and Satin Brass with Black Back Plate (Finish ID:49B)	Split Satin Brass and White with Satin Brass Back Plate (Finish ID:50A)	Split Satin Brass and White with White Back Plate (Finish ID:50B)
						
English Metallic Bronze (Finish ID:51)	Split Polished Brass and Oil Rubbed Bronze with Polished Brass Back Plate (Finish ID:57A)	Split Polished Brass and Oil Rubbed Bronze with Oil Rubbed Bronze Back Plate (Finish ID:57B)	Split Black and Chrome with Chrome Back Plate (Finish ID:59A)	Split Black and Chrome with Black Back Plate (Finish ID:59B)	Split Satin Copper and Oil Rubbed Bronze with Satin Copper Back Plate (Finish ID:60A)	Split Satin Copper and Oil Rubbed Bronze with Oil Rubbed Bronze Back Plate (Finish ID:60B)
						
Graphite (Finish ID:61)	Split Aged Brass and English Metallic Bronze with Aged Brass Back Plate (Finish ID:75A)	Split Aged Brass and English Metallic Bronze with English Metallic Bronze Back Plate (Finish ID:75B)	Split Polished Nickel and Satin Brass with Satin Brass Back Plate (Finish ID:77A)	Split Polished Nickel and Satin Brass with Polished Nickel Back Plate (Finish ID:77B)	Split Brush Nickel and Satin Brass with Satin Brass Back Plate (Finish ID:78A)	Split Brush Nickel and Satin Brass with Brush Nickel Back Plate (Finish ID:78B)

- Custom finishes cannot be returned or refunded. We are unable to accept cancellations for custom finish order unless within 48 hours of the order being placed.
- We have uniform pricing for all non-hammered finishes listed above as long as base material and size is same.
- Contact us for customized finishes, refer pages F1, F2, F3 & F4 for finish glossary.
- Backplate options refer page KBP1-1 to KBP14-1.

Base Material : Brass		Custom Finishes (3-4 Weeks Delivery)*				
 Titanium (Finish ID:79)	 Split Oil Rubbed Bronze And Satin Brass with Satin Brass Back Plate (Finish ID:80A)	 Split Oil Rubbed Bronze And Satin Brass with Oil Rubbed Bronze Back Plate (Finish ID:80B)	 Split Graphite and Satin Brass with Satin Brass Back Plate (Finish ID:90A)	 Split Graphite and Satin Brass with Graphite Back Plate (Finish ID:90B)	 Split Graphite and Brush Chrome with Graphite Back Plate (Finish ID:91A)	 Split Graphite and Brush Chrome with Brush Chrome Back Plate (Finish ID:91B)
 Ombre (Finish ID:92)	 Brush Chrome (Finish ID:95)					

- Custom finishes cannot be returned or refunded. We are unable to accept cancellations for custom finish order unless within 48 hours of the order being placed.
- We have uniform pricing for all non-hammered finishes listed above as long as base material and size is same.
- Contact us for customized finishes, refer pages F1, F2, F3 & F4 for finish glossary.
- Backplate options refer page KBP1-1 to KBP14-1.

Art Deco Knob Split Finish

KNB.609.XX.XX

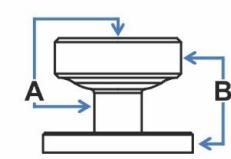
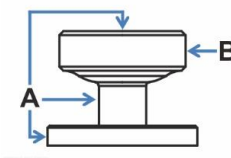
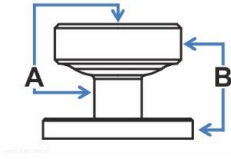
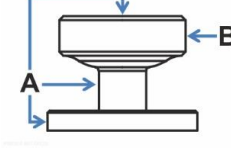
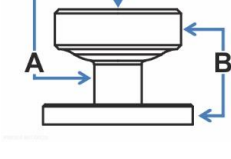
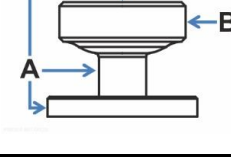
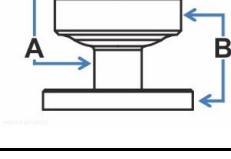
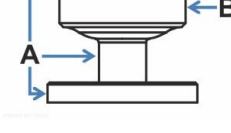
FINISH CODE (XX)	FINISH NAME	LINE DRAWING	A	B
KNB.609.XX.48A	Split Black and Nickel with Polished Nickel Back Plate		Matte Black	Polished Nickel
KNB.609.XX.48B	Split Black and Nickel with Black Back Plate		Matte Black	Polished Nickel
KNB.609.XX.49A	Split Black and Satin Brass with Satin Brass Back Plate		Matte Black	Satin Brass
KNB.609.XX.49B	Split Black and Satin Brass with Black Back Plate		Matte Black	Satin Brass
KNB.609.XX.50A	Split Satin Brass and White with Satin Brass Back Plate		White Epoxy	Satin Brass
KNB.609.XX.50B	Split Satin Brass and White with White Back Plate		White Epoxy	Satin Brass
KNB.609.XX.57A	Split Lacquered Polished Brass and Oil Rubbed Bronze with Lacquered Polished Brass Back Plate		Oil Rubbed Bronze	Lacquered Polished Brass
KNB.609.XX.57B	Split Lacquered Polished Brass and Oil Rubbed Bronze with Oil Rubbed Bronze Back Plate		Oil Rubbed Bronze	Lacquered Polished Brass

Art Deco Knob Split Finish

KNB.609.XX.XX

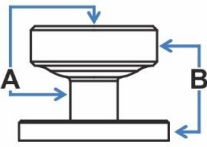
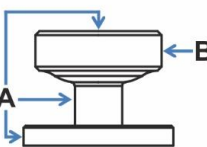
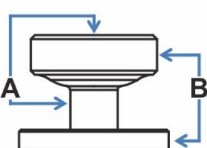
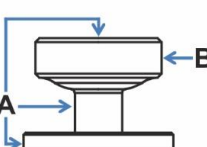
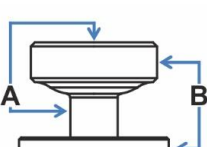
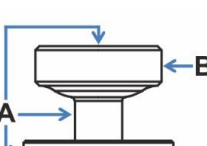
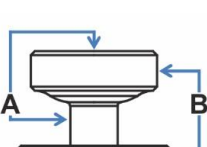
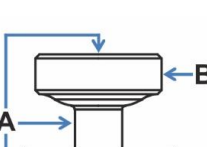
FINISH CODE (XX)	FINISH NAME	LINE DRAWING	A	B
KNB.609.XX.59A	Split Black and chrome with chrome back plate		Matte Black	Bright Chrome
KNB.609.XX.59B	Split Black and chrome / Black back plate		Matte Black	Bright Chrome
KNB.609.XX.60A	Split Satin Copper and Oil Rubbed Bronze with Satin Copper Back Plate		Oil Rubbed Bronze	Satin Copper
KNB.609.XX.60B	Split Satin Copper and Oil Rubbed Bronze with Oil Rubbed Bronze Back Plate		Oil Rubbed Bronze	Satin Copper
KNB.609.XX.75A	Split Aged Brass and English Metallic Bronze with Aged Brass Back Plate		English Metallic Bronze	Aged Brass
KNB.609.XX.75B	Split Aged Brass and English Metallic Bronze with English Metallic Bronze Back Plate		English Metallic Bronze	Aged Brass
KNB.609.XX.77A	Split Polished Nickel and Satin Brass with Satin Brass Back Plate		Polished Nickel	Satin Brass
KNB.609.XX.77B	Split Polished Nickel and Satin Brass with Polished Nickel Back Plate		Polished Nickel	Satin Brass

Art Deco Knob Split Finish

KNB.609.XX.XX

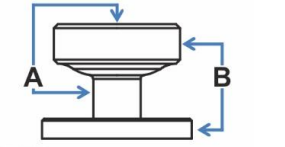
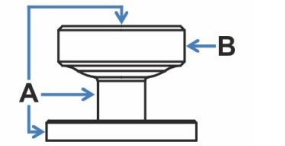
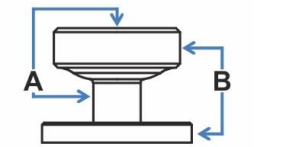
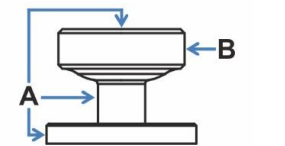
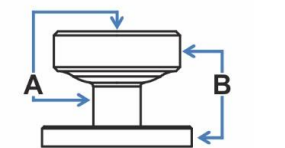
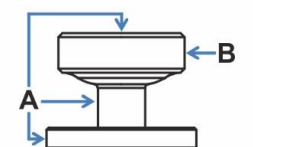
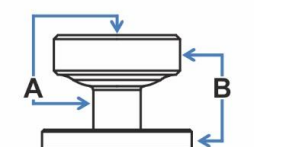
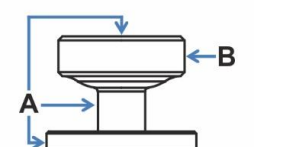
FINISH CODE (XX)	FINISH NAME	LINE DRAWING	A	B
KNB.609.XX.78A	Split Brush Nickel and Satin Brass with Satin Brass Back Plate		Brush Nickel	Satin Brass
KNB.609.XX.78B	Split Brush Nickel and Satin Brass with Brush Nickel Back Plate		Brush Nickel	Satin Brass
KNB.609.XX.80A	Split Oil Rubbed Bronze and Satin Brass with Satin Brass Back Plate		Oil Rubbed Bronze	Satin Brass
KNB.609.XX.80B	Split Oil Rubbed Bronze and Satin Brass with Oil Rubbed Bronze Back Plate		Oil Rubbed Bronze	Satin Brass
KNB.609.XX.90A	Split Graphite and Satin Brass with Satin Brass Back Plate		Graphite	Satin Brass
KNB.609.XX.90B	Split Graphite and Satin Brass with Graphite Back Plate		Graphite	Satin Brass
KNB.609.XX.91A	Split Graphite and Brush Chrome with Brush Chrome Back Plate		Graphite	Brush Chrome
KNB.609.XX.91B	Split Graphite and Brush Chrome with Graphite Back Plate		Graphite	Brush Chrome



Hammered Over Polished Nickel (Finish ID:12-8)

HAUTE KNOB

	Item Code	Size (mm & Inches)	Material	Size (Inches)				Fig.
				A	B	C	D	
1	KNB.614.25.XX	25mm (0.98")	Brass	1.57	0.83	0.87	N/A	1
2	KNB.614.32.XX	32mm (1.26")	Brass	1.81	1.1	1.14	N/A	1
3	KNB.614.25.XX	25mm (0.98")	Hammered over Brass	1.57	0.83	0.87	N/A	1
4	KNB.614.32.XX	32mm (1.26")	Hammered over Brass	1.81	1.1	1.14	N/A	1

"XX" in item code denotes Finish ID.

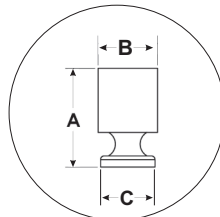

FIG. 1











This product is Supplied with M4x25mm screws.
This product is Supplied with M4x45mm break off screws.

How to Order

KNB.614.25.12-8

KNOB STYLE : HAUTE SIZE DIAMETER : 25 MM FINISH ID : 12-8

Haute Knob Finish Options

Base Material : Brass		Standard Finishes (2-3 Weeks Delivery)				
						
Bright Chrome (Finish ID:2)	Brush Nickel (Finish ID:3)	Unlacquered Polished Brass (Finish ID:7U)	Polished Nickel (Finish ID:8)	Satin Brass (Finish ID:13)		
Base Material : Brass		Custom Finishes (3-4 Weeks Delivery)*				
						
Lacquered Polished Brass (Finish ID:7L)	Hammered over Brush Nickel (Finish ID:12-3)	Hammered over Aged Brass (Finish ID:12-4)	Hammered Over Oil Rubbed Bronze (Finish ID:12-5)	Hammered over Polished Nickel (Finish ID:12-8)	Hammered over Satin Brass (Finish ID:12-13)	Hammered over Rose Gold (Finish ID:12-33)
						
Matte Black (Finish ID:19)	Split White and Nickel (Finish ID:20)	Split Black and Polished Nickel (Finish ID:48)	Split Black and Satin Brass (Finish ID:49)	Split Satin Brass and White (Finish ID:50)	Split Polished Brass And Oil Rubbed Bronze (Finish ID:57)	Split Black And Chrome (Finish ID:59)
						
Split Satin Copper And Oil Rubbed Bronze (Finish ID:60)	Graphite (Finish ID:61)	Split Aged Brass And English Metallic Bronze (Finish ID:75)	Split Polished Nickel And Satin Brass (Finish ID:77)	Split Brush Nickel and Satin Brass (Finish ID:78)	Titanium (Finish ID:79)	Split Oil Rubbed Bronze and Satin Brass (Finish ID:80)
						
Split Graphite and Satin Brass (Finish ID:90)	Split Graphite and Brush Chrome (Finish ID:91)	Ombre (Finish ID:92)	Brush Chrome (Finish ID:95)			

- Custom finishes cannot be returned or refunded. We are unable to accept cancellations for custom finish order unless within 48 hours of the order being placed.
- We have uniform pricing for all non-hammered finishes listed above as long as base material and size is same.
- Contact us for customized finishes, refer pages F1, F2, F3 & F4 for finish glossary.
- Backplate options refer page KBP1-1 to KBP14-1.

Base Material : Brass		Custom Finishes (3-4 Weeks Delivery)*				
 Titanium (Finish ID:79)	 Split Oil Rubbed Bronze And Satin Brass with Satin Brass Back Plate (Finish ID:80A)	 Split Oil Rubbed Bronze And Satin Brass with Oil Rubbed Bronze Back Plate (Finish ID:80B)	 Split Graphite and Satin Brass with Satin Brass Back Plate (Finish ID:90A)	 Split Graphite and Satin Brass with Graphite Back Plate (Finish ID:90B)	 Split Graphite and Brush Chrome with Graphite Back Plate (Finish ID:91A)	 Split Graphite and Brush Chrome with Brush Chrome Back Plate (Finish ID:91B)
 Ombre (Finish ID:92)	 Brush Chrome (Finish ID:95)					

- Custom finishes cannot be returned or refunded. We are unable to accept cancellations for custom finish order unless within 48 hours of the order being placed.
- We have uniform pricing for all non-hammered finishes listed above as long as base material and size is same.
- Contact us for customized finishes, refer pages F1, F2, F3 & F4 for finish glossary.
- Backplate options refer page KBP1-1 to KBP14-1.



Black Epoxy Matt (Finish ID : 19)

BAUHAUS KNOB

“Radically simplified form and function are at the heart of Bauhaus design – reflected well in this cupboard knob.”

	Item Code	Size (mm & Inches)	Material	Size (Inches)				Fig.
				A	B	C	D	
1	KNB.611.19.XX	19mm (0.75")	Brass	0.98	0.75	N/A	N/A	1
2	KNB.611.25.XX	25mm (0.98")	Brass	1.18	0.98	N/A	N/A	1
3	KNB.611.28.XX	28mm (1.1")	Brass	1.38	1.1	N/A	N/A	1
4	KNB.611.32.XX	32mm (1.26")	Brass	1.61	1.26	N/A	N/A	1

“XX” in item code denotes Finish ID.

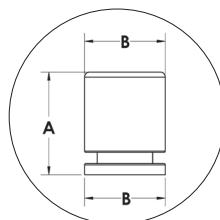

FIG. 1

This product is Supplied with M4x25mm screws.
This product is Supplied with M4x45mm break off screws.

How to Order



Bauhaus Knob Finish Options

Base Material : Brass		Standard Finishes (2-3 Weeks Delivery)				
						
Bright Chrome (Finish ID:2)	Brush Nickel (Finish ID:3)	Aged Brass (Finish ID:4)	Oil Rubbed Bronze (Finish ID:5)	Unlacquered Polished Brass (Finish ID:7U)	Polished Nickel (Finish ID:8)	Satin Brass (Finish ID:13)
Base Material : Brass		Custom Finishes (3-4 Weeks Delivery)*				
						
Lacquered Polished Brass (Finish ID:7L)	Matte Black (Finish ID:19)	White Epoxy (Finish ID:42)	Graphite (Finish ID:61)	Titanium (Finish ID:79)	Ombre (Finish ID:92)	Brush Chrome (Finish ID:95)

- Custom finishes cannot be returned or refunded. We are unable to accept cancellations for custom finish order unless within 48 hours of the order being placed.
- We have uniform pricing for all non-hammered finishes listed above as long as base material and size is same.
- Contact us for customized finishes, refer pages F1, F2, F3 & F4 for finish glossary.
- Backplate options refer page KBP1-1 to KBP14-1.



Unlacquered Polished Brass (Finish ID : 7U)

MARINA KNOB

	Item Code	Size (mm & Inches)	Material	Size (Inches)				Fig.
				A	B	C	D	
1	KNB.612.19.XX	19mm (0.75")	Brass	0.96	0.75	N/A	N/A	1
2	KNB.612.25.XX	25mm (0.98")	Brass	1.18	0.98	N/A	N/A	1
3	KNB.612.28.XX	28mm (1.1")	Brass	1.38	1.1	N/A	N/A	1
4	KNB.612.32.XX	32mm (1.26")	Brass	1.61	1.26	N/A	N/A	1

"XX" in item code denotes Finish ID.

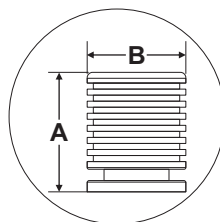

FIG. 1

























This product is Supplied with M4x25mm screws.
This product is Supplied with M4x45mm break off screws.

How to Order

KNB.612.19.7U

KNOB STYLE : MARINA SIZE DIAMETER : 19 MM FINISH ID : 7U

Marina Knob Finish Options

Base Material : Brass		Standard Finishes (2-3 Weeks Delivery)				
						
Bright Chrome (Finish ID:2)	Brush Nickel (Finish ID:3)	Unlacquered Polished Brass (Finish ID:7U)	Polished Nickel (Finish ID:8)	Satin Brass (Finish ID:13)		
Base Material : Brass		Custom Finishes (3-4 Weeks Delivery)*				
						
Lacquered Polished Brass (Finish ID:7L)	Matte Black (Finish ID:19)	White Epoxy (Finish ID:42)	Split Black and Polished Nickel (Finish ID:48)	Split Black and Satin Brass (Finish ID:49)	Split Satin Brass and White (Finish ID:50)	Split Polished Brass And Oil Rubbed Bronze (Finish ID:57)
						
Split Black And Chrome (Finish ID:59)	Split Satin CopperAnd Oil Rubbed Bronze (Finish ID:60)	Graphite (Finish ID:61)	Split Aged Brass And English Metallic Bronze (Finish ID:75)	Split Polished Nickel And Satin Brass (Finish ID:77)	Split Polished Nickel and Satin Brass (Finish ID:78)	Titanium (Finish ID:79)
						
Split Oil Rubbed Bronze and Satin Brass (Finish ID:80)	Split Graphite and Satin Brass (Finish ID:90)	Split Graphite and Brush Chrome (Finish ID:91)	Ombre (Finish ID:92)	Brush Chrome (Finish ID:95)		

- Custom finishes cannot be returned or refunded. We are unable to accept cancellations for custom finish order unless within 48 hours of the order being placed.
- We have uniform pricing for all non-hammered finishes listed above as long as base material and size is same.
- Contact us for customized finishes, refer pages F1, F2, F3 & F4 for finish glossary.
- Backplate options refer page KBP1-1 to KBP14-1.

Marina Knob Split Finish

KNB.612.XX.XX

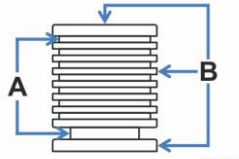
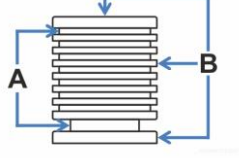
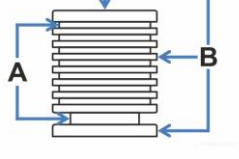
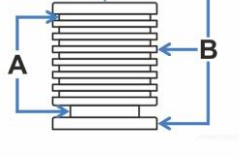
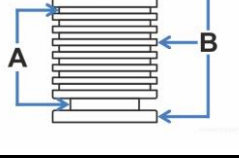
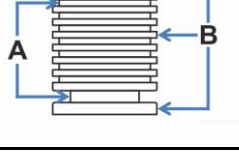
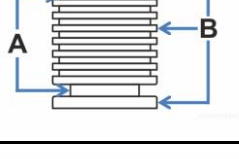
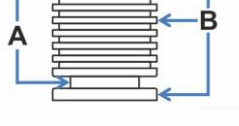
FINISH CODE (XX)	FINISH NAME	LINE DRAWING	A	B
KNB.612.XX.48	Split Black and Polished Nickel		Matte Black	Polished Nickel
KNB.612.XX.49	Split Black and Satin Brass		Matte Black	Satin Brass
KNB.612.XX.50	Split Satin Brass and White		White Epoxy	Satin Brass
KNB.612.XX.57	Split Polished Brass and Oil Rubbed Bronze		Oil Rubbed Bronze	Lacquered Polished Brass
KNB.612.XX.59	Split Black and Chrome		Matte Black	Bright Chrome
KNB.612.XX.60	Split Satin Copper and Oil Rubbed Bronze		Oil Rubbed Bronze	Satin Copper
KNB.612.XX.75	Split Aged Brass and English Metallic Bronze		English Metallic Bronze	Aged Brass
KNB.612.XX.77	Split Polished Nickel and Satin Brass		Polished Nickel	Satin Brass

Marina Knob Split Finish

KNB.612.XX.XX

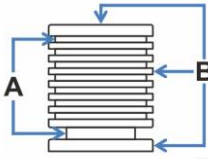
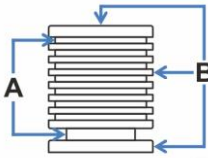
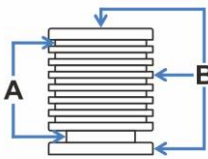
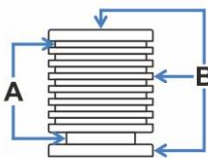
FINISH CODE (XX)	FINISH NAME	LINE DRAWING	A	B
KNB.613.XX.78	Split Brush Nickel and Satin Brass		Brush Nickel	Satin Brass
KNB.612.XX.80	Split Oil Rubbed Bronze and Satin Brass		Oil Rubbed Bronze	Satin Brass
KNB.612.XX.90	Split Graphite and Satin Brass		Graphite	Satin Brass
KNB.612.XX.91	Split Graphite and Brush Chrome		Graphite	Brush Chrome



English Metallic Bronze (Finish ID : 51)

TIFFANY FACET KNOB

“The multi-faceted surface of the Tiffany knob creates a kaleidoscopic effect as light hits it and repeats the reflections.”

	Item Code	Size (mm & Inches)	Material	Size (Inches)				Fig.
				A	B	C	D	
1	KNB.615.28.XX	28mm (1.1")	Brass	1.56	1.1	1.06	N/A	1
2	KNB.615.35.XX	35mm (1.38")	Brass	1.77	1.38	1.36	N/A	1

“XX” in item code denotes Finish ID.

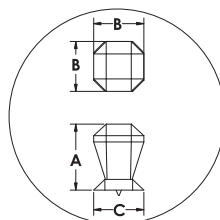

FIG. 1





























This product is Supplied with M4x25mm screws.
This product is Supplied with M4x45mm break off screws.

How to Order

KNB.615.28.51

KNOB STYLE : TIFFANY FACET SIZE DIAMETER : 28 MM FINISH ID : 51

Tiffany Facet Knob Finish Options

Base Material : Brass		Standard Finishes (2-3 Weeks Delivery)				
						
Bright Chrome (Finish ID:2)	Brush Nickel (Finish ID:3)	Aged Brass (Finish ID:4)	Oil Rubbed Bronze (Finish ID:5)	Unlacquered Polished Brass (Finish ID:7U)	Polished Nickel (Finish ID:8)	Satin Brass (Finish ID:13)
Base Material : Brass		Custom Finishes (3-4 Weeks Delivery)*				
						
Lacquered Polished Brass (Finish ID:7L)	Antique Copper (Finish ID:15)	Matte Black (Finish ID:19)	Rose Gold (Finish ID:33)	Split Black and Polished Nickel (Finish ID:48)	Split Black and Satin Brass (Finish ID:49)	Split Satin Brass and White (Finish ID:50)
						
English Metallic Bronze (Finish ID:51)	Split Polished Brass And Oil Rubbed Bronze (Finish ID:57)	Split Black And Chrome (Finish ID:59)	Split Satin Copper And Oil Rubbed Bronze (Finish ID:60)	Graphite (Finish ID:61)	Split Aged Brass And English Metallic Bronze (Finish ID:75)	Split Polished Nickel And Satin Brass (Finish ID:77)
						
Split Brush Nickel and Satin Brass (Finish ID:78)	Titanium (Finish ID:79)	Split Oil Rubbed Bronze and Satin Brass (Finish ID:80)	Split Graphite and Satin Brass (Finish ID:90)	Split Graphite and Brush Chrome (Finish ID:91)	Ombre (Finish ID:92)	Brush Chrome (Finish ID:95)

- Custom finishes cannot be returned or refunded. We are unable to accept cancellations for custom finish order unless within 48 hours of the order being placed.
- We have uniform pricing for all non-hammered finishes listed above as long as base material and size is same.
- Contact us for customized finishes, refer pages F1, F2, F3 & F4 for finish glossary.
- Backplate options refer page KBP1-1 to KBP14-1.



Split Black and Brush Brass (Finish ID : 49)

MONACO KNOB

“The concentric rings are reminiscent of a stack of chips in the world-famous Place des Casino, synonymous with the history of Monaco.”

	Item Code	Size (mm & Inches)	Material	Size (Inches)				Fig.
				A	B	C	D	
1	KNB.613.19.XX	19mm (0.75")	Brass	0.98	0.75	N/A	N/A	1
2	KNB.613.25.XX	25mm (0.98")	Brass	1.18	0.98	N/A	N/A	1
3	KNB.613.28.XX	28mm (1.1")	Brass	1.38	1.1	N/A	N/A	1
4	KNB.613.32.XX	32mm (1.26")	Brass	1.61	1.26	N/A	N/A	1

“XX” in item code denotes Finish ID.

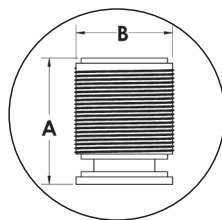

FIG. 1

































This product is Supplied with M4x25mm screws.
This product is Supplied with M4x45mm break off screws.

How to Order

KNB.613.19.49

KNOB STYLE : MONACO SIZE DIAMETER : 19 MM FINISH ID : 49

Monaco Knob Finish Options

Base Material : Brass		Standard Finishes (2-3 Weeks Delivery)				
						
Bright Chrome (Finish ID:2)	Brush Nickel (Finish ID:3)	Aged Brass (Finish ID:4)	Oil Rubbed Bronze (Finish ID:5)	Unlacquered Polished Brass (Finish ID:7U)	Polished Nickel (Finish ID:8)	Satin Brass (Finish ID:13)
Base Material : Brass		Custom Finishes (3-4 Weeks Delivery)*				
						
Lacquered Polished Brass (Finish ID:7L)	Antique Copper (Finish ID:15)	Matte Black (Finish ID:19)	Split White and Nickel (Finish ID:20)	Rose Gold (Finish ID:33)	White Epoxy (Finish ID:42)	Split Black and Polished Nickel (Finish ID:48)
						
Split Black and Satin Brass (Finish ID:49)	Split Satin Brass and White (Finish ID:50)	English Metallic Bronze (Finish ID:51)	Split Polished Brass And Oil Rubbed Bronze (Finish ID:57)	Satin Copper (Finish ID:58)	Split Black And Chrome (Finish ID:59)	Split Satin Copper And Oil Rubbed Bronze (Finish ID:60)
						
Graphite (Finish ID:61)	Split Aged Brass And English Metallic Bronze (Finish ID:75)	Split Polished Nickel And Satin Brass (Finish ID:77)	Split Brush Nickel and Satin Brass (Finish ID:78)	Titanium (Finish ID:79)	Split Oil Rubbed Bronze and Satin Brass (Finish ID:80)	Split Graphite and Satin Brass (Finish ID:90)
						
Split Graphite and Brush Chrome (Finish ID:91)	Ombre (Finish ID:92)	Split Graphite and Aged Brass (Finish ID:93)	Brush Chrome (Finish ID:95)			

- Custom finishes cannot be returned or refunded. We are unable to accept cancellations for custom finish order unless within 48 hours of the order being placed.
- We have uniform pricing for all non-hammered finishes listed above as long as base material and size is same.
- Contact us for customized finishes, refer pages F1, F2, F3 & F4 for finish glossary.
- Backplate options refer page KBP1-1 to KBP14-1.

Monaco Knob Split Finish

KNB.613.XX.XX

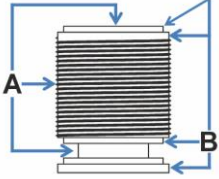
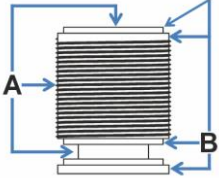
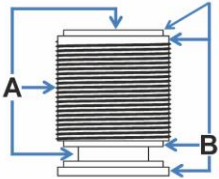
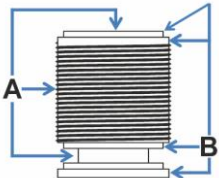
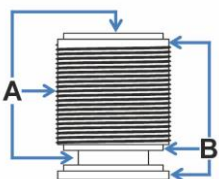
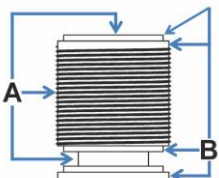
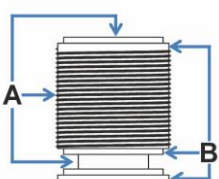
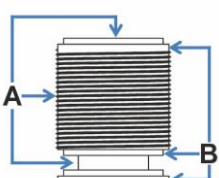
FINISH CODE (XX)	FINISH NAME	LINE DRAWING	A	B
KNB.613.XX.20	Split White and Polished Nickel		White Epoxy	Polished Nickel
KNB.613.XX.48	Split Black and Polished Nickel		Matte Black	Polished Nickel
KNB.613.XX.49	Split Black and Satin Brass		Matte Black	Satin Brass
KNB.613.XX.50	Split Satin Brass and White		White Epoxy	Satin Brass
KNB.613.XX.57	Split Polished Brass and Oil Rubbed Bronze		Oil Rubbed Bronze	Lacquered Polished Brass
KNB.613.XX.59	Split Black and Chrome		Matte Black	Bright Chrome
KNB.613.XX.60	Split Satin Copper and Oil Rubbed Bronze		Oil Rubbed Bronze	Satin Copper
KNB.613.XX.75	Split Aged Brass and English Metallic Bronze		English Metallic Bronze	Aged Brass

Monaco Knob Split Finish

KNB.613.XX.XX

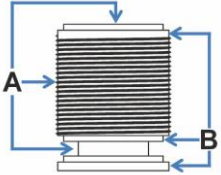
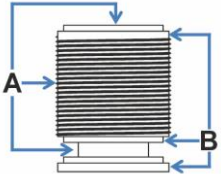
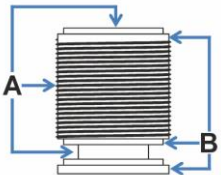
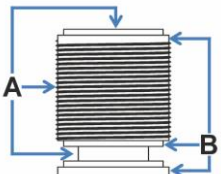
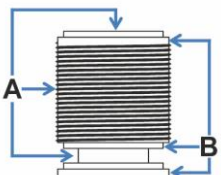
FINISH CODE (XX)	FINISH NAME	LINE DRAWING	A	B
KNB.613.XX.77	Split Polished Nickel and Satin Brass		Satin Brass	Polished Nickel
KNB.613.XX.78	Split Brush Nickel and Satin Brass		Brush Nickel	Satin Brass
KNB.613.XX.80	Split Oil Rubbed Bronze and Satin Brass		Oil Rubbed Bronze	Satin Brass
KNB.613.XX.90	Split Graphite and Satin Brass		Graphite	Satin Brass
KNB.613.XX.91	Split Graphite and Brush Chrome		Graphite	Brush Chrome



Satin Copper (Finish ID : 58)

JEFFREY KNOB

	Item Code	Size (mm & Inches)	Material	Size (Inches)				Fig.
				A	B	C	D	
1	KNB.617.32.XX	32mm (1.26")	Brass	1.46	1.26	1.26	N/A	1
2	KNB.617.38.XX	38mm (1.5")	Brass	1.38	1.5	1.26	N/A	1
3	KNB.617.32.XX	32mm (1.26")	Bronze	1.46	1.26	1.26	N/A	1
4	KNB.617.38.XX	38mm (1.5")	Bronze	1.4	1.48	1.24	N/A	1

"XX" in item code denotes Finish ID.

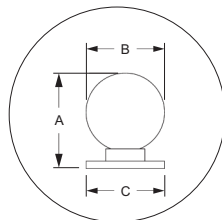

FIG. 1



















This product is Supplied with M4x30mm screws.
This product is Supplied with M4x45mm break off screws.

How to Order

KNB.617.32.58

KNOB STYLE : JEFFREY SIZE DIAMETER : 32 MM FINISH ID : 58

Jeffrey Knob Finish Options

Base Material : Brass		Standard Finishes (2-3 Weeks Delivery)				
						
Bright Chrome (Finish ID:2)	Brush Nickel (Finish ID:3)	Aged Brass (Finish ID:4)	Oil Rubbed Bronze (Finish ID:5)	Unlacquered Polished Brass (Finish ID:7U)	Polished Nickel (Finish ID:8)	Satin Brass (Finish ID:13)
Base Material : Brass		Custom Finishes (3-4 Weeks Delivery)*				
						
Lacquered Polished Brass (Finish ID:7L)	Antique Copper (Finish ID:15)	Matte Black (Finish ID:19)	Rose Gold (Finish ID:33)	Satin Copper (Finish ID:58)	Graphite (Finish ID:61)	Ombre (Finish ID:92)
						
Brush Chrome (Finish ID:95)						
Base Material : Bronze		Custom Finishes (3-4 Weeks Delivery)*				
						
Silicon Bronze Light (Finish ID:53)	Silicon Bronze Dark (Finish ID:53D)	White Bronze (Finish ID:54)				

- Custom finishes cannot be returned or refunded. We are unable to accept cancellations for custom finish order unless within 48 hours of the order being placed.
- We have uniform pricing for all non-hammered finishes listed above as long as base material and size is same.
- Contact us for customized finishes, refer pages F1, F2, F3 & F4 for finish glossary.
- Backplate options refer page KBP1-1 to KBP14-1.



Aged Brass (Finish ID : 4)

HERITAGE KNOB

“Stepped concentric circles of the end posts transition onto the curvilinear bar, classic clean lines can be further enhanced with tactile leather finished with exquisitely detailed saddle stitch.”

	Item Code	Size (mm & Inches)	Material	Size (Inches)				Fig.
				A	B	C	D	
1	KNB.626.32.XX	32mm (1.26")	Brass	1.14	1.26	N/A	N/A	1
2	KNB.626.38.XX	38mm (1.5")	Brass	1.28	1.5	N/A	N/A	1
3	KNB.626.32.XX	32mm (1.26")	Cast Iron	1.14	1.26	N/A	N/A	1
4	KNB.626.38.XX	38mm (1.5")	Cast Iron	1.28	1.5	N/A	N/A	1

“XX” in item code denotes Finish ID.

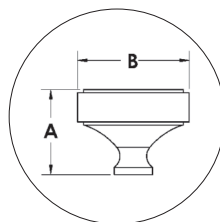

FIG. 1

This product is Supplied with M4x25mm screws.
This product is Supplied with M4x45mm break off screws.

How to Order

KNB.626.32.4

KNOB STYLE : HERITAGE SIZE DIAMETER : 32 MM FINISH ID : 4

Heritage Knob Finish Options

Base Material : Cast Iron		Custom Finishes (3-4 Weeks Delivery)*			
 <p>Pewter (Finish ID:1)</p>					
Base Material : Brass		Standard Finishes (2-3 Weeks Delivery)			
 <p>Brush Nickel (Finish ID:3)</p>  <p>Aged Brass (Finish ID:4)</p>  <p>Oil Rubbed Bronze (Finish ID:5)</p>  <p>Unlacquered Polished Brass (Finish ID:7U)</p>  <p>Polished Nickel (Finish ID:8)</p>  <p>Satin Brass (Finish ID:13)</p>					
Base Material : Brass		Custom Finishes (3-4 Weeks Delivery)*			
 <p>Lacquered Polished Brass (Finish ID:7L)</p>  <p>Matte Black (Finish ID:19)</p>  <p>Split Black and Satin Brass (Finish ID:49)</p>					
Base Material : Bronze		Custom Finishes (3-4 Weeks Delivery)*			
 <p>Silicon Bronze Light (Finish ID:53)</p>  <p>Silicon Bronze Dark (Finish ID:53D)</p>					

- Custom finishes cannot be returned or refunded. We are unable to accept cancellations for custom finish order unless within 48 hours of the order being placed.
- We have uniform pricing for all non-hammered finishes listed above as long as base material and size is same.
- Contact us for customized finishes, refer pages F1, F2, F3 & F4 for finish glossary.
- Backplate options refer page KBP1-1 to KBP14-1.

Heritage Knob Split Finish

KNB.626.XX.XX

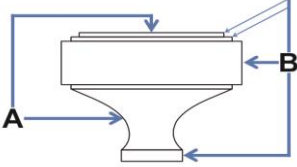
FINISH CODE (XX)	FINISH NAME	LINE DRAWING	A	B
KNB.626.XX.49	Split Black and Satin Brass	 <p>The line drawing shows a knob with a split finish. Area A is the main body of the knob, and Area B is the top rim. Arrows point from the labels 'A' and 'B' to their respective areas on the drawing.</p>	Matte Black	Satin Brass



Unlacquered Polished Brass (Finish ID : 7U)

QUEEN'S KNOB

	Item Code	Size (mm & Inches)	Material	Size (Inches)				Fig.
				A	B	C	D	
1	KNB.633.25.XX	25mm (0.98")	Brass	0.87	0.87	0.55	1.26	1
2	KNB.633.32.XX	32mm (1.26")	Brass	1.1	1	0.63	1.5	1
3	KNB.633.38.XX	38mm (1.5")	Brass	1.31	1.1	0.75	1.57	1

"XX" in item code denotes Finish ID.

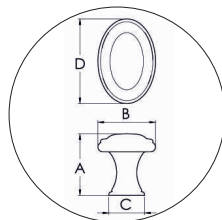

FIG. 1

This product is Supplied with M4x25mm screws.
This product is Supplied with M4x45mm break off screws.

How to Order



Queen's Knob Finish Options

Base Material : Brass		Standard Finishes (2-3 Weeks Delivery)				
						
Bright Chrome (Finish ID:2)	Brush Nickel (Finish ID:3)	Aged Brass (Finish ID:4)	Oil Rubbed Bronze (Finish ID:5)	Unlacquered Polished Brass (Finish ID:7U)	Polished Nickel (Finish ID:8)	Satin Brass (Finish ID:13)
Base Material : Brass		Custom Finishes (3-4 Weeks Delivery)*				
						
Lacquered Polished Brass (Finish ID:7L)	Ombre (Finish ID:92)	Brush Chrome (Finish ID:95)				

- Custom finishes cannot be returned or refunded. We are unable to accept cancellations for custom finish order unless within 48 hours of the order being placed.
- We have uniform pricing for all non-hammered finishes listed above as long as base material and size is same.
- Contact us for customized finishes, refer pages F1, F2, F3 & F4 for finish glossary.
- Backplate options refer page KBP1-1 to KBP14-1.



Polished Nickel (Finish ID : 8)

HEXAD KNOB

“Hexad again seeks inspiration from nature, bees form the bedrock of all civilisation. They choose the six sided hexagon as the most effective shape to store honey in their hives as they fit together perfectly.”

Item Code	Size (mm & Inches)	Material	Size (Inches)				Fig.	
			A	B	C	D		
1	KNB.643.15.XX	15mm (0.59")	Brass	0.83	0.47	0.56	N/A	1
2	KNB.643.20.XX	20mm (0.79")	Brass	1.2	0.59	0.73	N/A	1
3	KNB.643.25.XX	25mm (0.98")	Brass	1.2	0.87	1	N/A	1
4	KNB.643.30.XX	30mm (1.18")	Brass	1.39	0.98	1.1	N/A	1
5	KNB.643.15.XX	15mm (0.59")	Bronze	1.19	0.59	0.75	N/A	1
6	KNB.643.20.XX	20mm (0.79")	Bronze	1.18	0.85	0.96	N/A	1
7	KNB.643.25.XX	25mm (0.98")	Bronze	1.19	0.98	0.85	N/A	1
8	KNB.643.30.XX	30mm (1.18")	Bronze	1.36	0.94	1.1	N/A	1

“XX” in item code denotes Finish ID.

This product is Supplied with M4x25mm screws.
This product is Supplied with M4x45mm break off screws.

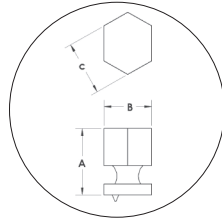

FIG. 1

How to Order

KNB.643.15.8

KNOB STYLE : HEXAD SIZE DIAMETER : 15 MM FINISH ID : 8

Hexad Knob Finish Options

Base Material : Brass		Standard Finishes (2-3 Weeks Delivery)				
						
Bright Chrome (Finish ID:2)	Brush Nickel (Finish ID:3)	Aged Brass (Finish ID:4)	Oil Rubbed Bronze (Finish ID:5)	Unlacquered Polished Brass (Finish ID:7U)	Polished Nickel (Finish ID:8)	Satin Brass (Finish ID:13)
Base Material : Brass		Custom Finishes (3-4 Weeks Delivery)*				
						
Lacquered Polished Brass (Finish ID:7L)	Matte Black (Finish ID:19)	Graphite (Finish ID:61)	Titanium (Finish ID:79)	Ombre (Finish ID:92)	Brush Chrome (Finish ID:95)	
Base Material : Bronze		Custom Finishes (3-4 Weeks Delivery)*				
						
Silicon Bronze Light (Finish ID:53)	Silicon Bronze Dark (Finish ID:53D)	White Bronze (Finish ID:54)				

- Custom finishes cannot be returned or refunded. We are unable to accept cancellations for custom finish order unless within 48 hours of the order being placed.
- We have uniform pricing for all non-hammered finishes listed above as long as base material and size is same.
- Contact us for customized finishes, refer pages F1, F2, F3 & F4 for finish glossary.
- Backplate options refer page KBP1-1 to KBP14-1.



Brush Nickel (Finish ID : 3)

CHELSEA KNOB

	Item Code	Size (mm & Inches)	Material	Size (Inches)				Fig.
				A	B	C	D	
1	KNB.644.25.XX	25mm (0.98")	Brass	0.89	0.98	1.77	N/A	1
2	KNB.644.32.XX	32mm (1.26")	Brass	0.91	1.26	2.17	N/A	1
3	KNB.644.38.XX	38mm (1.5")	Brass	1.02	1.5	2.99	N/A	1

"XX" in item code denotes Finish ID.

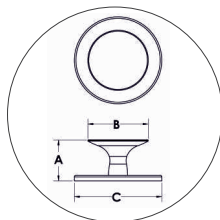

FIG. 1





























This product is Supplied with M4x30mm screws.
This product is Supplied with M4x45mm break off screws.

How to Order

KNB.644.25.3

KNOB STYLE : CHELSEA SIZE DIAMETER : 25 MM FINISH ID : 3

Chelsea Knob Finish Options

Base Material : Brass			Standard Finishes (2-3 Weeks Delivery)			
						
Bright Chrome (Finish ID:2)	Brush Nickel (Finish ID:3)	Aged Brass (Finish ID:4)	Oil Rubbed Bronze (Finish ID:5)	Unlacquered Polished Brass (Finish ID:7U)	Polished Nickel (Finish ID:8)	Satin Brass (Finish ID:13)
Base Material : Brass			Custom Finishes (3-4 Weeks Delivery)*			
						
Lacquered Polished Brass (Finish ID:7L)	Matte Black (Finish ID:19)	Split Black and Polished Nickel with Polished Nickel Back Plate (Finish ID:48A)	Split Black and Polished Nickel with Black Back Plate (Finish ID:48B)	Split Black and Satin Brass with Satin Brass Back Plate (Finish ID:49A)	Split Black and Satin Brass with Black Back Plate (Finish ID:49B)	Split Satin Brass and White with Satin Brass Back Plate (Finish ID:50A)
						
Split Satin Brass and White with White Back Plate (Finish ID:50B)	English Metallic Bronze (Finish ID:51)	Split Polished Brass and Oil Rubbed Bronze with Polished Brass Back Plate (Finish ID:57A)	Split Polished Brass and Oil Rubbed Bronze with Oil Rubbed Bronze Back Plate (Finish ID:57B)	Satin Copper (Finish ID:58)	Split Black and Chrome with Chrome Back Plate (Finish ID:59A)	Split Black and Chrome with Black Back Plate (Finish ID:59B)
						
Split Satin Copper and Oil Rubbed Bronze with Satin Copper Back Plate (Finish ID:60A)	Split Satin Copper and Oil Rubbed Bronze with Oil Rubbed Bronze Back Plate (Finish ID:60B)	Graphite (Finish ID:61)	Split Aged Brass and English Metallic Bronze with Aged Brass Back Plate (Finish ID:75A)	Split Aged Brass and English Metallic Bronze with English Metallic Bronze Back Plate (Finish ID:75B)	Split Polished Nickel and Satin Brass with Satin Brass Back Plate (Finish ID:77A)	Split Polished Nickel and Satin Brass with Polished Nickel Back Plate (Finish ID:77B)



- Custom finishes cannot be returned or refunded. We are unable to accept cancellations for custom finish order unless within 48 hours of the order being placed.
- We have uniform pricing for all non-hammered finishes listed above as long as base material and size is same.
- Contact us for customized finishes, refer pages F1, F2, F3 & F4 for finish glossary.
- Backplate options refer page KBP1-1 to KBP14-1.

Base Material : Brass		Custom Finishes (3-4 Weeks Delivery)*				
 Split Brush Nickel and Satin Brass with Satin Brass Back Plate (Finish ID:78A)	 Split Brush Nickel and Satin Brass with Brush Nickel Back Plate (Finish ID:78B)	 Titanium (Finish ID:79)	 Split Oil Rubbed Bronze And Satin Brass with Satin Brass Back Plate (Finish ID:80A)	 Split Oil Rubbed Bronze And Satin Brass with Oil Rubbed Bronze Back Plate (Finish ID:80B)	 Split Graphite and Satin Brass with Satin Brass Back Plate (Finish ID:90A)	 Split Graphite and Satin Brass with Graphite Back Plate (Finish ID:90B)
 Split Graphite and Brush Chrome with Graphite Back Plate (Finish ID:91A)	 Split Graphite and Brush Chrome with Brush Chrome Back Plate (Finish ID:91B)	 Ombre (Finish ID:92)	 Brush Chrome (Finish ID:95)			

- Custom finishes cannot be returned or refunded. We are unable to accept cancellations for custom finish order unless within 48 hours of the order being placed.
- We have uniform pricing for all non-hammered finishes listed above as long as base material and size is same.
- Contact us for customized finishes, refer pages F1, F2, F3 & F4 for finish glossary.
- Backplate options refer page KBP1-1 to KBP14-1.

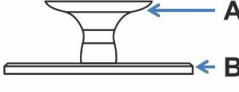
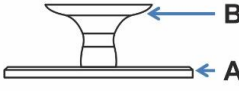
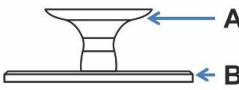
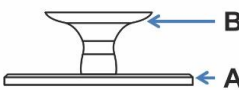
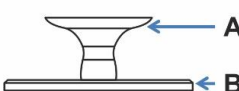
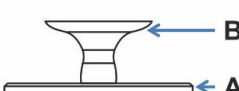
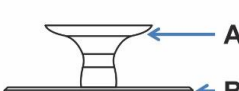

Chelsea Knob Split Finish

KNB.644.XX.XX

FINISH CODE (XX)	FINISH NAME	LINE DRAWING	A	B
KNB.644.XX.48A	Split Black and Nickel with Polished Nickel Back Plate		Matte Black	Polished Nickel
KNB.644.XX.48B	Split Black and Nickel with Black Back Plate		Matte Black	Polished Nickel
KNB.644.XX.49A	Split Black and Satin Brass with Satin Brass Back Plate		Matte Black	Satin Brass
KNB.644.XX.49B	Split Black and Satin Brass with Black Back Plate		Matte Black	Satin Brass
KNB.644.XX.50A	Split Satin Brass and White with Satin Brass Back Plate		White Epoxy	Satin Brass
KNB.644.XX.50B	Split Satin Brass and White with White Back Plate		White Epoxy	Satin Brass
KNB.644.XX.57A	Split Lacquered Polished Brass and Oil Rubbed Bronze with Lacquered Polished Brass Back Plate		Oil Rubbed Bronze	Lacquered Polished Brass
KNB.644.XX.57B	Split Lacquered Polished Brass and Oil Rubbed Bronze with Oil Rubbed Bronze Back Plate		Oil Rubbed Bronze	Lacquered Polished Brass

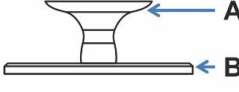
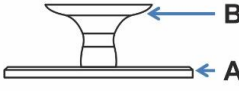
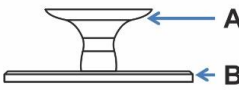
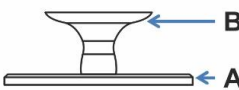
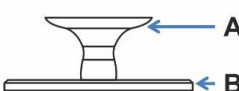
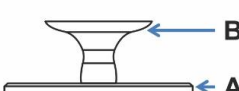
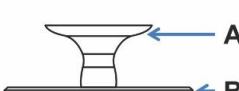

Chelsea Knob Split Finish

KNB.644.XX.XX

FINISH CODE (XX)	FINISH NAME	LINE DRAWING	A	B
KNB.644.XX.59A	Split Black and chrome with chrome back plate		Matte Black	Bright Chrome
KNB.644.XX.59B	Split Black and chrome / Black back plate		Matte Black	Bright Chrome
KNB.644.XX.60A	Split Satin Copper and Oil Rubbed Bronze with Satin Copper Back Plate		Oil Rubbed Bronze	Satin Copper
KNB.644.XX.60B	Split Satin Copper and Oil Rubbed Bronze with Oil Rubbed Bronze Back Plate		Oil Rubbed Bronze	Satin Copper
KNB.644.XX.75A	Split Aged Brass and English Metallic Bronze with Aged Brass Back Plate		English Metallic Bronze	Aged Brass
KNB.644.XX.75B	Split Aged Brass and English Metallic Bronze with English Metallic Bronze Back Plate		English Metallic Bronze	Aged Brass
KNB.644.XX.77A	Split Polished Nickel and Satin Brass with Satin Brass Back Plate		Polished Nickel	Satin Brass
KNB.644.XX.77B	Split Polished Nickel and Satin Brass with Polished Nickel Back Plate		Polished Nickel	Satin Brass

Chelsea Knob Split Finish

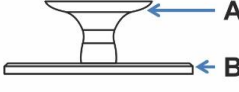
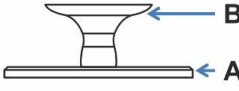
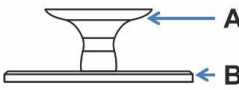
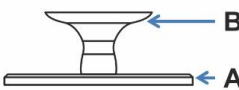
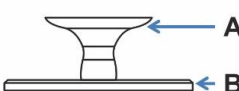
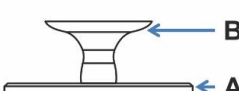
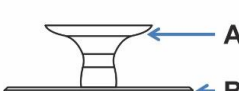
KNB.644.XX.XX

FINISH CODE (XX)	FINISH NAME	LINE DRAWING	A	B
KNB.644.XX.78A	Split Brush Nickel and Satin Brass with Satin Brass Back Plate		Brush Nickel	Satin Brass
KNB.644.XX.78B	Split Brush Nickel and Satin Brass with Brush Nickel Back Plate		Brush Nickel	Satin Brass
KNB.644.XX.80A	Split Oil Rubbed Bronze and Satin Brass with Satin Brass Back Plate		Oil Rubbed Bronze	Satin Brass
KNB.644.XX.80B	Split Oil Rubbed Bronze and Satin Brass with Oil Rubbed Bronze Back Plate		Oil Rubbed Bronze	Satin Brass
KNB.644.XX.90A	Split Graphite and Satin Brass with Satin Brass Back Plate		Graphite	Satin Brass
KNB.644.XX.90B	Split Graphite and Satin Brass with Graphite Back Plate		Graphite	Satin Brass
KNB.644.XX.91A	Split Graphite and Brush Chrome with Brush Chrome Back Plate		Graphite	Brush Chrome
KNB.644.XX.91B	Split Graphite and Brush Chrome with Graphite Back Plate		Graphite	Brush Chrome



Graphite (Finish ID : 61)

RIVOLI KNOB

	Item Code	Size (mm & Inches)	Material	Size (Inches)				Fig.
				A	B	C	D	
1	KNB.647.32.XX	32mm (1.26")	Brass	1.54	1.4	1.26	N/A	1
2	KNB.647.38.XX	38mm (1.5")	Brass	1.69	1.5	1.26	N/A	1

"XX" in item code denotes Finish ID.

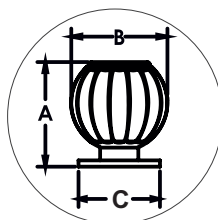

FIG. 1

This product is Supplied with M4x30mm screws.
This product is Supplied with M4x45mm break off screws.

How to Order

KNB.647.32.61

KNOB STYLE : RIVOLI SIZE DIAMETER : 32 MM FINISH ID : 61

Rivoli Knob Finish Options

Base Material : Brass			Standard Finishes (2-3 Weeks Delivery)			
						
Bright Chrome (Finish ID:2)	Brush Nickel (Finish ID:3)	Aged Brass (Finish ID:4)	Oil Rubbed Bronze (Finish ID:5)	Unlacquered Polished Brass (Finish ID:7U)	Polished Nickel (Finish ID:8)	Satin Brass (Finish ID:13)
Base Material : Brass			Custom Finishes (3-4 Weeks Delivery)*			
						
Lacquered Polished Brass (Finish ID:7L)	Antique Copper (Finish ID:15)	Matte Black (Finish ID:19)	Graphite (Finish ID:61)	Titanium (Finish ID:79)	Ombre (Finish ID:92)	Brush Chrome (Finish ID:95)

- Custom finishes cannot be returned or refunded. We are unable to accept cancellations for custom finish order unless within 48 hours of the order being placed.
- We have uniform pricing for all non-hammered finishes listed above as long as base material and size is same.
- Contact us for customized finishes, refer pages F1, F2, F3 & F4 for finish glossary.
- Backplate options refer page KBP1-1 to KBP14-1.



Polished Nickel (Finish ID : 8)

CLIFF KNOB

	Item Code	Size (mm & Inches)	Material	Size (Inches)				Fig.
				A	B	C	D	
1	KNB.650.20.XX	20mm (0.79")	Brass	0.83	0.79	0.67	N/A	1
2	KNB.650.32.XX	32mm (1.26")	Brass	1.02	1.3	1.02	N/A	1
3	KNB.650.38.XX	38mm (1.5")	Brass	1.18	1.5	1.18	N/A	1
4	KNB.650.20.XX	20mm (0.79")	Bronze	0.83	0.79	0.67	N/A	1
5	KNB.650.32.XX	32mm (1.26")	Bronze	1.02	1.26	1.02	N/A	1
6	KNB.650.38.XX	38mm (1.5")	Bronze	1.18	1.5	1.18	N/A	1

"XX" in item code denotes Finish ID.

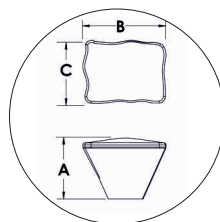



















FIG. 1

This product is Supplied with M4x25mm screws.
This product is Supplied with M4x45mm break off screws.

How to Order



Cliff Knob Finish Options

Base Material : Brass		Standard Finishes (2-3 Weeks Delivery)				
						
Bright Chrome (Finish ID:2)	Brush Nickel (Finish ID:3)	Aged Brass (Finish ID:4)	Oil Rubbed Bronze (Finish ID:5)	Unlacquered Polished Brass (Finish ID:7U)	Polished Nickel (Finish ID:8)	Satin Brass (Finish ID:13)
Base Material : Brass		Custom Finishes (3-4 Weeks Delivery)*				
						
Lacquered Polished Brass (Finish ID:7L)	Antique Copper (Finish ID:15)	Matte Black (Finish ID:19)	White Epoxy (Finish ID:42)	English Metallic Bronze (Finish ID:51)	Graphite (Finish ID:61)	Ombre (Finish ID:92)
						
Brush Chrome (Finish ID:95)						
Base Material : Bronze		Custom Finishes (3-4 Weeks Delivery)*				
						
Silicon Bronze Light (Finish ID:53)	Silicon Bronze Dark (Finish ID:53D)	White Bronze (Finish ID:54)				

- Custom finishes cannot be returned or refunded. We are unable to accept cancellations for custom finish order unless within 48 hours of the order being placed.
- We have uniform pricing for all non-hammered finishes listed above as long as base material and size is same.
- Contact us for customized finishes, refer pages F1, F2, F3 & F4 for finish glossary.
- Backplate options refer page KBP1-1 to KBP14-1.

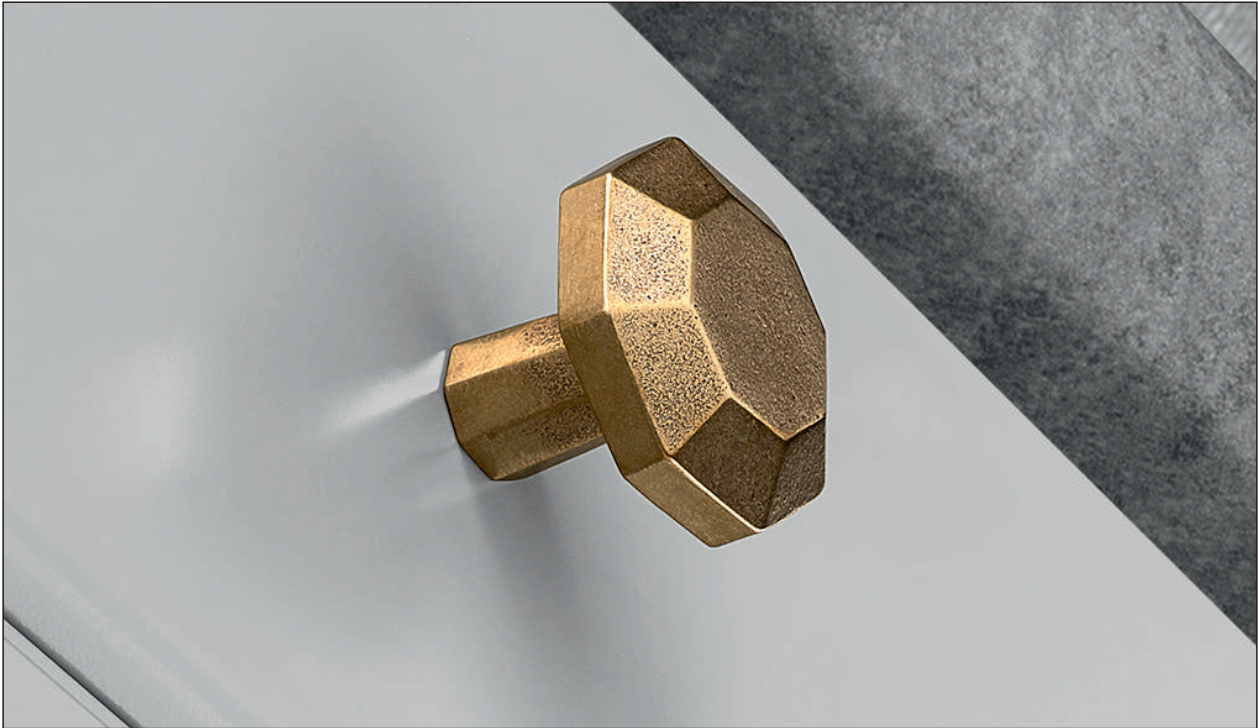

Silicon Bronze Light (Finish ID : 53)

BIJOU KNOB

	Item Code	Size (mm & Inches)	Material	Size (Inches)				Fig.
				A	B	C	D	
1	KNB.651.32.XX	32mm (1.26")	Brass	1	1.26	N/A	N/A	1
2	KNB.651.38.XX	38mm (1.5")	Brass	1.18	1.5	N/A	N/A	1
3	KNB.651.32.XX	32mm (1.26")	Bronze	1	1.26	N/A	N/A	1
4	KNB.651.38.XX	38mm (1.5")	Bronze	1.16	1.5	N/A	N/A	1

"XX" in item code denotes Finish ID.

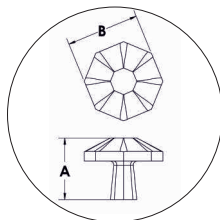

FIG. 1

This product is Supplied with M4x25mm screws.
This product is Supplied with M4x45mm break off screws.

How to Order

KNB.651.32.53

KNOB STYLE : BIJOU SIZE DIAMETER : 32 MM FINISH ID : 53

Bijou Knob Finish Options

Base Material : Brass		Standard Finishes (2-3 Weeks Delivery)				
						
Bright Chrome (Finish ID:2)		Aged Brass (Finish ID:4)	Oil Rubbed Bronze (Finish ID:5)	Unlacquered Polished Brass (Finish ID:7U)	Polished Nickel (Finish ID:8)	Satin Brass (Finish ID:13)
Base Material : Brass		Custom Finishes (3-4 Weeks Delivery)*				
						
Lacquered Polished Brass (Finish ID:7L)	Matte Black (Finish ID:19)	English Metallic Bronze (Finish ID:51)	Graphite (Finish ID:61)	Titanium (Finish ID:79)	Ombre (Finish ID:92)	Brush Chrome (Finish ID:95)
Base Material : Bronze		Custom Finishes (3-4 Weeks Delivery)*				
						
Silicon Bronze Light (Finish ID:53)	Silicon Bronze Dark (Finish ID:53D)	White Bronze (Finish ID:54)				

- Custom finishes cannot be returned or refunded. We are unable to accept cancellations for custom finish order unless within 48 hours of the order being placed.
- We have uniform pricing for all non-hammered finishes listed above as long as base material and size is same.
- Contact us for customized finishes, refer pages F1, F2, F3 & F4 for finish glossary.
- Backplate options refer page KBP1-1 to KBP14-1.



Satin Brass (Finish ID : 13)

BURBRIDGE KNOB

“Our Burbridge handle is an uplifting Art Deco design with beautifully crafted tapered facets that reflect the surroundings.”

	Item Code	Size (mm & Inches)	Material	Size (Inches)				Fig.
				A	B	C	D	
1	KNB.652.32.XX	32mm (1.26")	Brass	1.36	1.24	0.75	N/A	1
2	KNB.652.38.XX	38mm (1.5")	Brass	1.4	1.5	0.98	N/A	1
3	KNB.652.32.XX	32mm (1.26")	Bronze	1.32	1.24	0.75	N/A	1
4	KNB.652.38.XX	38mm (1.5")	Bronze	1.36	1.48	0.98	N/A	1
5	KNB.652.32.XX	32mm (1.26")	Pewter Effect / Cast Iron	1.32	1.24	0.75	N/A	1
6	KNB.652.38.XX	38mm (1.5")	Pewter Effect / Cast Iron	1.36	1.48	0.98	N/A	1

“XX” in item code denotes Finish ID.

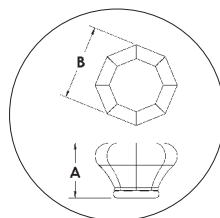

FIG. 1

This product is Supplied with M4x30mm screws.
This product is Supplied with M4x45mm break off screws.

How to Order

KNB.652.32.13

KNOB STYLE : BURBRIDGE | SIZE DIAMETER : 32 MM | FINISH ID : 13

Burbridge Knob Finish Options

Base Material : Cast Iron		Custom Finishes (3-4 Weeks Delivery)*				
 <p>Pewter (Finish ID:1)</p>						
Base Material : Brass		Standard Finishes (2-3 Weeks Delivery)				
 <p>Bright Chrome (Finish ID:2)</p>  <p>Brush Nickel (Finish ID:3)</p>  <p>Aged Brass (Finish ID:4)</p>  <p>Oil Rubbed Bronze (Finish ID:5)</p>  <p>Untacquered Polished Brass (Finish ID:7U)</p>  <p>Polished Nickel (Finish ID:8)</p>  <p>Satin Brass (Finish ID:13)</p>						
Base Material : Brass		Custom Finishes (3-4 Weeks Delivery)*				
 <p>Lacquered Polished Brass (Finish ID:7L)</p>  <p>Antique Copper (Finish ID:15)</p>  <p>English Metallic Bronze (Finish ID:51)</p>  <p>Graphite (Finish ID:61)</p>  <p>Ombre (Finish ID:92)</p>  <p>Brush Chrome (Finish ID:95)</p>						
Base Material : Bronze		Custom Finishes (3-4 Weeks Delivery)*				
 <p>Silicon Bronze Light (Finish ID:53)</p>  <p>Silicon Bronze Dark (Finish ID:53D)</p>  <p>White Bronze (Finish ID:54)</p>						

- Custom finishes cannot be returned or refunded. We are unable to accept cancellations for custom finish order unless within 48 hours of the order being placed.
- We have uniform pricing for all non-hammered finishes listed above as long as base material and size is same.
- Contact us for customized finishes, refer pages F1, F2, F3 & F4 for finish glossary.
- Backplate options refer page KBP1-1 to KBP14-1.



Oil Rubbed Bronze (Finish ID : 5)

ANVIL KNOB

“Form and function complemented by a clean and defined stepped edge detail well reflect different colour accents.”

	Item Code	Size (mm & Inches)	Material	Size (Inches)				Fig.
				A	B	C	D	
1	KNB.653.25.XX	25mm (0.98")	Brass	0.83	0.98	0.65	N/A	1
2	KNB.653.32.XX	32mm (1.26")	Brass	0.98	1.18	0.65	N/A	1
3	KNB.653.38.XX	38mm (1.5")	Brass	1.26	1.57	0.65	N/A	1
4	KNB.653.25.XX	25mm (0.98")	Cast Iron	1.02	1.1	0.65	N/A	1
5	KNB.653.32.XX	32mm (1.26")	Cast Iron	1.02	1.16	0.65	N/A	1
6	KNB.653.38.XX	38mm (1.5")	Cast Iron	1.18	1.57	0.65	N/A	1

“XX” in item code denotes Finish ID.

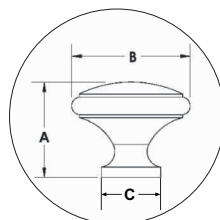

FIG. 1

This product is Supplied with M4x25mm screws.
This product is Supplied with M4x45mm break off screws.

How to Order

KNB.653.25.5

KNOB STYLE : ANVIL SIZE DIAMETER : 25 MM FINISH ID : 5

Anvil Knob Finish Options

Base Material : Cast Iron		Custom Finishes (3-4 Weeks Delivery)*				
 <p>Pewter (Finish ID:1)</p>						
Base Material : Brass		Standard Finishes (2-3 Weeks Delivery)				
 <p>Bright Chrome (Finish ID:2)</p>  <p>Brush Nickel (Finish ID:3)</p>  <p>Aged Brass (Finish ID:4)</p>  <p>Oil Rubbed Bronze (Finish ID:5)</p>  <p>Untacquered Polished Brass (Finish ID:7U)</p>  <p>Polished Nickel (Finish ID:8)</p>  <p>Satin Brass (Finish ID:13)</p>						
Base Material : Brass		Custom Finishes (3-4 Weeks Delivery)*				
 <p>Lacquered Polished Brass (Finish ID:7L)</p>  <p>Antique Copper (Finish ID:15)</p>  <p>Matte Black (Finish ID:19)</p>  <p>English Metallic Bronze (Finish ID:51)</p>  <p>Graphite (Finish ID:61)</p>  <p>Ombre (Finish ID:92)</p>  <p>Brush Chrome (Finish ID:95)</p>						

- Custom finishes cannot be returned or refunded. We are unable to accept cancellations for custom finish order unless within 48 hours of the order being placed.
- We have uniform pricing for all non-hammered finishes listed above as long as base material and size is same.
- Contact us for customized finishes, refer pages F1, F2, F3 & F4 for finish glossary.
- Backplate options refer page KBP1-1 to KBP14-1.

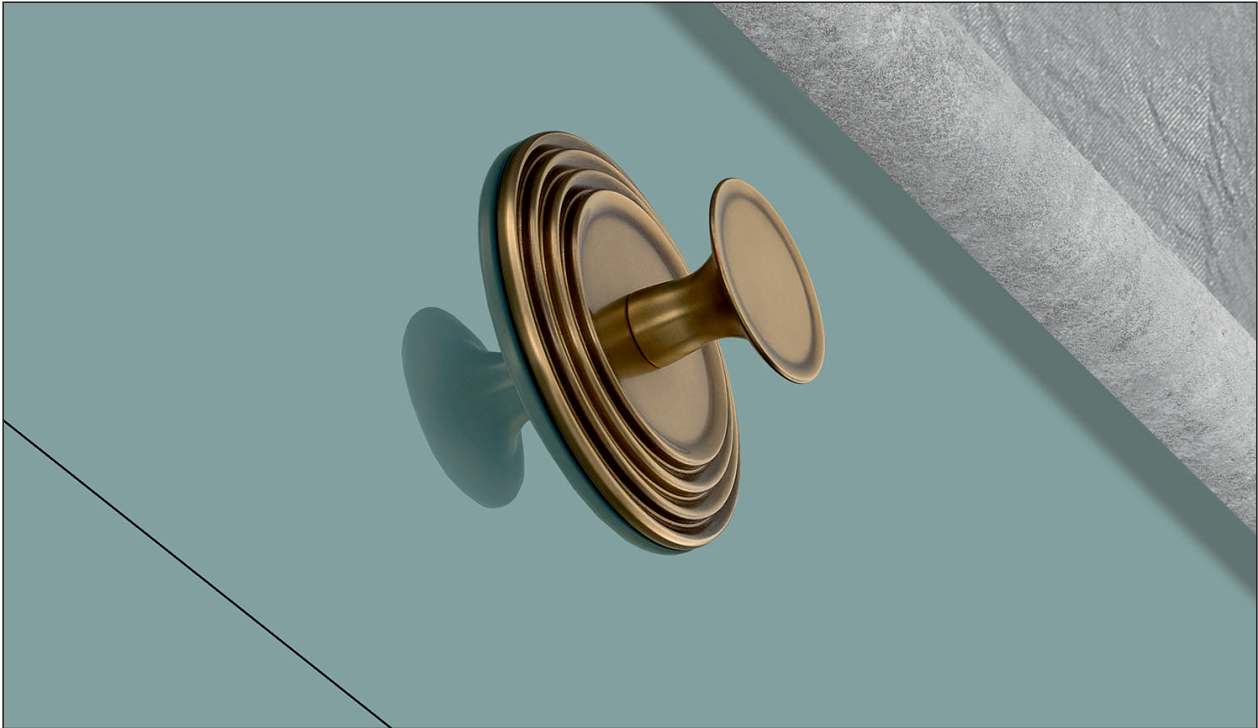

Aged Brass (Finish ID : 4)

MYTH KNOB

	Item Code	Size (mm & Inches)	Material	Size (Inches)				Fig.
				A	B	C	D	
1	KNB.655.25.XX	25mm (0.98")	Brass	0.93	0.98	1.97	N/A	1
2	KNB.655.32.XX	32mm (1.26")	Brass	1.05	1.26	2.52	N/A	1
3	KNB.655.38.XX	38mm (1.5")	Brass	1.24	1.5	2.99	N/A	1
4	KNB.655.2".XX	50.8mm (2")	Brass	1.7	1.97	4.5	N/A	1

"XX" in item code denotes Finish ID.

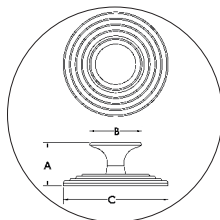

FIG. 1





























This product is Supplied with M4x30mm screws.
This product is Supplied with M4x45mm break off screws.

How to Order

KNB.655.25.4

KNOB STYLE : MYTH SIZE DIAMETER : 25 MM FINISH ID : 4

Myth Knob Finish Options

Base Material : Brass			Standard Finishes (2-3 Weeks Delivery)			
						
Bright Chrome (Finish ID:2)	Brush Nickel (Finish ID:3)	Aged Brass (Finish ID:4)	Oil Rubbed Bronze (Finish ID:5)	Unlacquered Polished Brass (Finish ID:7U)	Polished Nickel (Finish ID:8)	Satin Brass (Finish ID:13)
Base Material : Brass			Custom Finishes (3-4 Weeks Delivery)*			
						
Lacquered Polished Brass (Finish ID:7L)	Antique Copper (Finish ID:15)	Matte Black (Finish ID:19)	Split Black and Polished Nickel with Polished Nickel Back Plate (Finish ID:48A)	Split Black and Polished Nickel with Black Back Plate (Finish ID:48B)	Split Black and Satin Brass with Satin Brass Back Plate (Finish ID:49A)	Split Black and Satin Brass with Black Back Plate (Finish ID:49B)
						
Split Satin Brass and White with Satin Brass Back Plate (Finish ID:50A)	Split Satin Brass and White with White Back Plate (Finish ID:50B)	English Metallic Bronze (Finish ID:51)	Split Polished Brass and Oil Rubbed Bronze with Polished Brass Back Plate (Finish ID:57A)	Split Polished Brass and Oil Rubbed Bronze with Oil Rubbed Bronze Back Plate (Finish ID:57B)	Satin Copper (Finish ID:58)	Split Black and Chrome with Chrome Back Plate (Finish ID:59A)
						
Split Black and Chrome with Black Back Plate (Finish ID:59B)	Split Satin Copper and Oil Rubbed Bronze with Satin Copper Back Plate (Finish ID:60A)	Split Satin Copper and Oil Rubbed Bronze with Oil Rubbed Bronze Back Plate (Finish ID:60B)	Graphite (Finish ID:61)	Split Aged Brass and English Metallic Bronze with Aged Brass Back Plate (Finish ID:75A)	Split Aged Brass and English Metallic Bronze with English Metallic Bronze Back Plate (Finish ID:75B)	Split Polished Nickel and Satin Brass with Satin Brass Back Plate (Finish ID:77A)

- Custom finishes cannot be returned or refunded. We are unable to accept cancellations for custom finish order unless within 48 hours of the order being placed.
- We have uniform pricing for all non-hammered finishes listed above as long as base material and size is same.
- Contact us for customized finishes, refer pages F1, F2, F3 & F4 for finish glossary.
- Backplate options refer page KBP1-1 to KBP14-1.

Base Material : Brass		Custom Finishes (3-4 Weeks Delivery)*				
 Split Polished Nickel and Satin Brass with Polished Nickel Back Plate (Finish ID:77B)	 Split Brush Nickel and Satin Brass with Satin Brass Back Plate (Finish ID:78A)	 Split Brush Nickel and Satin Brass with Brush Nickel Back Plate (Finish ID:78B)	 Titanium (Finish ID:79)	 Split Oil Rubbed Bronze And Satin Brass with Satin Brass Back Plate (Finish ID:80A)	 Split Oil Rubbed Bronze And Satin Brass with Oil Rubbed Bronze Back Plate (Finish ID:80B)	 Split Graphite and Satin Brass with Satin Brass Back Plate (Finish ID:90A)
 Split Graphite and Satin Brass with Graphite Back Plate (Finish ID:90B)	 Split Graphite and Brush Chrome with Graphite Back Plate (Finish ID:91A)	 Split Graphite and Brush Chrome with Brush Chrome Back Plate (Finish ID:91B)	 Ombre (Finish ID:92)	 Brush Chrome (Finish ID:95)		

- Custom finishes cannot be returned or refunded. We are unable to accept cancellations for custom finish order unless within 48 hours of the order being placed.
- We have uniform pricing for all non-hammered finishes listed above as long as base material and size is same.
- Contact us for customized finishes, refer pages F1, F2, F3 & F4 for finish glossary.
- Backplate options refer page KBP1-1 to KBP14-1.

Myth Knob Split Finish

KNB.655.XX.XX

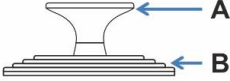
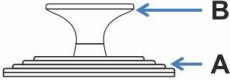
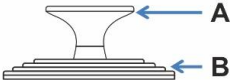
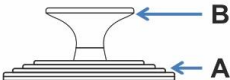
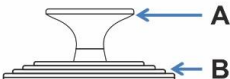
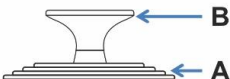
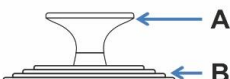
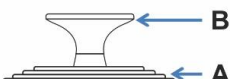
FINISH CODE (XX)	FINISH NAME	LINE DRAWING	A	B
KNB.655.XX.48A	Split Black and Nickel with Polished Nickel Back Plate		Matte Black	Polished Nickel
KNB.655.XX.48B	Split Black and Nickel with Black Back Plate		Matte Black	Polished Nickel
KNB.655.XX.49A	Split Black and Satin Brass with Satin Brass Back Plate		Matte Black	Satin Brass
KNB.655.XX.49B	Split Black and Satin Brass with Black Back Plate		Matte Black	Satin Brass
KNB.655.XX.50A	Split Satin Brass and White with Satin Brass Back Plate		White Epoxy	Satin Brass
KNB.655.XX.50B	Split Satin Brass and White with White Back Plate		White Epoxy	Satin Brass
KNB.655.XX.57A	Split Lacquered Polished Brass and Oil Rubbed Bronze with Lacquered Polished Brass Back Plate		Oil Rubbed Bronze	Lacquered Polished Brass
KNB.655.XX.57B	Split Lacquered Polished Brass and Oil Rubbed Bronze with Oil Rubbed Bronze Back Plate		Oil Rubbed Bronze	Lacquered Polished Brass

Myth Knob Split Finish

KNB.655.XX.XX

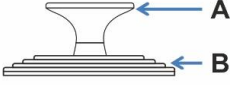
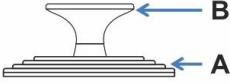
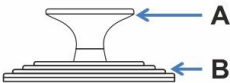
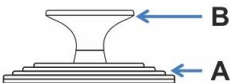
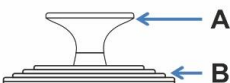
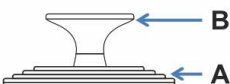
FINISH CODE (XX)	FINISH NAME	LINE DRAWING	A	B
KNB.655.XX.59A	Split Black and chrome with chrome back plate		Matte Black	Bright Chrome
KNB.608.XX.59B	Split Black and chrome / Black back plate		Matte Black	Bright Chrome
KNB.655.XX.60A	Split Satin Copper and Oil Rubbed Bronze with Satin Copper Back Plate		Oil Rubbed Bronze	Satin Copper
KNB.655.XX.60B	Split Satin Copper and Oil Rubbed Bronze with Oil Rubbed Bronze Back Plate		Oil Rubbed Bronze	Satin Copper
KNB.655.XX.75A	Split Aged Brass and English Metallic Bronze with Aged Brass Back Plate		English Metallic Bronze	Aged Brass
KNB.655.XX.75B	Split Aged Brass and English Metallic Bronze with English Metallic Bronze Back Plate		English Metallic Bronze	Aged Brass
KNB.655.XX.77A	Split Polished Nickel and Satin Brass with Satin Brass Back Plate		Polished Nickel	Satin Brass
KNB.655.XX.77B	Split Polished Nickel and Satin Brass with Polished Nickel Back Plate		Polished Nickel	Satin Brass

Myth Knob Split Finish

KNB.655.XX.XX

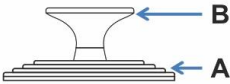
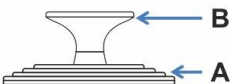
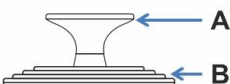
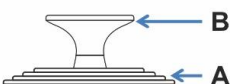
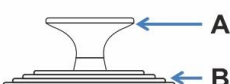
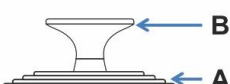
FINISH CODE (XX)	FINISH NAME	LINE DRAWING	A	B
KNB.655.XX.78A	Split Brush Nickel and Satin Brass with Satin Brass Back Plate		Brush Nickel	Satin Brass
KNB.655.XX.78B	Split Brush Nickel and Satin Brass with Brush Nickel Back Plate		Brush Nickel	Satin Brass
KNB.655.XX.80A	Split Oil Rubbed Bronze and Satin Brass with Satin Brass Back Plate		Oil Rubbed Bronze	Satin Brass
KNB.655.XX.80B	Split Oil Rubbed Bronze and Satin Brass with Oil Rubbed Bronze Back Plate		Oil Rubbed Bronze	Satin Brass
KNB.655.XX.90A	Split Graphite and Satin Brass with Satin Brass Back Plate		Graphite	Satin Brass
KNB.655.XX.90B	Split Graphite and Satin Brass with Graphite Back Plate		Graphite	Satin Brass
KNB.655.XX.91A	Split Graphite and Brush Chrome with Brush Chrome Back Plate		Graphite	Brush Chrome
KNB.655.XX.91B	Split Graphite and Brush Chrome with Graphite Back Plate		Graphite	Brush Chrome



Antique Copper (Finish ID : 15)

RAGA KNOB

	Item Code	Size (mm & Inches)	Material	Size (Inches)				Fig.
				A	B	C	D	
1	KNB.656.32.XX	32mm (1.26")	Brass	0.98	1.26	N/A	N/A	1
2	KNB.656.38.XX	38mm (1.5")	Brass	1.14	1.5	N/A	N/A	1

"XX" in item code denotes Finish ID.

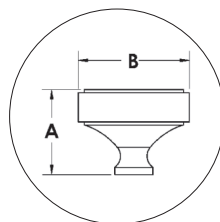

FIG. 1

This product is Supplied with M4x25mm screws.
This product is Supplied with M4x45mm break off screws.

How to Order

KNB.656.32.15

KNOB STYLE : RAGA SIZE DIAMETER : 32 MM FINISH ID : 15

Raga Knob Finish Options

Base Material : Brass		Standard Finishes (2-3 Weeks Delivery)			
					
Bright Chrome (Finish ID:2)	Brush Nickel (Finish ID:3)	Aged Brass (Finish ID:4)	Oil Rubbed Bronze (Finish ID:5)	Polished Nickel (Finish ID:8)	Satin Brass (Finish ID:13)
Base Material : Brass		Custom Finishes (3-4 Weeks Delivery)*			
					
Antique Copper (Finish ID:15)	Graphite (Finish ID:61)	Ombre (Finish ID:92)	Brush Chrome (Finish ID:95)		

- Custom finishes cannot be returned or refunded. We are unable to accept cancellations for custom finish order unless within 48 hours of the order being placed.
- We have uniform pricing for all non-hammered finishes listed above as long as base material and size is same.
- Contact us for customized finishes, refer pages F1, F2, F3 & F4 for finish glossary.
- Backplate options refer page KBP1-1 to KBP14-1.



Satin Brass (Finish ID:13)

ZARA KNOB

	Item Code	Size (mm & Inches)	Material	Size (Inches)				Fig.
				A	B	C	D	
1	KNB.657.32.XX	32mm (1.26")	Brass	0.98	1.26	N/A	N/A	1
2	KNB.657.38.XX	38mm (1.5")	Brass	1.14	1.5	N/A	N/A	1

"XX" in item code denotes Finish ID.

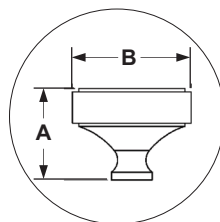

FIG. 1

This product is Supplied with M4x25mm screws.
This product is Supplied with M4x45mm break off screws.

How to Order

KNB.657.32.13

KNOB STYLE : ZARA SIZE DIAMETER : 32 MM FINISH ID : 13

Zara Knob Finish Options

Base Material : Brass		Standard Finishes (2-3 Weeks Delivery)				
						
Bright Chrome (Finish ID:2)	Brush Nickel (Finish ID:3)	Aged Brass (Finish ID:4)	Oil Rubbed Bronze (Finish ID:5)	Unlacquered Polished Brass (Finish ID:7U)	Polished Nickel (Finish ID:8)	Satin Brass (Finish ID:13)
Base Material : Brass		Custom Finishes (3-4 Weeks Delivery)*				
						
Lacquered Polished Brass (Finish ID:7L)	Antique Copper (Finish ID:15)	Matte Black (Finish ID:19)	Rose Gold (Finish ID:33)	Graphite (Finish ID:61)	Titanium (Finish ID:79)	Ombre (Finish ID:92)
						
Brush Chrome (Finish ID:95)						

- Custom finishes cannot be returned or refunded. We are unable to accept cancellations for custom finish order unless within 48 hours of the order being placed.
- We have uniform pricing for all non-hammered finishes listed above as long as base material and size is same.
- Contact us for customized finishes, refer pages F1, F2, F3 & F4 for finish glossary.
- Backplate options refer page KBP1-1 to KBP14-1.



Split Black And Brush Brass (Finish ID : 49)

NOVA KNOB

	Item Code	Size (mm & Inches)	Material	Size (Inches)				Fig.
				A	B	C	D	
1	KNB.658.32.XX	32mm (1.26")	Brass	0.98	1.26	N/A	N/A	1
2	KNB.658.38.XX	38mm (1.5")	Brass	1.14	1.5	N/A	N/A	1

"XX" in item code denotes Finish ID.

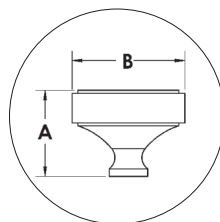

FIG. 1





























This product is Supplied with M4x25mm screws.
This product is Supplied with M4x45mm break off screws.

How to Order

KNB.658.32.49

KNOB STYLE : NOVA SIZE DIAMETER : 32 MM FINISH ID : 49

Nova Knob Finish Options

Base Material : Brass			Standard Finishes (2-3 Weeks Delivery)			
						
Bright Chrome (Finish ID:2)	Brush Nickel (Finish ID:3)	Aged Brass (Finish ID:4)	Oil Rubbed Bronze (Finish ID:5)	Unlacquered Polished Brass (Finish ID:7U)	Polished Nickel (Finish ID:8)	Satin Brass (Finish ID:13)
Base Material : Brass			Custom Finishes (3-4 Weeks Delivery)*			
						
Lacquered Polished Brass (Finish ID:7L)	Antique Copper (Finish ID:15)	Matte Black (Finish ID:19)	Rose Gold (Finish ID:33)	White Epoxy (Finish ID:42)	Split Black and Polished Nickel (Finish ID:48)	Split Black and Satin Brass (Finish ID:49)
						
Split Satin Brass and White (Finish ID:50)	English Metallic Bronze (Finish ID:51)	Split Polished Brass And Oil Rubbed Bronze (Finish ID:57)	Split Black And Chrome (Finish ID:59)	Split Satin Copper And Oil Rubbed Bronze (Finish ID:60)	Graphite (Finish ID:61)	Split Aged Brass And English Metallic Bronze (Finish ID:75)
						
Split Polished Nickel And Satin Brass (Finish ID:77)	Split Brush Nickel and Satin Brass (Finish ID:78)	Titanium (Finish ID:79)	Split Oil Rubbed Bronze and Satin Brass (Finish ID:80)	Split Graphite and Satin Brass (Finish ID:90)	Split Graphite and Brush Chrome (Finish ID:91)	Ombre (Finish ID:92)
						
Brush Chrome (Finish ID:95)						

- Custom finishes cannot be returned or refunded. We are unable to accept cancellations for custom finish order unless within 48 hours of the order being placed.
- We have uniform pricing for all non-hammered finishes listed above as long as base material and size is same.
- Contact us for customized finishes, refer pages F1, F2, F3 & F4 for finish glossary.
- Backplate options refer page KBP1-1 to KBP14-1.

Nova Knob Split Finish

KNB.658.XX.XX

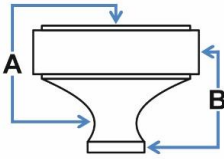
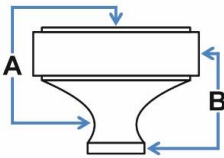
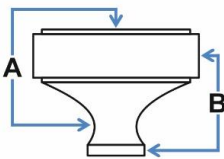
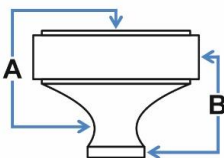
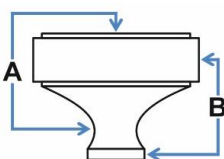
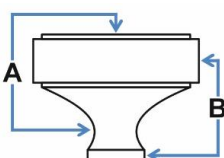
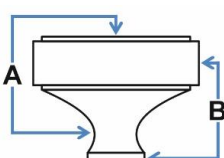
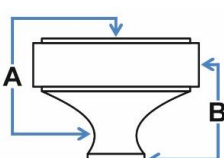
FINISH CODE (XX)	FINISH NAME	LINE DRAWING	A	B
KNB.658.XX.48	Split Black and Polished Nickel		Matte Black	Polished Nickel
KNB.658.XX.49	Split Black and Satin Brass		Matte Black	Satin Brass
KNB.658.XX.50	Split Satin Brass and White		White Epoxy	Satin Brass
KNB.658.XX.57	Split Polished Brass and Oil Rubbed Bronze		Oil Rubbed Bronze	Lacquered Polished Brass
KNB.658.XX.59	Split Black and Chrome		Matte Black	Bright Chrome
KNB.658.XX.60	Split Satin Copper and Oil Rubbed Bronze		Oil Rubbed Bronze	Satin Copper
KNB.658.XX.75	Split Aged Brass and English Metallic Bronze		English Metallic Bronze	Aged Brass
KNB.658.XX.77	Split Polished Nickel and Satin Brass		Satin Brass	Polished Nickel

Nova Knob Split Finish

KNB.658.XX.XX

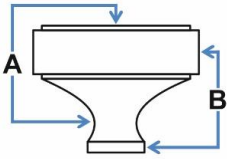
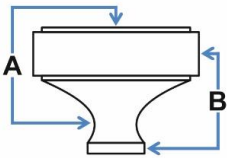
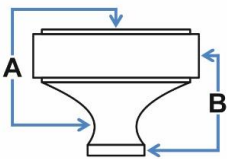
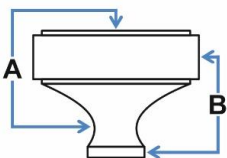
FINISH CODE (XX)	FINISH NAME	LINE DRAWING	A	B
KNB.658.XX.78	Split Brush Nickel and Satin Brass		Brush Nickel	Satin Brass
KNB.613.XX.80	Split Oil Rubbed Bronze and Satin Brass		Oil Rubbed Bronze	Satin Brass
KNB.658.XX.90	Split Graphite and Satin Brass		Graphite	Satin Brass
KNB.658.XX.91	Split Graphite and Brush Chrome		Graphite	Brush Chrome



Titanium (Finish ID : 79)

CHLOEU KNOB

“This soft, well balanced reflective design offers the perfect contrast to more masculine textured surfaces or where distinctive wood grains are the dominant feature.”

	Item Code	Size (mm & Inches)	Material	Size (Inches)				Fig.
				A	B	C	D	
1	KNB.687.32.XX	32mm (1.26")	Brass	1.34	1.26	1.18	N/A	1
2	KNB.687.38.XX	38mm (1.5")	Brass	1.42	1.5	1.42	N/A	1

“XX” in item code denotes Finish ID.

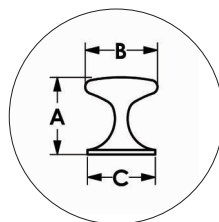
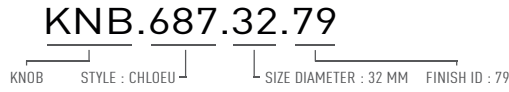

FIG. 1

This product is Supplied with M4x25mm screws.
This product is Supplied with M4x45mm break off screws.

How to Order



Chloeu Knob Finish Options

Base Material : Brass		Standard Finishes (2-3 Weeks Delivery)				
						
Bright Chrome (Finish ID:2)	Brush Nickel (Finish ID:3)	Aged Brass (Finish ID:4)	Oil Rubbed Bronze (Finish ID:5)	Unlacquered Polished Brass (Finish ID:7U)	Polished Nickel (Finish ID:8)	Satin Brass (Finish ID:13)
Base Material : Brass		Custom Finishes (3-4 Weeks Delivery)*				
						
Lacquered Polished Brass (Finish ID:7L)	Antique Copper (Finish ID:15)	Matte Black (Finish ID:19)	Rose Gold (Finish ID:33)	English Metallic Bronze (Finish ID:51)	Graphite (Finish ID:61)	Titanium (Finish ID:79)
						
Ombre (Finish ID:92)	Brush Chrome (Finish ID:95)					

- Custom finishes cannot be returned or refunded. We are unable to accept cancellations for custom finish order unless within 48 hours of the order being placed.
- We have uniform pricing for all non-hammered finishes listed above as long as base material and size is same.
- Contact us for customized finishes, refer pages F1, F2, F3 & F4 for finish glossary.
- Backplate options refer page KBP1-1 to KBP14-1.

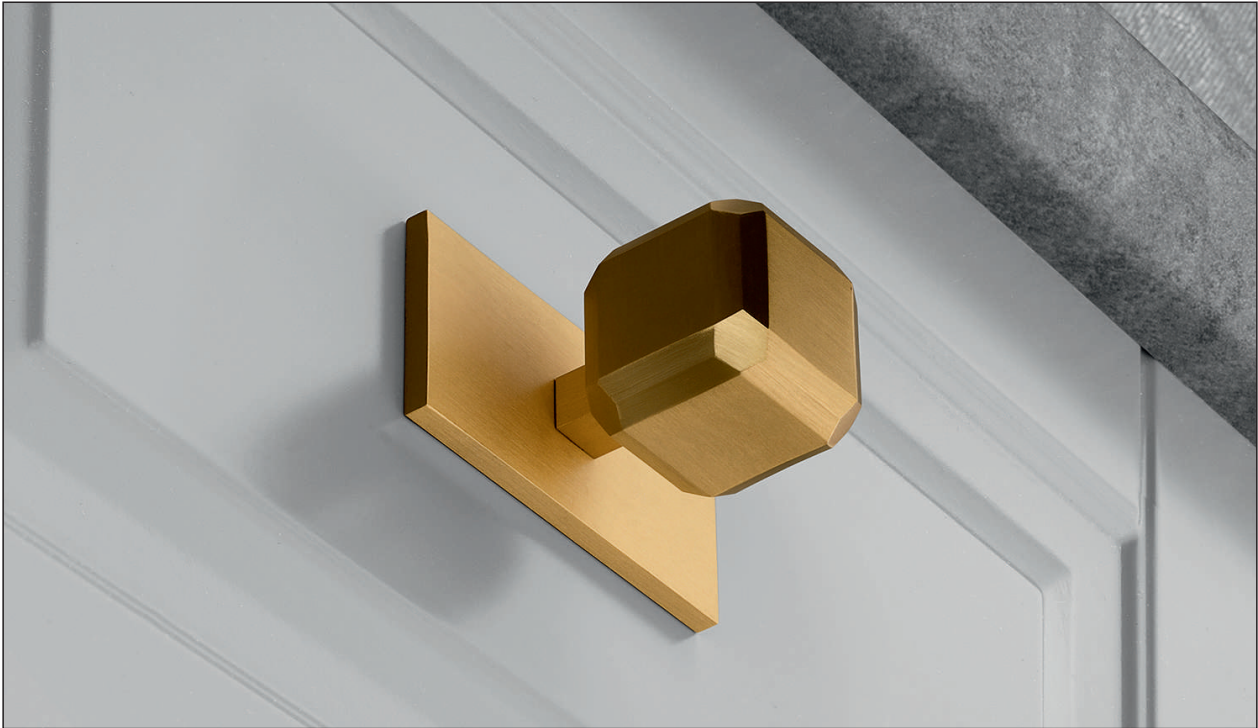

Satin Brass (Finish ID : 13)

WRIGHT PERLA KNOB

“The Taj Mahal is a universally revered architectural masterpiece of world heritage, the bevelled geometric shape of the base of the Taj is the inspiration behind Wright Perla.”

	Item Code	Size (mm & Inches)	Material	Size (Inches)				Fig.
				A	B	C	D	
1	KNB.692.25.XX	25mm (0.98")	Brass	1.54	0.98	1.3	2.5	1
2	KNB.692.30.XX	30mm (1.18")	Brass	1.72	1.18	1.3	2.5	1

“XX” in item code denotes Finish ID.

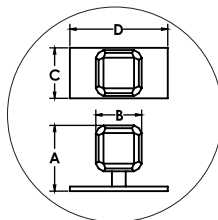

FIG. 1





























This product is Supplied with M4x30mm screws.
This product is Supplied with M4x45mm break off screws.

How to Order

KNB.692.25.13

KNOB STYLE : WRIGHT PERLA SIZE DIAMETER : 25 MM FINISH ID : 13

Wright Perla Knob Finish Options

Base Material : Brass		Standard Finishes (2-3 Weeks Delivery)				
						
Bright Chrome (Finish ID:2)	Brush Nickel (Finish ID:3)	Aged Brass (Finish ID:4)	Oil Rubbed Bronze (Finish ID:5)	Unlacquered Polished Brass (Finish ID:7U)	Polished Nickel (Finish ID:8)	Satin Brass (Finish ID:13)
Base Material : Brass		Custom Finishes (3-4 Weeks Delivery)*				
						
Lacquered Polished Brass (Finish ID:7L)	Matte Black (Finish ID:19)	Split Black and Polished Nickel with Polished Nickel Back Plate (Finish ID:48A)	Split Black and Polished Nickel with Black Back Plate (Finish ID:48B)	Split Black and Satin Brass with Satin Brass Back Plate (Finish ID:49A)	Split Black and Satin Brass with Black Back Plate (Finish ID:49B)	Split Satin Brass and White with Satin Brass Back Plate (Finish ID:50A)
						
Split Satin Brass and White with White Back Plate (Finish ID:50B)	English Metallic Bronze (Finish ID:51)	Split Polished Brass and Oil Rubbed Bronze with Polished Brass Back Plate (Finish ID:57A)	Split Polished Brass and Oil Rubbed Bronze with Oil Rubbed Bronze Back Plate (Finish ID:57B)	Split Black and Chrome with Chrome Back Plate (Finish ID:59A)	Split Black and Chrome with Black Back Plate (Finish ID:59B)	Split Satin Copper and Oil Rubbed Bronze with Satin Copper Back Plate (Finish ID:60A)
						
Split Satin Copper and Oil Rubbed Bronze with Oil Rubbed Bronze Back Plate (Finish ID:60B)	Graphite (Finish ID:61)	Split Aged Brass and English Metallic Bronze with Aged Brass Back Plate (Finish ID:75A)	Split Aged Brass and English Metallic Bronze with English Metallic Bronze Back Plate (Finish ID:75B)	Split Polished Nickel and Satin Brass with Satin Brass Back Plate (Finish ID:77A)	Split Polished Nickel and Satin Brass with Polished Nickel Back Plate (Finish ID:77B)	Split Brush Nickel and Satin Brass with Satin Brass Back Plate (Finish ID:78A)

- Custom finishes cannot be returned or refunded. We are unable to accept cancellations for custom finish order unless within 48 hours of the order being placed.
- We have uniform pricing for all non-hammered finishes listed above as long as base material and size is same.
- Contact us for customized finishes, refer pages F1, F2, F3 & F4 for finish glossary.
- Backplate options refer page KBP1-1 to KBP14-1.

Base Material : Brass		Custom Finishes (3-4 Weeks Delivery)*				
						
Split Brush Nickel and Satin Brass with Brush Nickel Back Plate (Finish ID:78B)	Titanium (Finish ID:79)	Split Oil Rubbed Bronze And Satin Brass with Satin Brass Back Plate (Finish ID:80A)	Split Oil Rubbed Bronze And Satin Brass with Oil Rubbed Bronze Back Plate (Finish ID:80B)	Split Graphite and Satin Brass with Satin Brass Back Plate (Finish ID:90A)	Split Graphite and Satin Brass with Graphite Back Plate (Finish ID:90B)	Split Graphite and Brush Chrome with Graphite Back Plate (Finish ID:91A)
						
Split Graphite and Brush Chrome with Brush Chrome Back Plate (Finish ID:91B)	Ombre (Finish ID:92)	Brush Chrome (Finish ID:95)				

- Custom finishes cannot be returned or refunded. We are unable to accept cancellations for custom finish order unless within 48 hours of the order being placed.
- We have uniform pricing for all non-hammered finishes listed above as long as base material and size is same.
- Contact us for customized finishes, refer pages F1, F2, F3 & F4 for finish glossary.
- Backplate options refer page KBP1-1 to KBP14-1.

Wright Perla Knob Split Finish

KNB.692.XX.XX

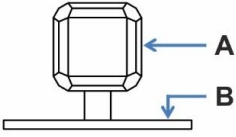
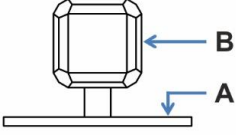
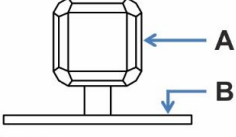
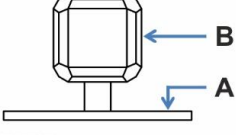
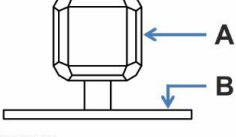
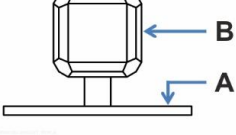
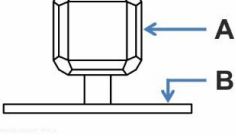
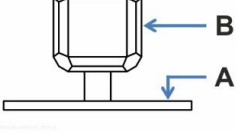
FINISH CODE (XX)	FINISH NAME	LINE DRAWING	A	B
KNB.692.XX.48A	Split Black and Nickel with Polished Nickel Back Plate		Matte Black	Polished Nickel
KNB.692.XX.48B	Split Black and Nickel with Black Back Plate		Matte Black	Polished Nickel
KNB.692.XX.49A	Split Black and Satin Brass with Satin Brass Back Plate		Matte Black	Satin Brass
KNB.692.XX.49B	Split Black and Satin Brass with Black Back Plate		Matte Black	Satin Brass
KNB.692.XX.50A	Split Satin Brass and White with Satin Brass Back Plate		White Epoxy	Satin Brass
KNB.692.XX.50B	Split Satin Brass and White with White Back Plate		White Epoxy	Satin Brass
KNB.692.XX.57A	Split Lacquered Polished Brass and Oil Rubbed Bronze with Lacquered Polished Brass Back Plate		Oil Rubbed Bronze	Lacquered Polished Brass
KNB.692.XX.57B	Split Lacquered Polished Brass and Oil Rubbed Bronze with Oil Rubbed Bronze Back Plate		Oil Rubbed Bronze	Lacquered Polished Brass

Wright Perla Knob Split Finish

KNB.692.XX.XX

FINISH CODE (XX)	FINISH NAME	LINE DRAWING	A	B
KNB.692.XX.59A	Split Black and chrome with chrome back plate		Matte Black	Bright Chrome
KNB.692.XX.59B	Split Black and chrome / Black back plate		Matte Black	Bright Chrome
KNB.692.XX.60A	Split Satin Copper and Oil Rubbed Bronze with Satin Copper Back Plate		Oil Rubbed Bronze	Satin Copper
KNB.692.XX.60B	Split Satin Copper and Oil Rubbed Bronze with Oil Rubbed Bronze Back Plate		Oil Rubbed Bronze	Satin Copper
KNB.692.XX.75A	Split Aged Brass and English Metallic Bronze with Aged Brass Back Plate		English Metallic Bronze	Aged Brass
KNB.692.XX.75B	Split Aged Brass and English Metallic Bronze with English Metallic Bronze Back Plate		English Metallic Bronze	Aged Brass
KNB.692.XX.77A	Split Polished Nickel and Satin Brass with Satin Brass Back Plate		Polished Nickel	Satin Brass
KNB.692.XX.77B	Split Polished Nickel and Satin Brass with Polished Nickel Back Plate		Polished Nickel	Satin Brass

Wright Perla Knob Split Finish

KNB.692.XX.XX

FINISH CODE (XX)	FINISH NAME	LINE DRAWING	A	B
KNB.692.XX.78A	Split Brush Nickel and Satin Brass with Satin Brass Back Plate		Brush Nickel	Satin Brass
KNB.692.XX.78B	Split Brush Nickel and Satin Brass with Brush Nickel Back Plate		Brush Nickel	Satin Brass
KNB.692.XX.80A	Split Oil Rubbed Bronze and Satin Brass with Satin Brass Back Plate		Oil Rubbed Bronze	Satin Brass
KNB.692.XX.80B	Split Oil Rubbed Bronze and Satin Brass with Oil Rubbed Bronze Back Plate		Oil Rubbed Bronze	Satin Brass
KNB.692.XX.90A	Split Graphite and Satin Brass with Satin Brass Back Plate		Graphite	Satin Brass
KNB.692.XX.90B	Split Graphite and Satin Brass with Graphite Back Plate		Graphite	Satin Brass
KNB.692.XX.91A	Split Graphite and Brush Chrome with Brush Chrome Back Plate		Graphite	Brush Chrome
KNB.692.XX.91B	Split Graphite and Brush Chrome with Graphite Back Plate		Graphite	Brush Chrome



English Metallic Bronze (Finish ID : 51)

WRIGHT PERLA KNOB WITH SQUARE BACK PLATE

“The Taj Mahal is a universally revered architectural masterpiece of world heritage, the bevelled geometric shape of the base of the Taj is the inspiration behind Wright Perla.”

Item Code	Size (mm & Inches)	Material	Size (Inches)				Fig.
			A	B	C	D	
1 KNB.692.30.XX.SQB	30mm (1.18")	Brass	1.81	1.18	1.81	1.81	1

“XX” in item code denotes Finish ID.

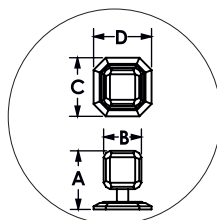

FIG. 1

This product is Supplied with M4x30mm screws.
This product is Supplied with M4x45mm break off screws.

Base Material : Brass		Custom Finishes (3-4 Weeks Delivery)*				
						
Split Brush Nickel and Satin Brass with Brush Nickel Back Plate (Finish ID:78B)	Split Oil Rubbed Bronze And Satin Brass with Satin Brass Back Plate (Finish ID:80A)	Split Oil Rubbed Bronze And Satin Brass with Oil Rubbed Bronze Back Plate (Finish ID:80B)	Split Graphite and Satin Brass with Satin Brass Back Plate (Finish ID:90A)	Split Graphite and Satin Brass with Graphite Back Plate (Finish ID:90B)	Split Graphite and Brush Chrome with Graphite Back Plate (Finish ID:91A)	Split Graphite and Brush Chrome with Brush Chrome Back Plate (Finish ID:91B)
						
Ombre (Finish ID:92)	Brush Chrome (Finish ID:95)					

- Custom finishes cannot be returned or refunded. We are unable to accept cancellations for custom finish order unless within 48 hours of the order being placed.
- We have uniform pricing for all non-hammered finishes listed above as long as base material and size is same.
- Contact us for customized finishes, refer pages F1, F2, F3 & F4 for finish glossary.
- Backplate options refer page KBP1-1 to KBP14-1.

Wright Perla Knob With Square Back Plate Split Finish

KNB.692.XX.XX.SQB

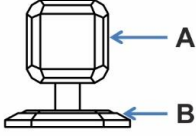
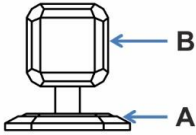
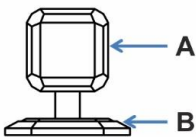
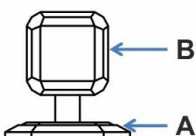
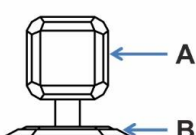
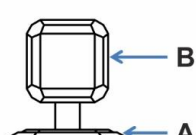
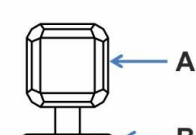
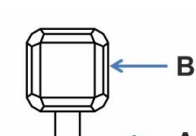
FINISH CODE (XX)	FINISH NAME	LINE DRAWING	A	B
KNB.692.XX.48A.SQB	Split Black and Nickel with Polished Nickel Back Plate		Matte Black	Polished Nickel
KNB.692.XX.48B.SQB	Split Black and Nickel with Black Back Plate		Matte Black	Polished Nickel
KNB.692.XX.49A.SQB	Split Black and Satin Brass with Satin Brass Back Plate		Matte Black	Satin Brass
KNB.692.XX.49B.SQB	Split Black and Satin Brass with Black Back Plate		Matte Black	Satin Brass
KNB.692.XX.50A.SQB	Split Satin Brass and White with Satin Brass Back Plate		White Epoxy	Satin Brass
KNB.692.XX.50B.SQB	Split Satin Brass and White with White Back Plate		White Epoxy	Satin Brass
KNB.692.XX.57A.SQB	Split Lacquered Polished Brass and Oil Rubbed Bronze with Lacquered Polished Brass Back Plate		Oil Rubbed Bronze	Lacquered Polished Brass
KNB.692.XX.57B.SQB	Split Lacquered Polished Brass and Oil Rubbed Bronze with Oil Rubbed Bronze Back Plate		Oil Rubbed Bronze	Lacquered Polished Brass

Wright Perla Knob With Square Back Plate Split Finish

KNB.692.XX.XX.SQB

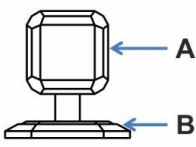
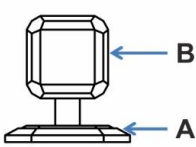
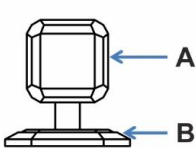
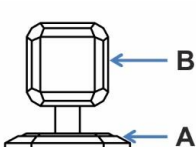
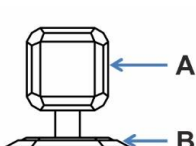
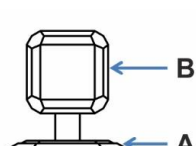
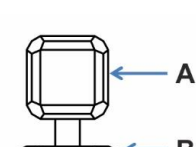
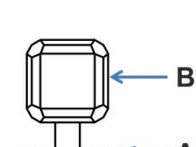
FINISH CODE (XX)	FINISH NAME	LINE DRAWING	A	B
KNB.692.XX.59A.SQB	Split Black and chrome with chrome back plate		Matte Black	Bright Chrome
KNB.692.XX.59B.SQB	Split Black and chrome / Black back plate		Matte Black	Bright Chrome
KNB.692.XX.60A.SQB	Split Satin Copper and Oil Rubbed Bronze with Satin Copper Back Plate		Oil Rubbed Bronze	Satin Copper
KNB.692.XX.60B.SQB	Split Satin Copper and Oil Rubbed Bronze with Oil Rubbed Bronze Back Plate		Oil Rubbed Bronze	Satin Copper
KNB.692.XX.75A.SQB	Split Aged Brass and English Metallic Bronze with Aged Brass Back Plate		English Metallic Bronze	Aged Brass
KNB.692.XX.75B.SQB	Split Aged Brass and English Metallic Bronze with English Metallic Bronze Back Plate		English Metallic Bronze	Aged Brass
KNB.692.XX.77A.SQB	Split Polished Nickel and Satin Brass with Satin Brass Back Plate		Polished Nickel	Satin Brass
KNB.692.XX.77B.SQB	Split Polished Nickel and Satin Brass with Polished Nickel Back Plate		Polished Nickel	Satin Brass

Wright Perla Knob With Square Back Plate Split Finish

KNB.692.XX.XX.SQB

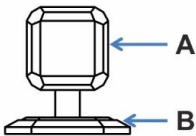
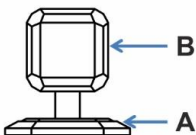
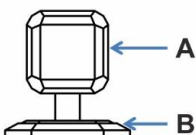
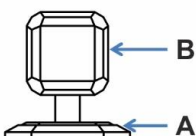
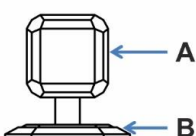
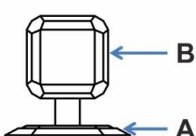
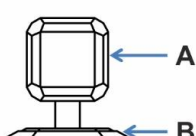
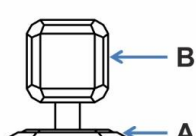
FINISH CODE (XX)	FINISH NAME	LINE DRAWING	A	B
KNB.692.XX.78A.SQB	Split Brush Nickel and Satin Brass with Satin Brass Back Plate		Brush Nickel	Satin Brass
KNB.692.XX.78B.SQB	Split Brush Nickel and Satin Brass with Brush Nickel Back Plate		Brush Nickel	Satin Brass
KNB.692.XX.80A.SQB	Split Oil Rubbed Bronze and Satin Brass with Satin Brass Back Plate		Oil Rubbed Bronze	Satin Brass
KNB.692.XX.80B.SQB	Split Oil Rubbed Bronze and Satin Brass with Oil Rubbed Bronze Back Plate		Oil Rubbed Bronze	Satin Brass
KNB.692.XX.90A.SQB	Split Graphite and Satin Brass with Satin Brass Back Plate		Graphite	Satin Brass
KNB.692.XX.90B.SQB	Split Graphite and Satin Brass with Graphite Back Plate		Graphite	Satin Brass
KNB.692.XX.91A.SQB	Split Graphite and Brush Chrome with Brush Chrome Back Plate		Graphite	Brush Chrome
KNB.692.XX.91B.SQB	Split Graphite and Brush Chrome with Graphite Back Plate		Graphite	Brush Chrome



Aged Brass (Finish ID : 4)

AMBROSE KNOB WITH BACK PLATE

“Our Ambrose cupboard knob seeks inspiration from the Amanita mushroom species, a simple organic shape seeking inspiration from the world around us.”

	Item Code	Size (mm & Inches)	Material	Size (Inches)				Fig.
				A	B	C	D	
1	KNB.694.32.XX	32mm (1.26")	Brass	1.34	1.26	N/A	N/A	1
2	KNB.694.38.XX	38mm (1.5")	Brass	1.46	1.5	N/A	N/A	1

“XX” in item code denotes Finish ID.

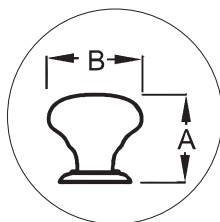

FIG. 1





























This product is Supplied with M4x30mm screws.
This product is Supplied with M4x45mm break off screws.

How to Order

KNB.694.32.4

KNOB STYLE : AMBROSE WITH BACK PLATE SIZE DIAMETER : 32 MM FINISH ID : 4

Ambrose Knob with Back Plate Finish Options

Base Material : Brass		Standard Finishes (2-3 Weeks Delivery)				
						
Bright Chrome (Finish ID:2)	Brush Nickel (Finish ID:3)	Aged Brass (Finish ID:4)	Oil Rubbed Bronze (Finish ID:5)	Unlacquered Polished Brass (Finish ID:7U)	Polished Nickel (Finish ID:8)	Satin Brass (Finish ID:13)
Base Material : Brass		Custom Finishes (3-4 Weeks Delivery)*				
						
Lacquered Polished Brass (Finish ID:7L)	Matte Black (Finish ID:19)	Split Black and Polished Nickel with Polished Nickel Back Plate (Finish ID:48A)	Split Black and Polished Nickel with Black Back Plate (Finish ID:48B)	Split Black and Satin Brass with Satin Brass Back Plate (Finish ID:49A)	Split Black and Satin Brass with Black Back Plate (Finish ID:49B)	Split Satin Brass and White with Satin Brass Back Plate (Finish ID:50A)
						
Split Satin Brass and White with White Back Plate (Finish ID:50B)	English Metallic Bronze (Finish ID:51)	Split Polished Brass and Oil Rubbed Bronze with Polished Brass Back Plate (Finish ID:57A)	Split Polished Brass and Oil Rubbed Bronze with Oil Rubbed Bronze Back Plate (Finish ID:57B)	Split Black and Chrome with Chrome Back Plate (Finish ID:59A)	Split Black and Chrome with Black Back Plate (Finish ID:59B)	Split Satin Copper and Oil Rubbed Bronze with Satin Copper Back Plate (Finish ID:60A)
						
Split Satin Copper and Oil Rubbed Bronze with Oil Rubbed Bronze Back Plate (Finish ID:60B)	Graphite (Finish ID:61)	Split Aged Brass and English Metallic Bronze with Aged Brass Back Plate (Finish ID:75A)	Split Aged Brass and English Metallic Bronze with English Metallic Bronze Back Plate (Finish ID:75B)	Split Polished Nickel and Satin Brass with Satin Brass Back Plate (Finish ID:77A)	Split Polished Nickel and Satin Brass with Polished Nickel Back Plate (Finish ID:77B)	Split Brush Nickel and Satin Brass with Satin Brass Back Plate (Finish ID:78A)

- Custom finishes cannot be returned or refunded. We are unable to accept cancellations for custom finish order unless within 48 hours of the order being placed.
- We have uniform pricing for all non-hammered finishes listed above as long as base material and size is same.
- Contact us for customized finishes, refer pages F1, F2, F3 & F4 for finish glossary.
- Backplate options refer page KBP1-1 to KBP14-1.

Base Material : Brass	Custom Finishes (3-4 Weeks Delivery)*					
						
<p style="font-size: 0.8em; margin: 0;">Split Brush Nickel and Satin Brass with Brush Nickel Back Plate (Finish ID:78B)</p>	<p style="font-size: 0.8em; margin: 0;">Split Oil Rubbed Bronze And Satin Brass with Satin Brass Back Plate (Finish ID:80A)</p>	<p style="font-size: 0.8em; margin: 0;">Split Oil Rubbed Bronze And Satin Brass with Oil Rubbed Bronze Back Plate (Finish ID:80B)</p>	<p style="font-size: 0.8em; margin: 0;">Split Graphite and Satin Brass with Satin Brass Back Plate (Finish ID:90A)</p>	<p style="font-size: 0.8em; margin: 0;">Split Graphite and Satin Brass with Graphite Back Plate (Finish ID:90B)</p>	<p style="font-size: 0.8em; margin: 0;">Split Graphite and Brush Chrome with Graphite Back Plate (Finish ID:91A)</p>	<p style="font-size: 0.8em; margin: 0;">Split Graphite and Brush Chrome with Brush Chrome Back Plate (Finish ID:91B)</p>
						
<p style="font-size: 0.8em; margin: 0;">Ombre (Finish ID:92)</p>	<p style="font-size: 0.8em; margin: 0;">Brush Chrome (Finish ID:95)</p>					

- Custom finishes cannot be returned or refunded. We are unable to accept cancellations for custom finish order unless within 48 hours of the order being placed.
- We have uniform pricing for all non-hammered finishes listed above as long as base material and size is same.
- Contact us for customized finishes, refer pages F1, F2, F3 & F4 for finish glossary.
- Backplate options refer page KBP1-1 to KBP14-1.

Ambrose Knob with Back Plate Split Finish

KNB.694.XX.XX

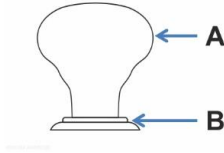
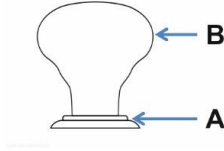
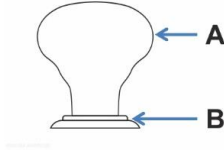
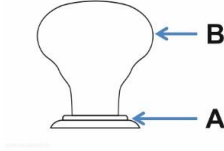
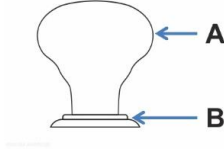
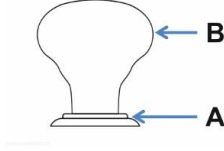
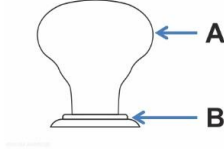
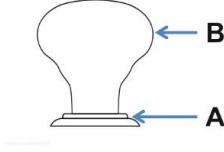
FINISH CODE (XX)	FINISH NAME	LINE DRAWING	A	B
KNB.694.XX.48A	Split Black and Nickel with Polished Nickel Back Plate		Matte Black	Polished Nickel
KNB.694.XX.48B	Split Black and Nickel with Black Back Plate		Matte Black	Polished Nickel
KNB.694.XX.49A	Split Black and Satin Brass with Satin Brass Back Plate		Matte Black	Satin Brass
KNB.694.XX.49B	Split Black and Satin Brass with Black Back Plate		Matte Black	Satin Brass
KNB.694.XX.50A	Split Satin Brass and White with Satin Brass Back Plate		White Epoxy	Satin Brass
KNB.694.XX.50B	Split Satin Brass and White with White Back Plate		White Epoxy	Satin Brass
KNB.694.XX.57A	Split Lacquered Polished Brass and Oil Rubbed Bronze with Lacquered Polished Brass Back Plate		Oil Rubbed Bronze	Lacquered Polished Brass
KNB.694.XX.57B	Split Lacquered Polished Brass and Oil Rubbed Bronze with Oil Rubbed Bronze Back Plate		Oil Rubbed Bronze	Lacquered Polished Brass

Ambrose Knob with Back Plate Split Finish

KNB.694.XX.XX

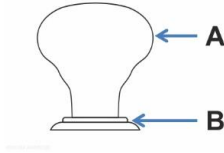
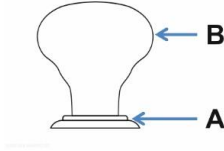
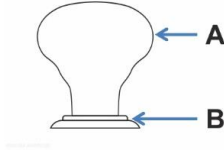
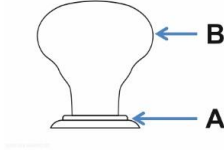
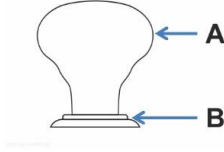
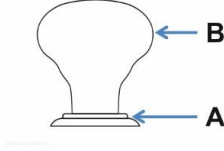
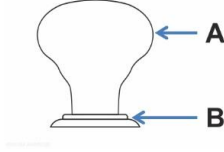
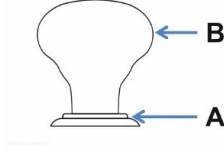
FINISH CODE (XX)	FINISH NAME	LINE DRAWING	A	B
KNB.694.XX.59A	Split Black and chrome with chrome back plate		Matte Black	Bright Chrome
KNB.694.XX.59B	Split Black and chrome / Black back plate		Matte Black	Bright Chrome
KNB.694.XX.60A	Split Satin Copper and Oil Rubbed Bronze with Satin Copper Back Plate		Oil Rubbed Bronze	Satin Copper
KNB.694.XX.60B	Split Satin Copper and Oil Rubbed Bronze with Oil Rubbed Bronze Back Plate		Oil Rubbed Bronze	Satin Copper
KNB.694.XX.75A	Split Aged Brass and English Metallic Bronze with Aged Brass Back Plate		English Metallic Bronze	Aged Brass
KNB.694.XX.75B	Split Aged Brass and English Metallic Bronze with English Metallic Bronze Back Plate		English Metallic Bronze	Aged Brass
KNB.694.XX.77A	Split Polished Nickel and Satin Brass with Satin Brass Back Plate		Polished Nickel	Satin Brass
KNB.694.XX.77B	Split Polished Nickel and Satin Brass with Polished Nickel Back Plate		Polished Nickel	Satin Brass

Ambrose Knob with Back Plate Split Finish

KNB.694.XX.XX

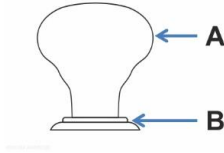
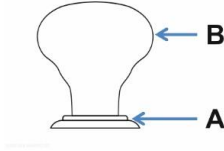
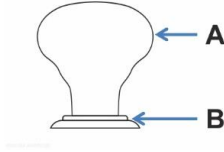
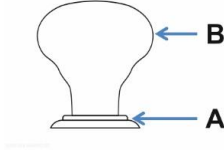
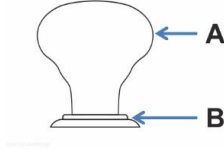
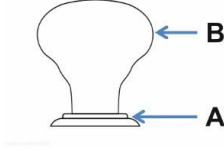
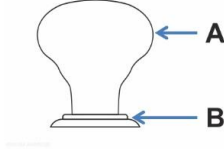
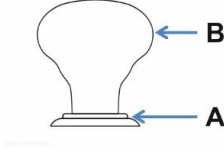
FINISH CODE (XX)	FINISH NAME	LINE DRAWING	A	B
KNB.694.XX.78A	Split Brush Nickel and Satin Brass with Satin Brass Back Plate		Brush Nickel	Satin Brass
KNB.694.XX.78B	Split Brush Nickel and Satin Brass with Brush Nickel Back Plate		Brush Nickel	Satin Brass
KNB.694.XX.80A	Split Oil Rubbed Bronze and Satin Brass with Satin Brass Back Plate		Oil Rubbed Bronze	Satin Brass
KNB.694.XX.80B	Split Oil Rubbed Bronze and Satin Brass with Oil Rubbed Bronze Back Plate		Oil Rubbed Bronze	Satin Brass
KNB.694.XX.90A	Split Graphite and Satin Brass with Satin Brass Back Plate		Graphite	Satin Brass
KNB.694.XX.90B	Split Graphite and Satin Brass with Graphite Back Plate		Graphite	Satin Brass
KNB.694.XX.91A	Split Graphite and Brush Chrome with Brush Chrome Back Plate		Graphite	Brush Chrome
KNB.694.XX.91B	Split Graphite and Brush Chrome with Graphite Back Plate		Graphite	Brush Chrome



Matt Black (Finish ID:19)

CATERPILLAR T KNOB

	Item Code	Size (mm & Inches)	Material	Size (Inches)				Fig.
				A	B	C	D	
1	TKNB.698.50.XX	50mm (1.97")	Brass	1.4	0.59	1.97	N/A	1
2	TKNB.698.90.XX	90mm (3.54")	Brass	1.4	0.59	3.54	N/A	1

"XX" in item code denotes Finish ID.

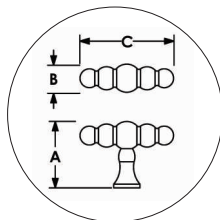

FIG. 1

This product is Supplied with M4x25mm screws.
This product is Supplied with M4x45mm break off screws.

How to Order

TKNB.698.50.19

T KNOB STYLE : CATERPILLAR SIZE DIAMETER : 50 MM FINISH ID : 19

Caterpillar T Knob Finish Options

Base Material : Brass		Standard Finishes (2-3 Weeks Delivery)				
						
Bright Chrome (Finish ID:2)	Brush Nickel (Finish ID:3)	Aged Brass (Finish ID:4)	Oil Rubbed Bronze (Finish ID:5)	Unlacquered Polished Brass (Finish ID:7U)	Polished Nickel (Finish ID:8)	Satin Brass (Finish ID:13)
Base Material : Brass		Custom Finishes (3-4 Weeks Delivery)*				
						
Lacquered Polished Brass (Finish ID:7L)	Antique Copper (Finish ID:15)	Matte Black (Finish ID:19)	Rose Gold (Finish ID:33)	Satin Copper (Finish ID:58)	Graphite (Finish ID:61)	Titanium (Finish ID:79)
						
Ombre (Finish ID:92)	Brush Chrome (Finish ID:95)					

- Custom finishes cannot be returned or refunded. We are unable to accept cancellations for custom finish order unless within 48 hours of the order being placed.
- We have uniform pricing for all non-hammered finishes listed above as long as base material and size is same.
- Contact us for customized finishes, refer pages F1, F2, F3 & F4 for finish glossary.
- Backplate options refer page KBP1-1 to KBP14-1.



Satin Brass (Finish ID:13)

STALK T-KNOB

“Bamboo has been used as a building material for more than 7000 years, more widely understood in the 1920's. Stalk reflects the trend where more and more architects are seeing the beauty, intelligence and sustain ability of using bamboo for construction and surface decoration.”

	Item Code	Size (mm & Inches)	Material	Size (Inches)				Fig.
				A	B	C	D	
1	TKNB.833.55.XX	55mm (2.17")	Brass	1.5	0.59	2.17	N/A	1
2	TKNB.833.90.XX	90mm (3.54")	Brass	1.5	0.59	3.54	N/A	1
3	TKNB.833.55.XX	55mm (2.17")	Bronze	1.42	0.57	2.17	N/A	1
4	TKNB.833.90.XX	90mm (3.54")	Bronze	1.42	0.57	3.54	N/A	1

“XX” in item code denotes Finish ID.

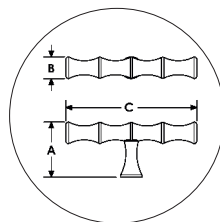

FIG. 1





This product is Supplied with M4x25mm screws.
This product is Supplied with M4x45mm break off screws.

How to Order

TKNB.833.55.13

T KNOB STYLE : STALK SIZE DIAMETER : 55 MM FINISH ID : 13

Stalk T-Knob Finish Options

Base Material : Brass		Standard Finishes (2-3 Weeks Delivery)				
						
Bright Chrome (Finish ID:2)	Brush Nickel (Finish ID:3)	Aged Brass (Finish ID:4)	Oil Rubbed Bronze (Finish ID:5)	Unlacquered Polished Brass (Finish ID:7U)	Polished Nickel (Finish ID:8)	Satin Brass (Finish ID:13)
Base Material : Brass		Custom Finishes (3-4 Weeks Delivery)*				
						
Antique Copper (Finish ID:15)	Matte Black (Finish ID:19)	Rose Gold (Finish ID:33)	Satin Copper (Finish ID:58)	Graphite (Finish ID:61)	Titanium (Finish ID:79)	Ombre (Finish ID:92)
						
Brush Chrome (Finish ID:95)						
Base Material : Bronze		Custom Finishes (3-4 Weeks Delivery)*				
						
Silicon Bronze Light (Finish ID:53)	Silicon Bronze Dark (Finish ID:53D)	White Bronze (Finish ID:54)				

- Custom finishes cannot be returned or refunded. We are unable to accept cancellations for custom finish order unless within 48 hours of the order being placed.
- We have uniform pricing for all non-hammered finishes listed above as long as base material and size is same.
- Contact us for customized finishes, refer pages F1, F2, F3 & F4 for finish glossary.
- Backplate options refer page KBP1-1 to KBP14-1.



Polished Nickel (Finish ID : 8)

ALHAMBRA KNOB

“The architecture of the Alhambra palace is drawn from a mix of cultures and decorative elements, Moorish poets described it as a pearl set in emeralds. Our Alhambra suite is inspired by the columns in the palace, characterised by their elegance rather than grandeur”

	Item Code	Size (mm & Inches)	Material	Size (Inches)				Fig.
				A	B	C	D	
1	KNB.834.25.XX	25mm (0.98")	Brass	1.06	0.98	0.83	N/A	1
2	KNB.834.32.XX	32mm (1.26")	Brass	1.22	1.26	1.1	N/A	1
3	KNB.834.38.XX	38mm (1.5")	Brass	1.4	1.5	1.34	N/A	1

“XX” in item code denotes Finish ID.

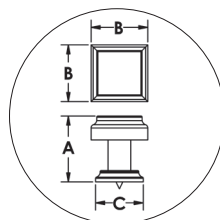

FIG. 1



























This product is Supplied with M4x30mm screws.
This product is Supplied with M4x45mm break off screws.

How to Order

KNB.834.25.8

KNOB STYLE : ALHAMBRA SIZE DIAMETER : 25 MM FINISH ID : 8

Alhambra Knob Finish Options

Base Material : Brass		Standard Finishes (2-3 Weeks Delivery)				
						
Bright Chrome (Finish ID:2)	Brush Nickel (Finish ID:3)	Aged Brass (Finish ID:4)	Oil Rubbed Bronze (Finish ID:5)	Unlacquered Polished Brass (Finish ID:7U)	Polished Nickel (Finish ID:8)	Satin Brass (Finish ID:13)
Base Material : Brass		Custom Finishes (3-4 Weeks Delivery)*				
						
Lacquered Polished Brass (Finish ID:7L)	Antique Copper (Finish ID:15)	Matte Black (Finish ID:19)	Split Black and Polished Nickel (Finish ID:48)	Split Black and Satin Brass (Finish ID:49)	Split Satin Brass and White (Finish ID:50)	English Metallic Bronze (Finish ID:51)
						
Split Polished Brass And Oil Rubbed Bronze (Finish ID:57)	Split Black And Chrome (Finish ID:59)	Split Satin Copper And Oil Rubbed Bronze (Finish ID:60)	Graphite (Finish ID:61)	Split Aged Brass And English Metallic Bronze (Finish ID:75)	Split Polished Nickel And Satin Brass (Finish ID:77)	Split Brush Nickel and Satin Brass (Finish ID:78)
						
Titanium (Finish ID:79)	Split Oil Rubbed Bronze and Satin Brass (Finish ID:80)	Split Graphite and Satin Brass (Finish ID:90)	Split Graphite and Brush Chrome (Finish ID:91)	Ombre (Finish ID:92)	Brush Chrome (Finish ID:95)	

- Custom finishes cannot be returned or refunded. We are unable to accept cancellations for custom finish order unless within 48 hours of the order being placed.
- We have uniform pricing for all non-hammered finishes listed above as long as base material and size is same.
- Contact us for customized finishes, refer pages F1, F2, F3 & F4 for finish glossary.
- Backplate options refer page KBP1-1 to KBP14-1.

Alhambra Knob Split Finish

KNB.834.XX.XX

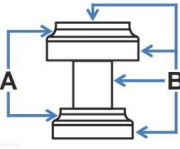
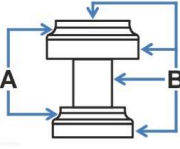
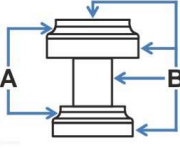
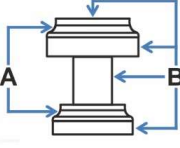
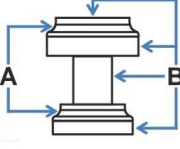
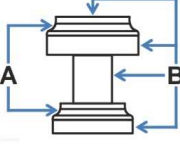
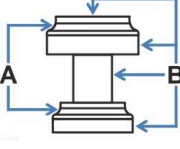
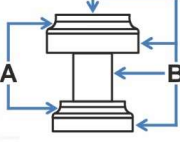
FINISH CODE (XX)	FINISH NAME	LINE DRAWING	A	B
KNB.834.XX.48	Split Black and Polished Nickel		Matte Black	Polished Nickel
KNB.834.XX.49	Split Black and Satin Brass		Matte Black	Satin Brass
KNB.834.XX.50	Split Satin Brass and White		White Epoxy	Satin Brass
KNB.834.XX.57	Split Polished Brass and Oil Rubbed Bronze		Oil Rubbed Bronze	Lacquered Polished Brass
KNB.834.XX.59	Split Black and Chrome		Matte Black	Bright Chrome
KNB.834.XX.60	Split Satin Copper and Oil Rubbed Bronze		Oil Rubbed Bronze	Satin Copper
KNB.834.XX.75	Split Aged Brass and English Metallic Bronze		English Metallic Bronze	Aged Brass
KNB.834.XX.77	Split Polished Nickel and Satin Brass		Satin Brass	Polished Nickel

Alhambra Knob Split Finish

KNB.834.XX.XX

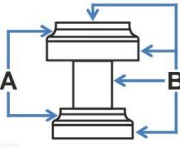
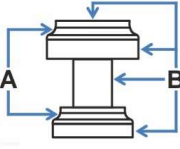
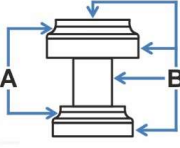
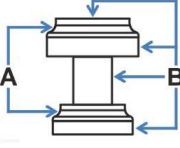
FINISH CODE (XX)	FINISH NAME	LINE DRAWING	A	B
KNB.834.XX.78	Split Brush Nickel and Satin Brass		Brush Nickel	Satin Brass
KNB.834.XX.80	Split Oil Rubbed Bronze and Satin Brass		Oil Rubbed Bronze	Satin Brass
KNB.834.XX.90	Split Graphite and Satin Brass		Graphite	Satin Brass
KNB.834.XX.91	Split Graphite and Brush Chrome		Graphite	Brush Chrome



Oil Rubbed Bronze (Finish ID : 5)

ALHAMBRA T-KNOB

“The architecture of the Alhambra palace is drawn from a mix of cultures and decorative elements, Moorish poets described it as a pearl set in emeralds. Our Alhambra suite is inspired by the columns in the palace, characterised by their elegance rather than grandeur”

	Item Code	Size (mm & Inches)	Material	Size (Inches)				Fig.
				A	B	C	D	
1	TKNB.834.2".XX	50.8mm (2")	Brass	1.22	0.75	2.2	N/A	1
2	TKNB.834.4".XX	101.6mm (4")	Brass	1.22	0.75	4	N/A	1

"XX" in item code denotes Finish ID.

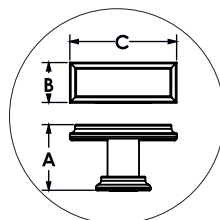
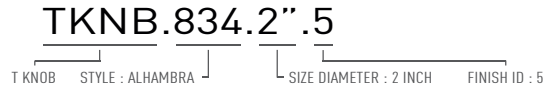

FIG. 1

This product is Supplied with M4x25mm screws.
This product is Supplied with M4x45mm break off screws.

How to Order



Alhambra T Knob Finish Options

Base Material : Brass		Standard Finishes (2-3 Weeks Delivery)				
						
Bright Chrome (Finish ID:2)	Brush Nickel (Finish ID:3)	Aged Brass (Finish ID:4)	Oil Rubbed Bronze (Finish ID:5)	Unlacquered Polished Brass (Finish ID:7U)	Polished Nickel (Finish ID:8)	Satin Brass (Finish ID:13)
Base Material : Brass		Custom Finishes (3-4 Weeks Delivery)*				
						
Lacquered Polished Brass (Finish ID:7L)	Antique Copper (Finish ID:15)	Matte Black (Finish ID:19)	Graphite (Finish ID:61)	Titanium (Finish ID:79)	Ombre (Finish ID:92)	Brush Chrome (Finish ID:95)

- Custom finishes cannot be returned or refunded. We are unable to accept cancellations for custom finish order unless within 48 hours of the order being placed.
- We have uniform pricing for all non-hammered finishes listed above as long as base material and size is same.
- Contact us for customized finishes, refer pages F1, F2, F3 & F4 for finish glossary.
- Backplate options refer page KBP1-1 to KBP14-1.



Polished Nickel (Finish ID:8)

JAZZ T KNOB

“The juxtaposition of two surfaces where knurled meets smooth. The contrast highlights the detail.”

	Item Code	Size (mm & Inches)	Material	Size (Inches)				Fig.
				A	B	C	D	
1	TKNB.836.55.XX	55mm (2.17)	Brass	1.65	0.47	0.87	2.13	1
2	TKNB.836.90.XX	90mm (3.54)	Brass	1.65	0.47	0.87	3.54	1

“XX” in item code denotes Finish ID.

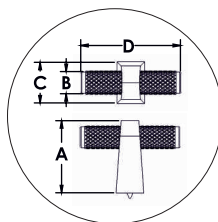

FIG. 1



























This product is Supplied with M4x45mm break off screws.

How to Order

TKNB.836.55.8

T KNOB STYLE : JAZZ SIZE DIAMETER : 55 MM FINISH ID : 8

Jazz T Knob Finish Options

Base Material : Brass			Standard Finishes (2-3 Weeks Delivery)			
						
Bright Chrome (Finish ID:2)	Brush Nickel (Finish ID:3)	Aged Brass (Finish ID:4)	Oil Rubbed Bronze (Finish ID:5)	Unlacquered Polished Brass (Finish ID:7U)	Polished Nickel (Finish ID:8)	Satin Brass (Finish ID:13)
Base Material : Brass			Custom Finishes (3-4 Weeks Delivery)*			
						
Lacquered Polished Brass (Finish ID:7L)	Antique Copper (Finish ID:15)	Matte Black (Finish ID:19)	Split Black and Polished Nickel (Finish ID:48)	Split Black and Satin Brass (Finish ID:49)	Split Satin Brass and White (Finish ID:50)	English Metallic Bronze (Finish ID:51)
						
Split Polished Brass And Oil Rubbed Bronze (Finish ID:57)	Split Black And Chrome (Finish ID:59)	Split Satin Copper And Oil Rubbed Bronze (Finish ID:60)	Graphite (Finish ID:61)	Split Aged Brass And English Metallic Bronze (Finish ID:75)	Split Polished Nickel And Satin Brass (Finish ID:77)	Titanium (Finish ID:79)
						
Split Brush Nickel and Satin Brass (Finish ID:78)	Split Oil Rubbed Bronze and Satin Brass (Finish ID:80)	Split Graphite and Satin Brass (Finish ID:90)	Split Graphite and Brush Chrome (Finish ID:91)	Ombre (Finish ID:92)	Brush Chrome (Finish ID:95)	

- Custom finishes cannot be returned or refunded. We are unable to accept cancellations for custom finish order unless within 48 hours of the order being placed.
- We have uniform pricing for all non-hammered finishes listed above as long as base material and size is same.
- Contact us for customized finishes, refer pages F1, F2, F3 & F4 for finish glossary.
- Backplate options refer page KBP1-1 to KBP14-1.

Jazz T Knob Split Finish

TKNB.836.XX.XX

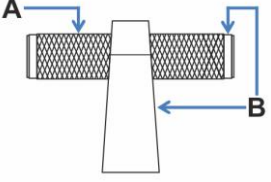
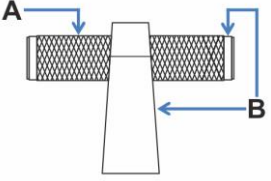
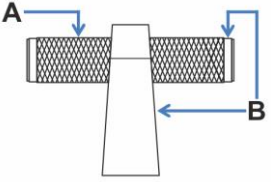
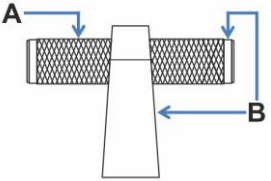
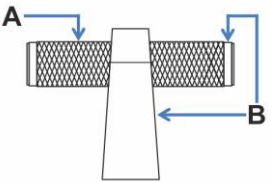
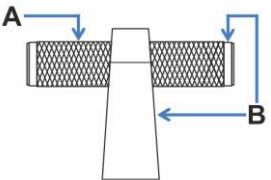
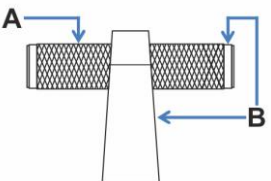
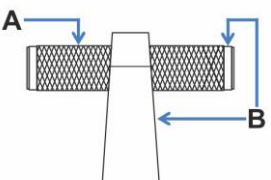
FINISH CODE (XX)	FINISH NAME	LINE DRAWING	A	B
TKNB.836.XX.48	Split Black and Polished Nickel		Matte Black	Polished Nickel
TKNB.836.XX.49	Split Black and Satin Brass		Matte Black	Satin Brass
TKNB.836.XX.50	Split Satin Brass and White		White Epoxy	Satin Brass
TKNB.836.XX.57	Split Polished Brass and Oil Rubbed Bronze		Oil Rubbed Bronze	Lacquered Polished Brass
TKNB.836.XX.59	Split Black and Chrome		Matte Black	Bright Chrome
TKNB.836.XX.60	Split Satin Copper and Oil Rubbed Bronze		Oil Rubbed Bronze	Satin Copper
TKNB.836.XX.75	Split Aged Brass and English Metallic Bronze		English Metallic Bronze	Aged Brass
TKNB.836.XX.77	Split Polished Nickel and Satin Brass		Satin Brass	Polished Nickel

Jazz T Knob Split Finish

TKNB.836.XX.XX

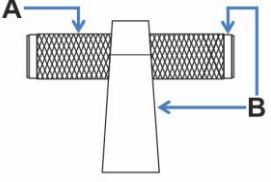
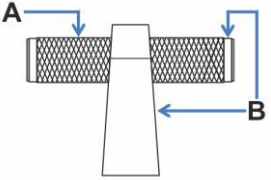
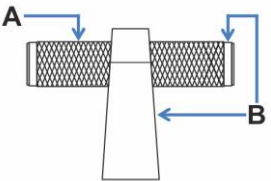
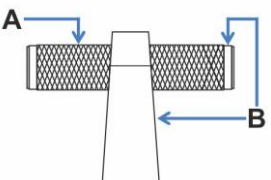
FINISH CODE (XX)	FINISH NAME	LINE DRAWING	A	B
TKNB.836.XX.78	Split Brush Nickel and Satin Brass		Satin Brass	Brush Nickel
TKNB.836.XX.80	Split Oil Rubbed Bronze and Satin Brass		Oil Rubbed Bronze	Satin Brass
TKNB.836.XX.90	Split Graphite and Satin Brass		Graphite	Satin Brass
TKNB.836.XX.91	Split Graphite and Brush Chrome		Graphite	Brush Chrome



Brush Nickel (Finish ID : 3)

RECEDE KNOB

Item Code	Size (mm & Inches)	Material	Size (Inches)				Fig.
			A	B	C	D	
1 KNB.840.38.XX	38mm (1.5")	Brass	1.91	1.5	1.85	N/A	1

"XX" in item code denotes Finish ID.

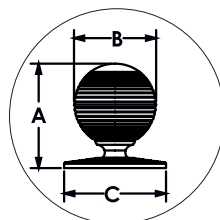

FIG. 1

























This product is Supplied with M4x45mm break off screws.

How to Order

KNB.840.38.3

KNOB STYLE : RECEDE SIZE DIAMETER : 38 MM FINISH ID : 3

Recede Knob Finish Options

Base Material : Brass	Standard Finishes (2-3 Weeks Delivery)						
							
	Bright Chrome (Finish ID:2)	Brush Nickel (Finish ID:3)	Aged Brass (Finish ID:4)	Oil Rubbed Bronze (Finish ID:5)	Unlacquered Polished Brass (Finish ID:7U)	Polished Nickel (Finish ID:8)	Satin Brass (Finish ID:13)
Base Material : Brass	Custom Finishes (3-4 Weeks Delivery)*						
							
	Lacquered Polished Brass (Finish ID:7L)	Antique Copper (Finish ID:15)	Matte Black (Finish ID:19)	Split Black and Polished Nickel (Finish ID:48)	Split Black and Satin Brass (Finish ID:49)	Split Satin Brass and White (Finish ID:50)	Split Polished Brass And Oil Rubbed Bronze (Finish ID:57)
							
	Split Black And Chrome (Finish ID:59)	Split Satin Copper And Oil Rubbed Bronze (Finish ID:60)	Split Aged Brass And English Metallic Bronze (Finish ID:75)	Split Polished Nickel And Satin Brass (Finish ID:77)	Split Brush Nickel and Satin Brass (Finish ID:78)	Split Oil Rubbed Bronze and Satin Brass (Finish ID:80)	Split Graphite and Satin Brass (Finish ID:90)
							
	Split Graphite and Brush Chrome (Finish ID:91)	Ombre (Finish ID:92)	Brush Chrome (Finish ID:95)				

- Custom finishes cannot be returned or refunded. We are unable to accept cancellations for custom finish order unless within 48 hours of the order being placed.
- We have uniform pricing for all non-hammered finishes listed above as long as base material and size is same.
- Contact us for customized finishes, refer pages F1, F2, F3 & F4 for finish glossary.
- Backplate options refer page KBP1-1 to KBP14-1.

Recede Knob Split Finish

KNB.840.XX.XX

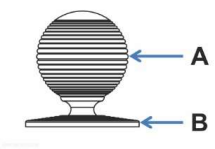
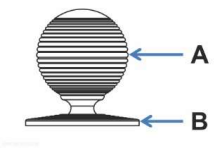
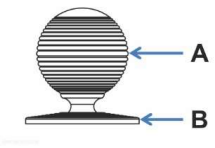
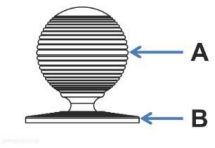
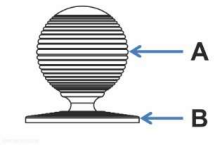
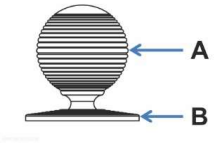
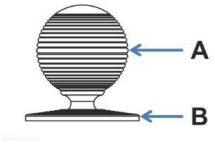
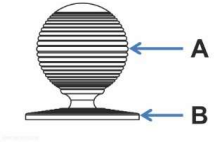
FINISH CODE (XX)	FINISH NAME	LINE DRAWING	A	B
KNB.840.XX.48	Split Black and Polished Nickel		Matte Black	Polished Nickel
KNB.840.XX.49	Split Black and Satin Brass		Matte Black	Satin Brass
KNB.840.XX.50	Split Satin Brass and White		White Epoxy	Satin Brass
KNB.840.XX.57	Split Polished Brass and Oil Rubbed Bronze		Oil Rubbed Bronze	Lacquered Polished Brass
KNB.840.XX.59	Split Black and Chrome		Matte Black	Bright Chrome
KNB.840.XX.60	Split Satin Copper and Oil Rubbed Bronze		Oil Rubbed Bronze	Satin Copper
KNB.840.XX.75	Split Aged Brass and English Metallic Bronze		English Metallic Bronze	Aged Brass
KNB.840.XX.77	Split Polished Nickel and Satin Brass		Satin Brass	Polished Nickel

Recede Knob Split Finish

KNB.840.XX.XX

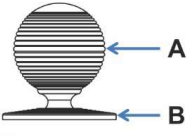
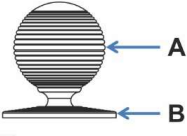
FINISH CODE (XX)	FINISH NAME	LINE DRAWING	A	B
KNB.613.XX.78	Split Brush Nickel and Satin Brass		Brush Nickel	Satin Brass
KNB.840.XX.80	Split Oil Rubbed Bronze and Satin Brass		Oil Rubbed Bronze	Satin Brass
KNB.840.XX.90	Split Graphite and Satin Brass		Graphite	Satin Brass
KNB.840.XX.91	Split Graphite and Brush Chrome		Graphite	Brush Chrome



Split Black and Chrome with Chrome Back Plate (Finish ID : 59A)

JAZZ KNOB WITH BACK PLATE

“The juxtaposition of two surfaces where knurled meets smooth.
The contrast highlights the detail.”

	Item Code	Size (mm & Inches)	Material	Size (Inches)				Fig.
				A	B	C	D	
1	KNB.841.26.XX	26mm (1.02")	Brass	1.38	1.02	3.74	N/A	1
2	KNB.841.30.XX	30mm (1.18")	Brass	1.54	1.18	3.74	N/A	1

“XX” in item code denotes Finish ID.

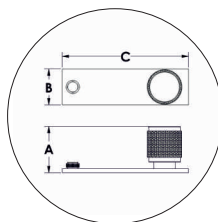

FIG. 1





























This product is Supplied with M4x45mm break off screws.

How to Order

KNB.841.26.59A

KNOB STYLE : JAZZ WITH BACK PLATE SIZE DIAMETER : 26 MM FINISH ID : 59A

Jazz Knob With Back Plate Finish Options

Base Material : Brass				Standard Finishes (2-3 Weeks Delivery)		
						
Bright Chrome (Finish ID:2)	Brush Nickel (Finish ID:3)	Aged Brass (Finish ID:4)	Oil Rubbed Bronze (Finish ID:5)	Unlacquered Polished Brass (Finish ID:7U)	Polished Nickel (Finish ID:8)	Satin Brass (Finish ID:13)
Base Material : Brass				Custom Finishes (3-4 Weeks Delivery)*		
						
Lacquered Polished Brass (Finish ID:7L)	Antique Copper (Finish ID:15)	Matte Black (Finish ID:19)	Split Black and Polished Nickel with Polished Nickel Back Plate (Finish ID:48A)	Split Black and Polished Nickel with Black Back Plate (Finish ID:48B)	Split Black and Satin Brass with Satin Brass Back Plate (Finish ID:49A)	Split Black and Satin Brass with Black Back Plate (Finish ID:49B)
						
Split Satin Brass and White with Satin Brass Back Plate (Finish ID:50A)	Split Satin Brass and White with White Back Plate (Finish ID:50B)	English Metallic Bronze (Finish ID:51)	Split Polished Brass and Oil Rubbed Bronze with Polished Brass Back Plate (Finish ID:57A)	Split Polished Brass and Oil Rubbed Bronze with Oil Rubbed Bronze Back Plate (Finish ID:57B)	Satin Copper (Finish ID:58)	Split Black and Chrome with Chrome Back Plate (Finish ID:59A)
						
Split Black and Chrome with Black Back Plate (Finish ID:59B)	Split Satin Copper and Oil Rubbed Bronze with Satin Copper Back Plate (Finish ID:60A)	Split Satin Copper and Oil Rubbed Bronze with Oil Rubbed Bronze Back Plate (Finish ID:60B)	Graphite (Finish ID:61)	Split Aged Brass and English Metallic Bronze with Aged Brass Back Plate (Finish ID:75A)	Split Aged Brass and English Metallic Bronze with English Metallic Bronze Back Plate (Finish ID:75B)	Split Polished Nickel and Satin Brass with Satin Brass Back Plate (Finish ID:77A)

- Custom finishes cannot be returned or refunded. We are unable to accept cancellations for custom finish order unless within 48 hours of the order being placed.
- We have uniform pricing for all non-hammered finishes listed above as long as base material and size is same.
- Contact us for customized finishes, refer pages F1, F2, F3 & F4 for finish glossary.
- Backplate options refer page KBP1-1 to KBP14-1.

Base Material : Brass		Custom Finishes (3-4 Weeks Delivery)*				
						
Split Polished Nickel and Satin Brass with Polished Nickel Back Plate (Finish ID:77B)	Split Brush Nickel and Satin Brass with Satin Brass Back Plate (Finish ID:78A)	Split Brush Nickel and Satin Brass with Brush Nickel Back Plate (Finish ID:78B)	Titanium (Finish ID:79)	Split Oil Rubbed Bronze And Satin Brass with Satin Brass Back Plate (Finish ID:80A)	Split Oil Rubbed Bronze And Satin Brass with Oil Rubbed Bronze Back Plate (Finish ID:80B)	Split Graphite and Satin Brass with Satin Brass Back Plate (Finish ID:90A)
						
Split Graphite and Satin Brass with Graphite Back Plate (Finish ID:90B)	Split Graphite and Brush Chrome with Graphite Back Plate (Finish ID:91A)	Split Graphite and Brush Chrome with Brush Chrome Back Plate (Finish ID:91B)	Ombre (Finish ID:92)	Brush Chrome (Finish ID:95)		

- Custom finishes cannot be returned or refunded. We are unable to accept cancellations for custom finish order unless within 48 hours of the order being placed.
- We have uniform pricing for all non-hammered finishes listed above as long as base material and size is same.
- Contact us for customized finishes, refer pages F1, F2, F3 & F4 for finish glossary.
- Backplate options refer page KBP1-1 to KBP14-1.

Jazz knob With Back Plate Split Finish

KNB.841.XX.XX

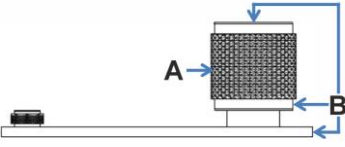
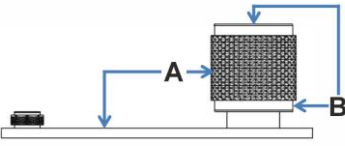
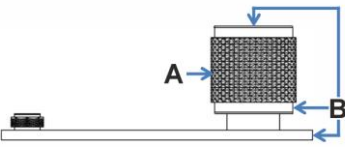
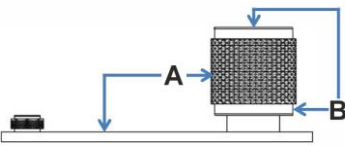
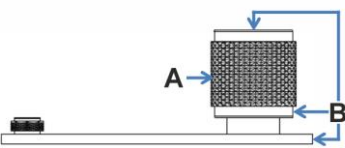
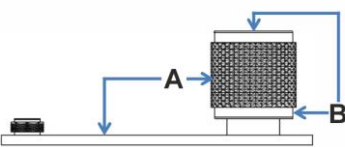
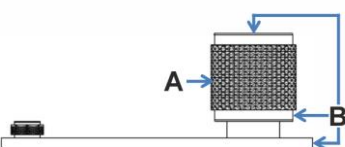
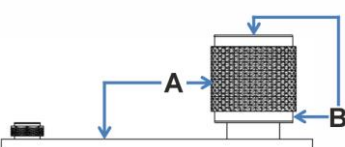
FINISH CODE (XX)	FINISH NAME	LINE DRAWING	A	B
KNB.841.XX.48A	Split Black and Nickel with Polished Nickel Back Plate		Matte Black	Polished Nickel
KNB.841.XX.48B	Split Black and Nickel with Black Back Plate		Matte Black	Polished Nickel
KNB.841.XX.49A	Split Black and Satin Brass with Satin Brass Back Plate		Matte Black	Satin Brass
KNB.841.XX.49B	Split Black and Satin Brass with Black Back Plate		Matte Black	Satin Brass
KNB.841.XX.50A	Split Satin Brass and White with Satin Brass Back Plate		White Epoxy	Satin Brass
KNB.841.XX.50B	Split Satin Brass and White with White Back Plate		White Epoxy	Satin Brass
KNB.841.XX.57A	Split Lacquered Polished Brass and Oil Rubbed Bronze with Lacquered Polished Brass Back Plate		Oil Rubbed Bronze	Lacquered Polished Brass
KNB.841.XX.57B	Split Lacquered Polished Brass and Oil Rubbed Bronze with Oil Rubbed Bronze Back Plate		Oil Rubbed Bronze	Lacquered Polished Brass

Jazz knob With Back Plate Split Finish

KNB.841.XX.XX

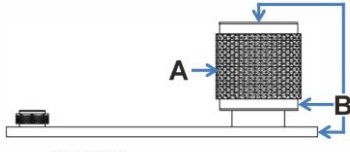
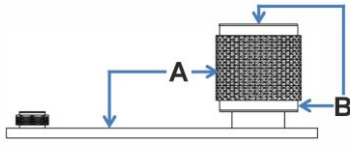
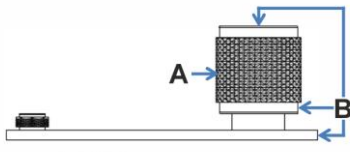
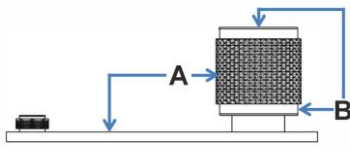
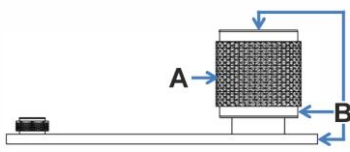
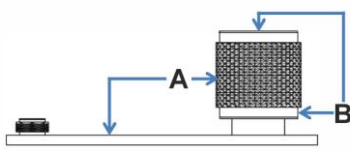
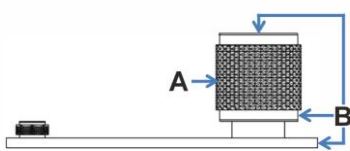
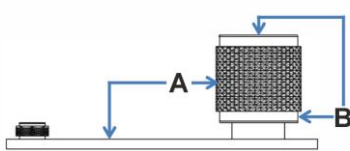
FINISH CODE (XX)	FINISH NAME	LINE DRAWING	A	B
KNB.841.XX.59A	Split Black and chrome with chrome back plate		Matte Black	Bright Chrome
KNB.841.XX.59B	Split Black and chrome / Black back plate		Matte Black	Bright Chrome
KNB.841.XX.60A	Split Satin Copper and Oil Rubbed Bronze with Satin Copper Back Plate		Oil Rubbed Bronze	Satin Copper
KNB.841.XX.60B	Split Satin Copper and Oil Rubbed Bronze with Oil Rubbed Bronze Back Plate		Oil Rubbed Bronze	Satin Copper
KNB.841.XX.75A	Split Aged Brass and English Metallic Bronze with Aged Brass Back Plate		English Metallic Bronze	Aged Brass
KNB.841.XX.75B	Split Aged Brass and English Metallic Bronze with English Metallic Bronze Back Plate		English Metallic Bronze	Aged Brass
KNB.841.XX.77A	Split Polished Nickel and Satin Brass with Satin Brass Back Plate		Satin Brass	Polished Nickel
KNB.841.XX.77B	Split Polished Nickel and Satin Brass with Polished Nickel Back Plate		Satin Brass	Polished Nickel

Jazz knob With Back Plate Split Finish

KNB.841.XX.XX

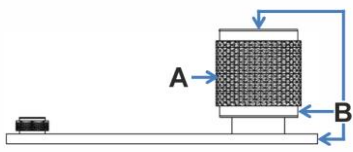
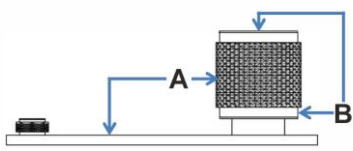
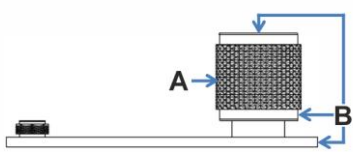
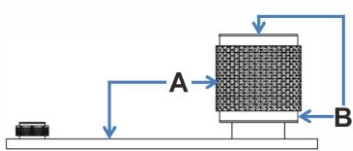
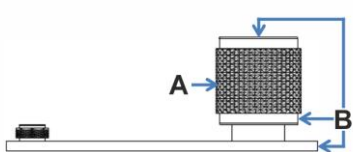
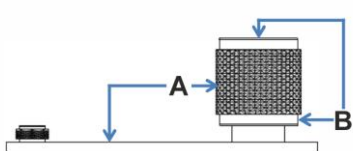
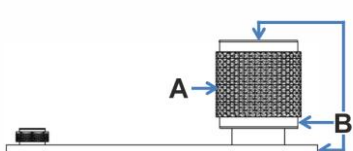
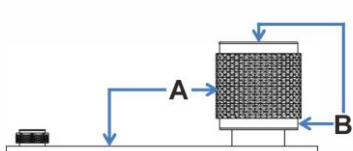
FINISH CODE (XX)	FINISH NAME	LINE DRAWING	A	B
KNB.841.XX.78A	Split Brush Nickel and Satin Brass with Satin Brass Back Plate		Satin Brass	Brush Nickel
KNB.841.XX.78B	Split Brush Nickel and Satin Brass with Brush Nickel Back Plate		Satin Brass	Brush Nickel
KNB.841.XX.80A	Split Oil Rubbed Bronze and Satin Brass with Satin Brass Back Plate		Oil Rubbed Bronze	Satin Brass
KNB.841.XX.80B	Split Oil Rubbed Bronze and Satin Brass with Oil Rubbed Bronze Back Plate		Oil Rubbed Bronze	Satin Brass
KNB.841.XX.90A	Split Graphite and Satin Brass with Satin Brass Back Plate		Graphite	Satin Brass
KNB.841.XX.90B	Split Graphite and Satin Brass with Graphite Back Plate		Graphite	Satin Brass
KNB.841.XX.91A	Split Graphite and Brush Chrome with Brush Chrome Back Plate		Graphite	Brush Chrome
KNB.841.XX.91B	Split Graphite and Brush Chrome with Graphite Back Plate		Graphite	Brush Chrome

M Y O H
MAKE YOUR OWN HOME

fac



Split Black and Satin Brass with Satin Brass Back Plate (Finish ID : 49A)

JAZZ T KNOB WITH BACK PLATE

“The juxtaposition of two surfaces where knurled meets smooth.
The contrast highlights the detail.”

	Item Code	Size (mm & Inches)	Material	Size (Inches)				Fig.
				A	B	C	D	
1	TKNB.841.55.XX	55mm (2.17")	Brass	1.65	2.32	1.02	0.5	1
2	TKNB.841.90.XX	90mm (3.54")	Brass	1.65	3.74	1.02	0.5	1

“XX” in item code denotes Finish ID.

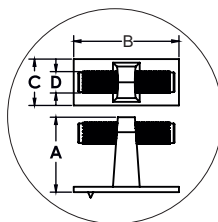

FIG. 1





























This product is Supplied with M4x45mm break off screws.

How to Order

KNB.841.26.49A

KNOB STYLE : JAZZ WITH BACK PLATE SIZE DIAMETER : 26 MM FINISH ID : 49A

Jazz Knob With Back Plate Finish Options

Base Material : Brass				Standard Finishes (2-3 Weeks Delivery)		
						
Bright Chrome (Finish ID:2)	Brush Nickel (Finish ID:3)	Aged Brass (Finish ID:4)	Oil Rubbed Bronze (Finish ID:5)	Unlacquered Polished Brass (Finish ID:7U)	Polished Nickel (Finish ID:8)	Satin Brass (Finish ID:13)
Base Material : Brass				Custom Finishes (3-4 Weeks Delivery)*		
						
Lacquered Polished Brass (Finish ID:7L)	Antique Copper (Finish ID:15)	Matte Black (Finish ID:19)	Split Black and Polished Nickel with Polished Nickel Back Plate (Finish ID:48A)	Split Black and Polished Nickel with Black Back Plate (Finish ID:48B)	Split Black and Satin Brass with Satin Brass Back Plate (Finish ID:49A)	Split Black and Satin Brass with Black Back Plate (Finish ID:49B)
						
Split Satin Brass and White with Satin Brass Back Plate (Finish ID:50A)	Split Satin Brass and White with White Back Plate (Finish ID:50B)	English Metallic Bronze (Finish ID:51)	Split Polished Brass and Oil Rubbed Bronze with Polished Brass Back Plate (Finish ID:57A)	Split Polished Brass and Oil Rubbed Bronze with Oil Rubbed Bronze Back Plate (Finish ID:57B)	Satin Copper (Finish ID:58)	Split Black and Chrome with Chrome Back Plate (Finish ID:59A)
						
Split Black and Chrome with Black Back Plate (Finish ID:59B)	Split Satin Copper and Oil Rubbed Bronze with Satin Copper Back Plate (Finish ID:60A)	Split Satin Copper and Oil Rubbed Bronze with Oil Rubbed Bronze Back Plate (Finish ID:60B)	Graphite (Finish ID:61)	Split Aged Brass and English Metallic Bronze with Aged Brass Back Plate (Finish ID:75A)	Split Aged Brass and English Metallic Bronze with English Metallic Bronze Back Plate (Finish ID:75B)	Split Polished Nickel and Satin Brass with Satin Brass Back Plate (Finish ID:77A)

- Custom finishes cannot be returned or refunded. We are unable to accept cancellations for custom finish order unless within 48 hours of the order being placed.
- We have uniform pricing for all non-hammered finishes listed above as long as base material and size is same.
- Contact us for customized finishes, refer pages F1, F2, F3 & F4 for finish glossary.
- Backplate options refer page KBP1-1 to KBP14-1.

Base Material : Brass		Custom Finishes (3-4 Weeks Delivery)*				
						
Split Polished Nickel and Satin Brass with Polished Nickel Back Plate (Finish ID:77B)	Split Brush Nickel and Satin Brass with Satin Brass Back Plate (Finish ID:78A)	Split Brush Nickel and Satin Brass with Brush Nickel Back Plate (Finish ID:78B)	Titanium (Finish ID:79)	Split Oil Rubbed Bronze And Satin Brass with Satin Brass Back Plate (Finish ID:80A)	Split Oil Rubbed Bronze And Satin Brass with Oil Rubbed Bronze Back Plate (Finish ID:80B)	Split Graphite and Satin Brass with Satin Brass Back Plate (Finish ID:90A)
						
Split Graphite and Satin Brass with Graphite Back Plate (Finish ID:90B)	Split Graphite and Brush Chrome with Graphite Back Plate (Finish ID:91A)	Split Graphite and Brush Chrome with Brush Chrome Back Plate (Finish ID:91B)	Ombre (Finish ID:92)	Brush Chrome (Finish ID:95)		

- Custom finishes cannot be returned or refunded. We are unable to accept cancellations for custom finish order unless within 48 hours of the order being placed.
- We have uniform pricing for all non-hammered finishes listed above as long as base material and size is same.
- Contact us for customized finishes, refer pages F1, F2, F3 & F4 for finish glossary.
- Backplate options refer page KBP1-1 to KBP14-1.

Jazz T knob With Back Plate Split Finish

TKNB.841.XX.XX

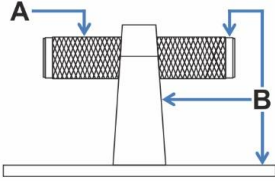
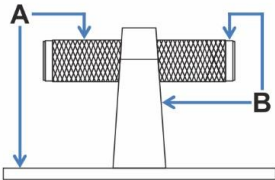
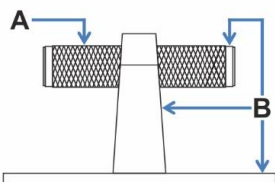
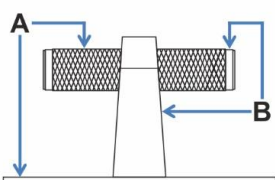
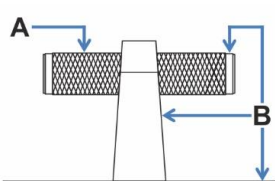
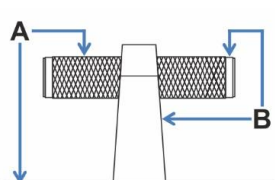
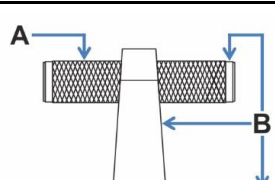
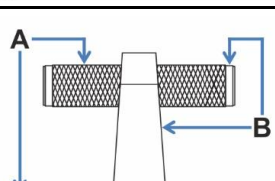
FINISH CODE (XX)	FINISH NAME	LINE DRAWING	A	B
TKNB.841.XX.48A	Split Black and Nickel with Polished Nickel Back Plate		Matte Black	Polished Nickel
TKNB.841.XX.48B	Split Black and Nickel with Black Back Plate		Matte Black	Polished Nickel
TKNB.841.XX.49A	Split Black and Satin Brass with Satin Brass Back Plate		Matte Black	Satin Brass
TKNB.841.XX.49B	Split Black and Satin Brass with Black Back Plate		Matte Black	Satin Brass
TKNB.841.XX.50A	Split Satin Brass and White with Satin Brass Back Plate		White Epoxy	Satin Brass
TKNB.841.XX.50B	Split Satin Brass and White with White Back Plate		White Epoxy	Satin Brass
TKNB.841.XX.57A	Split Lacquered Polished Brass and Oil Rubbed Bronze with Lacquered Polished Brass Back Plate		Oil Rubbed Bronze	Lacquered Polished Brass
TKNB.841.XX.57B	Split Lacquered Polished Brass and Oil Rubbed Bronze with Oil Rubbed Bronze Back Plate		Oil Rubbed Bronze	Lacquered Polished Brass

Jazz T knob With Back Plate Split Finish

TKNB.841.XX.XX

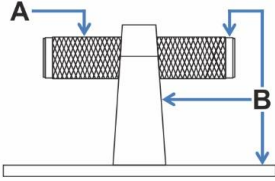
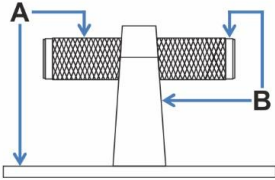
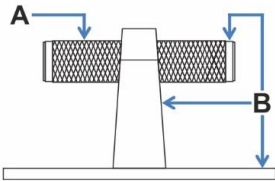
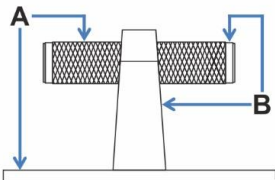
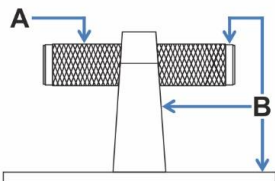
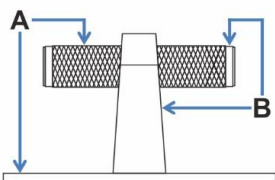
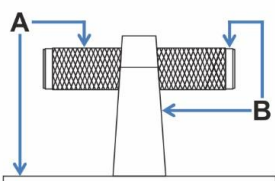
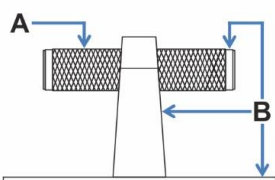
FINISH CODE (XX)	FINISH NAME	LINE DRAWING	A	B
TKNB.841.XX.59A	Split Black and chrome with chrome back plate		Matte Black	Bright Chrome
TKNB.841.XX.59B	Split Black and chrome / Black back plate		Matte Black	Bright Chrome
TKNB.841.XX.60A	Split Satin Copper and Oil Rubbed Bronze with Satin Copper Back Plate		Oil Rubbed Bronze	Satin Copper
TKNB.841.XX.60B	Split Satin Copper and Oil Rubbed Bronze with Oil Rubbed Bronze Back Plate		Oil Rubbed Bronze	Satin Copper
TKNB.841.XX.75A	Split Aged Brass and English Metallic Bronze with Aged Brass Back Plate		English Metallic Bronze	Aged Brass
TKNB.841.XX.75B	Split Aged Brass and English Metallic Bronze with English Metallic Bronze Back Plate		English Metallic Bronze	Aged Brass
TKNB.841.XX.77A	Split Polished Nickel and Satin Brass with Satin Brass Back Plate		Satin Brass	Polished Nickel
TKNB.841.XX.77B	Split Polished Nickel and Satin Brass with Polished Nickel Back Plate		Satin Brass	Polished Nickel

Jazz T knob With Back Plate Split Finish

TKNB.841.XX.XX

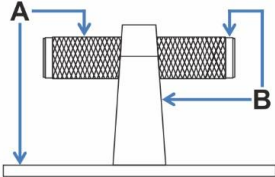
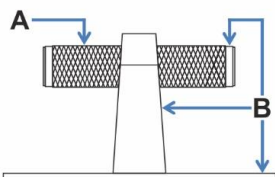
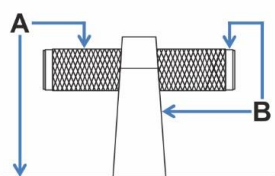
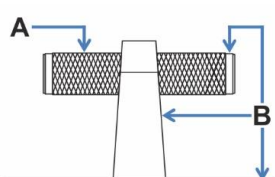
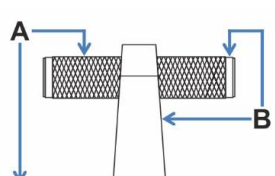
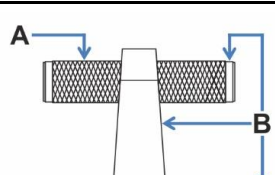
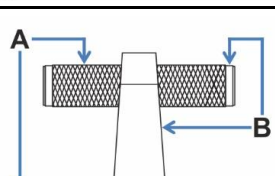
FINISH CODE (XX)	FINISH NAME	LINE DRAWING	A	B
TKNB.841.XX.78A	Split Brush Nickel and Satin Brass with Satin Brass Back Plate		Satin Brass	Brush Nickel
TKNB.841.XX.78B	Split Brush Nickel and Satin Brass with Brush Nickel Back Plate		Satin Brass	Brush Nickel
TKNB.841.XX.80A	Split Oil Rubbed Bronze and Satin Brass with Satin Brass Back Plate		Oil Rubbed Bronze	Satin Brass
TKNB.841.XX.80B	Split Oil Rubbed Bronze and Satin Brass with Oil Rubbed Bronze Back Plate		Oil Rubbed Bronze	Satin Brass
TKNB.841.XX.90A	Split Graphite and Satin Brass with Satin Brass Back Plate		Graphite	Satin Brass
TKNB.841.XX.90B	Split Graphite and Satin Brass with Graphite Back Plate		Graphite	Satin Brass
TKNB.841.XX.91A	Split Graphite and Brush Chrome with Brush Chrome Back Plate		Graphite	Brush Chrome
TKNB.841.XX.91B	Split Graphite and Brush Chrome with Graphite Back Plate		Graphite	Brush Chrome

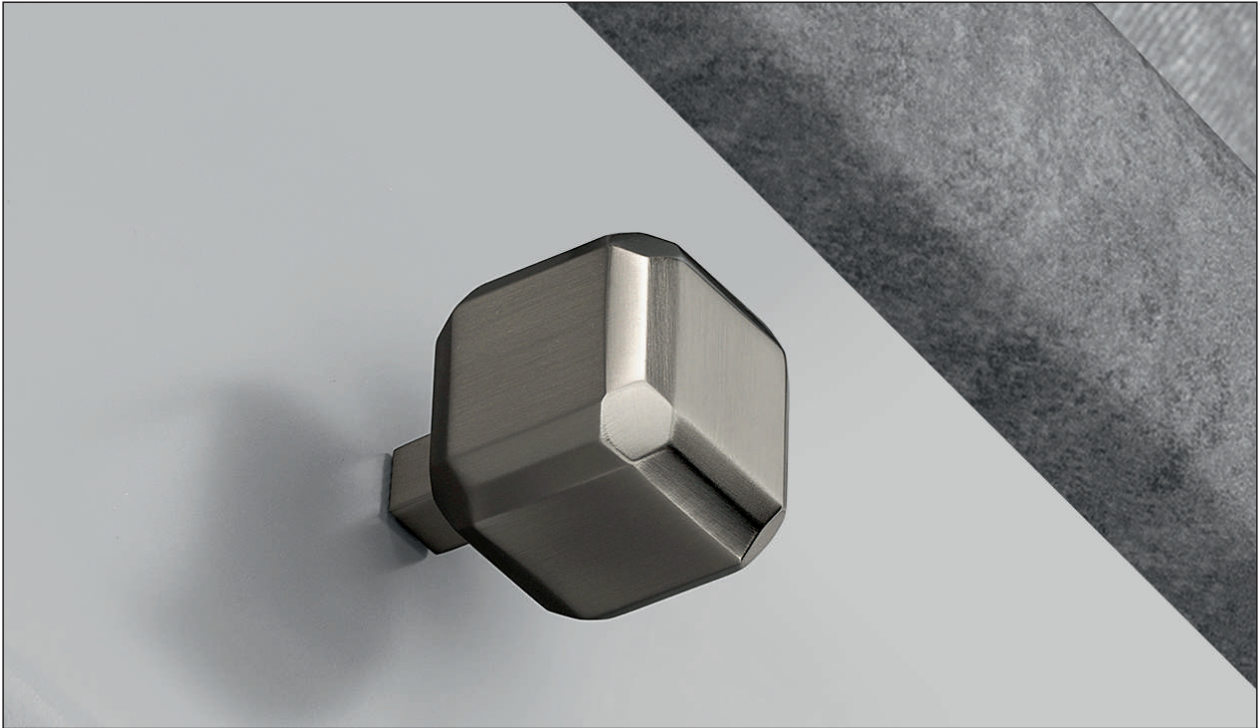

Brush Nickel (Finish ID : 3)

WRIGHT PERLA KNOB WITHOUT BACK PLATE

“The Taj Mahal is a universally revered architectural masterpiece of world heritage, the bevelled geometric shape of the base of the Taj is the inspiration behind Wright Perla.”

	Item Code	Size (mm & Inches)	Material	Size (Inches)				Fig.
				A	B	C	D	
1	KNB.850.25.XX	25mm (0.98")	Brass	1.38	0.98	0.98	N/A	1
2	KNB.850.30.XX	30mm (1.18")	Brass	1.57	1.18	1.18	N/A	1

“XX” in item code denotes Finish ID.

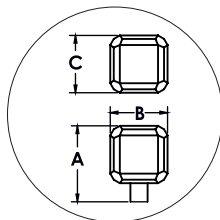

FIG. 1

This product is Supplied with M4x25mm screws.
This product is Supplied with M4x45mm break off screws.

How to Order

KNB.850.25.3

KNOB STYLE : WRIGHT PERLA SIZE DIAMETER : 25 MM FINISH ID : 3

Wright Perla Knob Without Back Plate Finish Options

Base Material : Brass		Standard Finishes (2-3 Weeks Delivery)				
						
Bright Chrome (Finish ID:2)	Brush Nickel (Finish ID:3)	Aged Brass (Finish ID:4)	Oil Rubbed Bronze (Finish ID:5)	Unlacquered Polished Brass (Finish ID:7U)	Polished Nickel (Finish ID:8)	Satin Brass (Finish ID:13)
Base Material : Brass		Custom Finishes (3-4 Weeks Delivery)*				
						
Lacquered Polished Brass (Finish ID:7L)	Matte Black (Finish ID:19)	English Metallic Bronze (Finish ID:51)	Satin Copper (Finish ID:58)	Graphite (Finish ID:61)	Titanium (Finish ID:79)	Ombre (Finish ID:92)
						
Brush Chrome (Finish ID:95)						

- Custom finishes cannot be returned or refunded. We are unable to accept cancellations for custom finish order unless within 48 hours of the order being placed.
- We have uniform pricing for all non-hammered finishes listed above as long as base material and size is same.
- Contact us for customized finishes, refer pages F1, F2, F3 & F4 for finish glossary.
- Backplate options refer page KBP1-1 to KBP14-1.



Unlacquered Polished Brass (Finish ID : 7U)

CLASSIC KNOB WITH BACK PLATE

“Inspired by the portholes on classic 1930's
Transatlantic ocean liners”

Item Code	Size (mm & Inches)	Material	Size (Inches)				Fig.
			A	B	C	D	
1 KNB.854.28.XX	28 mm (1.10")	Brass	1.26	1.08	1.2	1.81	1

XX" in item code denotes Finish ID.

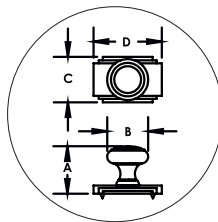

FIG. 1

This product is Supplied with M4x25mm screws.
This product is Supplied with M4x45mm break off screws.

How to Order

KNB.854.28.7U

KNOB STYLE : CLASSIC WITH BACK PLATE SIZE DIAMETER : 28 MM FINISH ID : 7U

Classic Knob With Back Plate Finish Options

Base Material : Brass		Standard Finishes (2-3 Weeks Delivery)			
					
Bright Chrome (Finish ID:2)	Brush Nickel (Finish ID:3)	Aged Brass (Finish ID:4)	Oil Rubbed Bronze (Finish ID:5)	Unlacquered Polished Brass (Finish ID:7U)	Polished Nickel (Finish ID:8)
Base Material : Brass		Custom Finishes (3-4 Weeks Delivery)*			
					
Lacquered Polished Brass (Finish ID:7L)	Ombre (Finish ID:92)	Brush Chrome (Finish ID:95)			

- Custom finishes cannot be returned or refunded. We are unable to accept cancellations for custom finish order unless within 48 hours of the order being placed.
- We have uniform pricing for all non-hammered finishes listed above as long as base material and size is same.
- Contact us for customized finishes, refer pages F1, F2, F3 & F4 for finish glossary.
- Backplate options refer page KBP1-1 to KBP14-1.



Graphite (Finish ID : 61)

HIVE KNOB

	Item Code	Size (mm & Inches)	Material	Size (Inches)				Fig.
				A	B	C	D	
1	KNB.855.32.XX	32mm (1.26")	Brass	1.1	1.26	N/A	N/A	1
2	KNB.855.38.XX	38mm (1.5")	Brass	1.14	1.5	N/A	N/A	1
3	KNB.855.32.XX	32mm (1.26")	Bronze	1.1	1.26	N/A	N/A	1
4	KNB.855.38.XX	38mm (1.5")	Bronze	1.14	1.5	N/A	N/A	1

"XX" in item code denotes Finish ID.

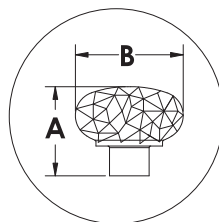

FIG. 1



















This product is Supplied with M4x25mm screws.
This product is Supplied with M4x45mm break off screws.

How to Order

KNB.855.32.61

KNOB STYLE : HIVE SIZE DIAMETER : 32 MM FINISH ID : 61

Hive Knob Finish Options

Base Material : Brass		Standard Finishes (2-3 Weeks Delivery)				
						
Bright Chrome (Finish ID:2)	Brush Nickel (Finish ID:3)	Aged Brass (Finish ID:4)	Oil Rubbed Bronze (Finish ID:5)	Unlacquered Polished Brass (Finish ID:7U)	Polished Nickel (Finish ID:8)	Satin Brass (Finish ID:13)
Base Material : Brass		Custom Finishes (3-4 Weeks Delivery)*				
						
Lacquered Polished Brass (Finish ID:7L)	Antique Copper (Finish ID:15)	Matte Black (Finish ID:19)	Rose Gold (Finish ID:33)	English Metallic Bronze (Finish ID:51)	Satin Copper (Finish ID:58)	Graphite (Finish ID:61)
						
Ombre (Finish ID:92)	Brush Chrome (Finish ID:95)					
Base Material : Bronze		Custom Finishes (3-4 Weeks Delivery)*				
						
Silicon Bronze Light (Finish ID:53)	Silicon Bronze Dark (Finish ID:53D)	White Bronze (Finish ID:54)				

- Custom finishes cannot be returned or refunded. We are unable to accept cancellations for custom finish order unless within 48 hours of the order being placed.
- We have uniform pricing for all non-hammered finishes listed above as long as base material and size is same.
- Contact us for customized finishes, refer pages F1, F2, F3 & F4 for finish glossary.
- Backplate options refer page KBP1-1 to KBP14-1.



English Metallic Bronze (Finish ID : 51)

BROADWAY KNOB

“Walking the length of Broadway through Manhattan, Wall Street and Times Square, architecturally inspired buildings reflect light and colour. We have tried to capture this spirit in the linear design and profile of our Broadway handle.”

Item Code	Size (mm & Inches)	Material	Size (Inches)				Fig.
			A	B	C	D	
1 KNB.856.32.XX	32mm (1.26")	Brass	0.89	1.26	0.75	N/A	1

“XX” in item code denotes Finish ID.

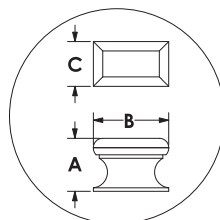

FIG. 1

This product is Supplied with M4x25mm screws.
This product is Supplied with M4x45mm break off screws.

How to Order

KNB.856.32.51

KNOB STYLE : BROADWAY SIZE DIAMETER : 32 MM FINISH ID : 51

Broadway Knob Finish Options

Base Material : Brass		Standard Finishes (2-3 Weeks Delivery)				
						
Bright Chrome (Finish ID:2)	Brush Nickel (Finish ID:3)	Aged Brass (Finish ID:4)	Oil Rubbed Bronze (Finish ID:5)	Unlacquered Polished Brass (Finish ID:7U)	Polished Nickel (Finish ID:8)	Satin Brass (Finish ID:13)
Base Material : Brass		Custom Finishes (3-4 Weeks Delivery)*				
						
Lacquered Polished Brass (Finish ID:7L)	Antique Copper (Finish ID:15)	Matte Black (Finish ID:19)	English Metallic Bronze (Finish ID:51)	Graphite (Finish ID:61)	Titanium (Finish ID:79)	Ombre (Finish ID:92)
						
Brush Chrome (Finish ID:95)						

- Custom finishes cannot be returned or refunded. We are unable to accept cancellations for custom finish order unless within 48 hours of the order being placed.
- We have uniform pricing for all non-hammered finishes listed above as long as base material and size is same.
- Contact us for customized finishes, refer pages F1, F2, F3 & F4 for finish glossary.
- Backplate options refer page KBP1-1 to KBP14-1.



Polished Nickel (Finish ID : 8)

MARELLA KNOB

“Marella with its simple smooth design and concentric grooves could almost be seeking inspiration from the famous Guggenheim Museum in New York.”

	Item Code	Size (mm & Inches)	Material	Size (Inches)				Fig.
				A	B	C	D	
1	KNB.857.28.XX	28mm (1.10")	Brass	1	1.1	0.5	N/A	1
2	KNB.857.32.XX	32mm (1.26")	Brass	1.12	1.26	0.59	N/A	1

"XX" in item code denotes Finish ID.

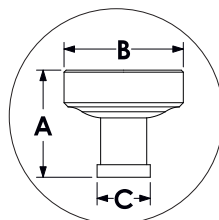

FIG. 1

This product is Supplied with M4x25mm screws.
This product is Supplied with M4x45mm break off screws.

How to Order

KNB.857.28.8

KNOB STYLE : MARELLA SIZE DIAMETER : 28 MM FINISH ID : 8

Marella Knob Finish Options

Base Material : Brass		Standard Finishes (2-3 Weeks Delivery)				
						
Bright Chrome (Finish ID:2)	Brush Nickel (Finish ID:3)	Unlacquered Polished Brass (Finish ID:7U)	Polished Nickel (Finish ID:8)	Satin Brass (Finish ID:13)		
Base Material : Brass		Custom Finishes (3-4 Weeks Delivery)*				
						
Lacquered Polished Brass (Finish ID:7L)	Matte Black (Finish ID:19)	Graphite (Finish ID:61)	Titanium (Finish ID:79)	Ombre (Finish ID:92)	Brush Chrome (Finish ID:95)	

- Custom finishes cannot be returned or refunded. We are unable to accept cancellations for custom finish order unless within 48 hours of the order being placed.
- We have uniform pricing for all non-hammered finishes listed above as long as base material and size is same.
- Contact us for customized finishes, refer pages F1, F2, F3 & F4 for finish glossary.
- Backplate options refer page KBP1-1 to KBP14-1.



Split Black and Satin Brass With Black Back Plate (Finish ID : 49B)

CORNWALL KNOB WITH RECTANGULAR BACK PLATE

“The Classic cupboard knob takes its inspiration from Art Deco clock faces, mirror frames and geometric wall coverings evocative of the 1930's”

Item Code	Size (mm & Inches)	Material	Size (Inches)				Fig.
			A	B	C	D	
1 KNB.858.32.XX.RTB	32mm (1.26")	Brass	1.18	1.26	2.24	1.5	1

“XX” in item code denotes Finish ID.

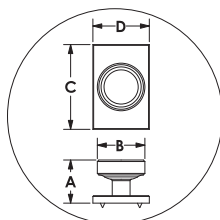
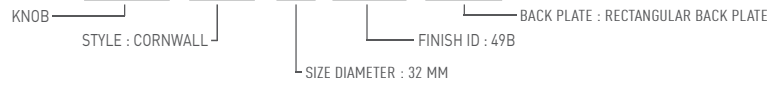

FIG. 1

































This product is Supplied with M4x30mm screws.
This product is Supplied with M4x45mm break off screws.

How to Order

KNB.858.32.49B.RTB



Cornwall Knob With Rectangular Back Plate Finish Options

Base Material : Brass	Standard Finishes (2-3 Weeks Delivery)
 Bright Chrome (Finish ID:2)	 Brush Nickel (Finish ID:3)
 Aged Brass (Finish ID:4)	 Oil Rubbed Bronze (Finish ID:5)
 Polished Nickel (Finish ID:8)	 Satin Brass (Finish ID:13)
Base Material : Brass	Custom Finishes (3-4 Weeks Delivery)*
 Split Black and Polished Nickel with Polished Nickel Back Plate (Finish ID:48A)	 Split Black and Polished Nickel with Black Back Plate (Finish ID:48B)
 Split Black and Satin Brass with Satin Brass Back Plate (Finish ID:49A)	 Split Black and Satin Brass with Black Back Plate (Finish ID:49B)
 Split Satin Brass and White with Satin Brass Back Plate (Finish ID:50A)	 Split Satin Brass and White with White Back Plate (Finish ID:50B)
 English Metallic Bronze (Finish ID:51)	
 Split Polished Brass and Oil Rubbed Bronze with Polished Brass Back Plate (Finish ID:57A)	 Split Polished Brass and Oil Rubbed Bronze with Oil Rubbed Bronze Back Plate (Finish ID:57B)
 Split Black and Chrome with Chrome Back Plate (Finish ID:59A)	 Split Black and Chrome with Black Back Plate (Finish ID:59B)
 Split Satin Copper and Oil Rubbed Bronze with Satin Copper Back Plate (Finish ID:60A)	 Split Satin Copper and Oil Rubbed Bronze with Oil Rubbed Bronze Back Plate (Finish ID:60B)
 Split Aged Brass and English Metallic Bronze with Aged Brass Back Plate (Finish ID:75A)	 Split Aged Brass and English Metallic Bronze with English Metallic Bronze Back Plate (Finish ID:75B)
 Split Polished Nickel and Satin Brass with Satin Brass Back Plate (Finish ID:77A)	 Split Polished Nickel and Satin Brass with Polished Nickel Back Plate (Finish ID:77B)
 Split Brush Nickel and Satin Brass with Satin Brass Back Plate (Finish ID:78A)	 Split Brush Nickel and Satin Brass with Brush Nickel Back Plate (Finish ID:78B)
 Split Oil Rubbed Bronze And Satin Brass with Satin Brass Back Plate (Finish ID:80A)	
 Split Oil Rubbed Bronze And Satin Brass with Oil Rubbed Bronze Back Plate (Finish ID:80B)	 Split Graphite and Satin Brass with Satin Brass Back Plate (Finish ID:90A)
 Split Graphite and Satin Brass with Graphite Back Plate (Finish ID:90B)	 Split Graphite and Brush Chrome with Graphite Back Plate (Finish ID:91A)
 Split Graphite and Brush Chrome with Brush Chrome Back Plate (Finish ID:91B)	 Ombre (Finish ID:92)
 Brush Chrome (Finish ID:95)	

- Custom finishes cannot be returned or refunded. We are unable to accept cancellations for custom finish order unless within 48 hours of the order being placed.
- We have uniform pricing for all non-hammered finishes listed above as long as base material and size is same.
- Contact us for customized finishes, refer pages F1, F2, F3 & F4 for finish glossary.
- Backplate options refer page KBP1-1 to KBP14-1.

Cornwall Knob With Rectangular Back Plate Split Finish

KNB.858.XX.XX.RTB

FINISH CODE (XX)	FINISH NAME	LINE DRAWING	A	B
KNB.858.XX. 48A .RTB	Split Black and Nickel with Polished Nickel Back Plate		Matte Black	Polished Nickel
KNB.858.XX. 48B .RTB	Split Black and Nickel with Black Back Plate		Matte Black	Polished Nickel
KNB.858.XX. 49A .RTB	Split Black and Satin Brass with Satin Brass Back Plate		Matte Black	Satin Brass
KNB.858.XX. 49B .RTB	Split Black and Satin Brass with Black Back Plate		Matte Black	Satin Brass
KNB.858.XX. 50A .RTB	Split Satin Brass and White with Satin Brass Back Plate		White Epoxy	Satin Brass
KNB.858.XX. 50B .RTB	Split Satin Brass and White with White Back Plate		White Epoxy	Satin Brass
KNB.858.XX. 57A .RTB	Split Lacquered Polished Brass and Oil Rubbed Bronze with Lacquered Polished Brass Back Plate		Oil Rubbed Bronze	Lacquered Polished Brass
KNB.858.XX. 57B .RTB	Split Lacquered Polished Brass and Oil Rubbed Bronze with Oil Rubbed Bronze Back Plate		Oil Rubbed Bronze	Lacquered Polished Brass

Cornwall Knob With Rectangular Back Plate Split Finish

KNB.858.XX.XX.RTB

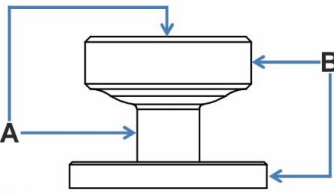
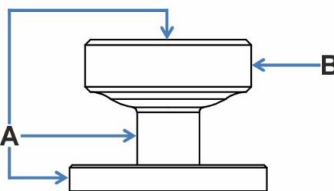
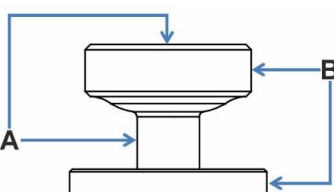
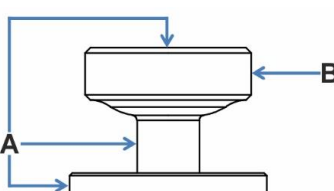
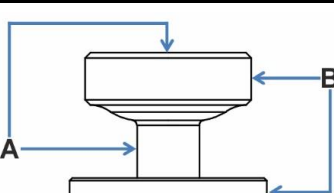
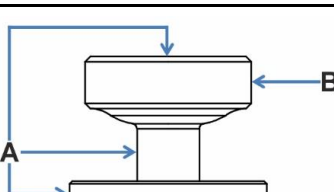
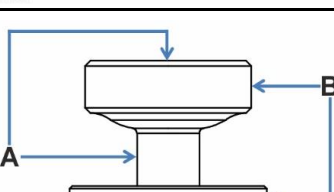
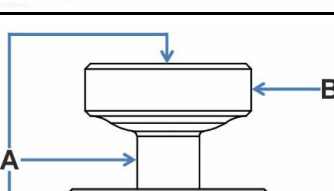
FINISH CODE (XX)	FINISH NAME	LINE DRAWING	A	B
KNB.858.XX.59A.RTB	Split Black and chrome with chrome back plate		Matte Black	Bright Chrome
KNB.858.XX.59B.RTB	Split Black and chrome / Black back plate		Matte Black	Bright Chrome
KNB.858.XX.60A.RTB	Split Satin Copper and Oil Rubbed Bronze with Satin Copper Back Plate		Oil Rubbed Bronze	Satin Copper
KNB.858.XX.60B.RTB	Split Satin Copper and Oil Rubbed Bronze with Oil Rubbed Bronze Back Plate		Oil Rubbed Bronze	Satin Copper
KNB.858.XX.75A.RTB	Split Aged Brass and English Metallic Bronze with Aged Brass Back Plate		English Metallic Bronze	Aged Brass
KNB.858.XX.75B.RTB	Split Aged Brass and English Metallic Bronze with English Metallic Bronze Back Plate		English Metallic Bronze	Aged Brass
KNB.858.XX.77A.RTB	Split Polished Nickel and Satin Brass with Satin Brass Back Plate		Polished Nickel	Satin Brass
KNB.858.XX.77B.RTB	Split Polished Nickel and Satin Brass with Polished Nickel Back Plate		Polished Nickel	Satin Brass

Cornwall Knob With Rectangular Back Plate Split Finish

KNB.858.XX.XX.RTB

FINISH CODE (XX)	FINISH NAME	LINE DRAWING	A	B
KNB.858.XX.78A.RTB	Split Brush Nickel and Satin Brass with Satin Brass Back Plate		Brush Nickel	Satin Brass
KNB.858.XX.78B.RTB	Split Brush Nickel and Satin Brass with Brush Nickel Back Plate		Brush Nickel	Satin Brass
KNB.858.XX.80A.RTB	Split Oil Rubbed Bronze and Satin Brass with Satin Brass Back Plate		Oil Rubbed Bronze	Satin Brass
KNB.858.XX.80B.RTB	Split Oil Rubbed Bronze and Satin Brass with Oil Rubbed Bronze Back Plate		Oil Rubbed Bronze	Satin Brass
KNB.858.XX.90A.RTB	Split Graphite and Satin Brass with Satin Brass Back Plate		Graphite	Satin Brass
KNB.858.XX.90B.RTB	Split Graphite and Satin Brass with Graphite Back Plate		Graphite	Satin Brass
KNB.858.XX.91A.RTB	Split Graphite and Brush Chrome with Brush Chrome Back Plate		Graphite	Brush Chrome
KNB.858.XX.91B.RTB	Split Graphite and Brush Chrome with Graphite Back Plate		Graphite	Brush Chrome



Bright Chrome (Finish ID : 2)

CORNWALL KNOB WITH SQUARE BACK PLATE

“The Classic cupboard knob takes its inspiration from Art Deco clock faces, mirror frames and geometric wall coverings evocative of the 1930's”

Item Code	Size (mm & Inches)	Material	Size (Inches)				Fig.
			A	B	C	D	
1 KNB.858.32.XX.SQB	32mm (1.26")	Brass	1.18	1.26	1.5	1.5	1

“XX” in item code denotes Finish ID.

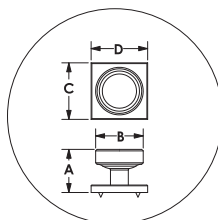

FIG. 1



































This product is Supplied with M4x30mm screws.
This product is Supplied with M4x45mm break off screws.

How to Order

KNB.858.32.2.SQB



Cornwall Knob With Square Back Plate Finish Options

Base Material : Brass		Standard Finishes (2-3 Weeks Delivery)				
						
Bright Chrome (Finish ID:2)	Brush Nickel (Finish ID:3)	Aged Brass (Finish ID:4)	Oil Rubbed Bronze (Finish ID:5)	Polished Nickel (Finish ID:8)	Satin Brass (Finish ID:13)	
Base Material : Brass		Custom Finishes (3-4 Weeks Delivery)*				
						
Split Black and Polished Nickel with Polished Nickel Back Plate (Finish ID:48A)	Split Black and Polished Nickel with Black Back Plate (Finish ID:48B)	Split Black and Satin Brass with Satin Brass Back Plate (Finish ID:49A)	Split Black and Satin Brass with Black Back Plate (Finish ID:49B)	Split Satin Brass and White with Satin Brass Back Plate (Finish ID:50A)	Split Satin Brass and White with White Back Plate (Finish ID:50B)	English Metallic Bronze (Finish ID:51)
						
Split Polished Brass and Oil Rubbed Bronze with Polished Brass Back Plate (Finish ID:57A)	Split Polished Brass and Oil Rubbed Bronze with Oil Rubbed Bronze Back Plate (Finish ID:57B)	Split Black and Chrome with Chrome Back Plate (Finish ID:59A)	Split Black and Chrome with Black Back Plate (Finish ID:59B)	Split Satin Copper and Oil Rubbed Bronze with Satin Copper Back Plate (Finish ID:60A)	Split Satin Copper and Oil Rubbed Bronze with Oil Rubbed Bronze Back Plate (Finish ID:60B)	Graphite (Finish ID:61)
						
Split Aged Brass and English Metallic Bronze with Aged Brass Back Plate (Finish ID:75A)	Split Aged Brass and English Metallic Bronze with English Metallic Bronze Back Plate (Finish ID:75B)	Split Polished Nickel and Satin Brass with Satin Brass Back Plate (Finish ID:77A)	Split Polished Nickel and Satin Brass with Polished Nickel Back Plate (Finish ID:77B)	Split Brush Nickel and Satin Brass with Satin Brass Back Plate (Finish ID:78A)	Split Brush Nickel and Satin Brass with Brush Nickel Back Plate (Finish ID:78B)	Split Oil Rubbed Bronze And Satin Brass with Satin Brass Back Plate (Finish ID:80A)
						
Split Oil Rubbed Bronze And Satin Brass with Oil Rubbed Bronze Back Plate (Finish ID:80B)	Split Graphite and Satin Brass with Satin Brass Back Plate (Finish ID:90A)	Split Graphite and Satin Brass with Graphite Back Plate (Finish ID:90B)	Split Graphite and Brush Chrome with Graphite Back Plate (Finish ID:91A)	Split Graphite and Brush Chrome with Brush Chrome Back Plate (Finish ID:91B)	Ombre (Finish ID:92)	Brush Chrome (Finish ID:95)

- Custom finishes cannot be returned or refunded. We are unable to accept cancellations for custom finish order unless within 48 hours of the order being placed.
- We have uniform pricing for all non-hammered finishes listed above as long as base material and size is same.
- Contact us for customized finishes, refer pages F1, F2, F3 & F4 for finish glossary.
- Backplate options refer page KBP1-1 to KBP14-1.

Cornwall Knob With Square Back Plate Split Finish

KNB.858.XX.XX.SQB

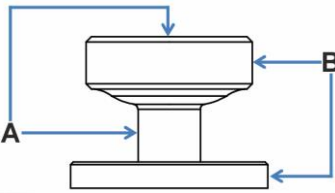
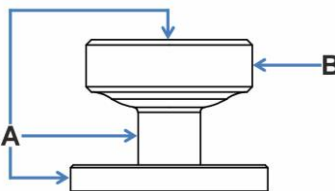
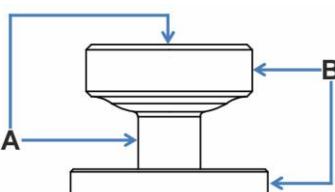
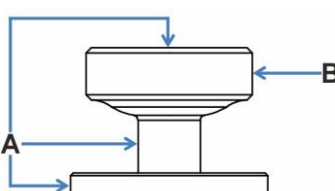
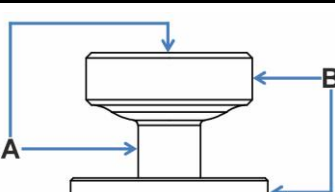
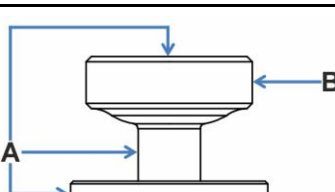
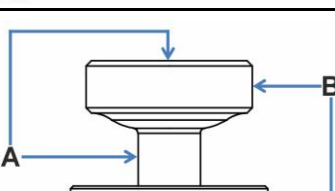
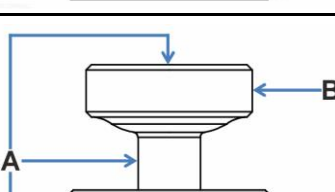
FINISH CODE (XX)	FINISH NAME	LINE DRAWING	A	B
KNB.858.XX.48A.SQB	Split Black and Nickel with Polished Nickel Back Plate		Matte Black	Polished Nickel
KNB.858.XX.48B.SQB	Split Black and Nickel with Black Back Plate		Matte Black	Polished Nickel
KNB.858.XX.49A.SQB	Split Black and Satin Brass with Satin Brass Back Plate		Matte Black	Satin Brass
KNB.858.XX.49B.SQB	Split Black and Satin Brass with Black Back Plate		Matte Black	Satin Brass
KNB.858.XX.50A.SQB	Split Satin Brass and White with Satin Brass Back Plate		White Epoxy	Satin Brass
KNB.858.XX.50B.SQB	Split Satin Brass and White with White Back Plate		White Epoxy	Satin Brass
KNB.858.XX.57A.SQB	Split Lacquered Polished Brass and Oil Rubbed Bronze with Lacquered Polished Brass Back Plate		Oil Rubbed Bronze	Lacquered Polished Brass
KNB.858.XX.57B.SQB	Split Lacquered Polished Brass and Oil Rubbed Bronze with Oil Rubbed Bronze Back Plate		Oil Rubbed Bronze	Lacquered Polished Brass

Cornwall Knob With Square Back Plate Split Finish

KNB.858.XX.XX.SQB

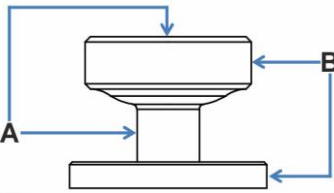
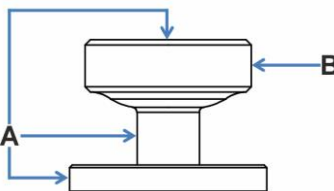
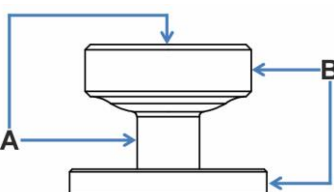
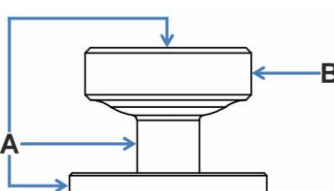
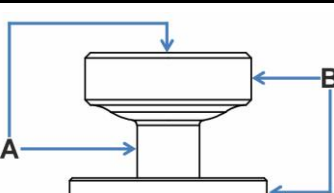
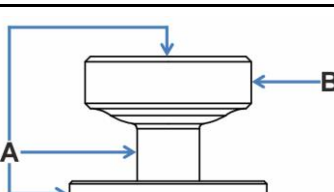
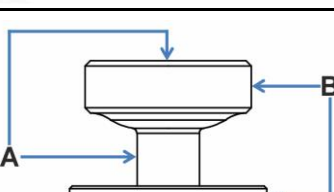
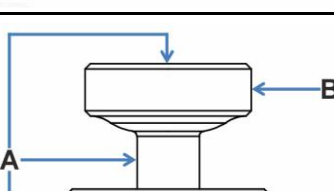
FINISH CODE (XX)	FINISH NAME	LINE DRAWING	A	B
KNB.858.XX.59A.SQB	Split Black and chrome with chrome back plate		Matte Black	Bright Chrome
KNB.858.XX.59B.SQB	Split Black and chrome / Black back plate		Matte Black	Bright Chrome
KNB.858.XX.60A.SQB	Split Satin Copper and Oil Rubbed Bronze with Satin Copper Back Plate		Oil Rubbed Bronze	Satin Copper
KNB.858.XX.60B.SQB	Split Satin Copper and Oil Rubbed Bronze with Oil Rubbed Bronze Back Plate		Oil Rubbed Bronze	Satin Copper
KNB.858.XX.75A.SQB	Split Aged Brass and English Metallic Bronze with Aged Brass Back Plate		English Metallic Bronze	Aged Brass
KNB.858.XX.75B.SQB	Split Aged Brass and English Metallic Bronze with English Metallic Bronze Back Plate		English Metallic Bronze	Aged Brass
KNB.858.XX.77A.SQB	Split Polished Nickel and Satin Brass with Satin Brass Back Plate		Polished Nickel	Satin Brass
KNB.858.XX.77B.SQB	Split Polished Nickel and Satin Brass with Polished Nickel Back Plate		Polished Nickel	Satin Brass

Cornwall Knob With Square Back Plate Split Finish

KNB.858.XX.XX.SQB

FINISH CODE (XX)	FINISH NAME	LINE DRAWING	A	B
KNB.858.XX.78A.SQB	Split Brush Nickel and Satin Brass with Satin Brass Back Plate		Brush Nickel	Satin Brass
KNB.858.XX.78B.SQB	Split Brush Nickel and Satin Brass with Brush Nickel Back Plate		Brush Nickel	Satin Brass
KNB.858.XX.80A.SQB	Split Oil Rubbed Bronze and Satin Brass with Satin Brass Back Plate		Oil Rubbed Bronze	Satin Brass
KNB.858.XX.80B.SQB	Split Oil Rubbed Bronze and Satin Brass with Oil Rubbed Bronze Back Plate		Oil Rubbed Bronze	Satin Brass
KNB.858.XX.90A.SQB	Split Graphite and Satin Brass with Satin Brass Back Plate		Graphite	Satin Brass
KNB.858.XX.90B.SQB	Split Graphite and Satin Brass with Graphite Back Plate		Graphite	Satin Brass
KNB.858.XX.91A.SQB	Split Graphite and Brush Chrome with Brush Chrome Back Plate		Graphite	Brush Chrome
KNB.858.XX.91B.SQB	Split Graphite and Brush Chrome with Graphite Back Plate		Graphite	Brush Chrome



Matt Black (Finish ID : 19)

DORI T-KNOB

“Dori T knob and bar pull handles epitomise the industrial vibe, this raw stripped back look is perfect in natural colours like polished brass, bronze, pewter or aged brass. Well suited for loft apartments or converted warehouses.”

1	Item Code	Size (mm & Inches)	Material	Size (Inches)				Fig.
				A	B	C	D	
	TKNB.871.55.XX	55mm (2.16")	Brass	1.25	2.13	1.25	1.25	1

“XX” in item code denotes Finish ID.

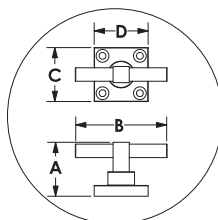

FIG. 1

This product is Supplied with M4x30mm screws.

























This product is Supplied with M6x16mm CSK Dome Slotted screws.

How to Order

TKNB.871.55.19

T KNOB STYLE : DORI SIZE DIAMETER : 55 MM FINISH ID : 19

Dori T-Knob Finish Options

Base Material : Brass			Standard Finishes (2-3 Weeks Delivery)			
						
Bright Chrome (Finish ID:2)	Brush Nickel (Finish ID:3)	Aged Brass (Finish ID:4)	Oil Rubbed Bronze (Finish ID:5)	Unlacquered Polished Brass (Finish ID:7U)	Polished Nickel (Finish ID:8)	Satin Brass (Finish ID:13)
Base Material : Brass			Custom Finishes (3-4 Weeks Delivery)*			
						
Lacquered Polished Brass (Finish ID:7L)	Matte Black (Finish ID:19)	Split Black and Polished Nickel (Finish ID:48)	Split Black and Satin Brass (Finish ID:49)	Split Satin Brass and White (Finish ID:50)	English Metallic Bronze (Finish ID:51)	Split Polished Brass And Oil Rubbed Bronze (Finish ID:57)
						
Split Black And Chrome (Finish ID:59)	Split Satin Copper And Oil Rubbed Bronze (Finish ID:60)	Graphite (Finish ID:61)	Split Aged Brass And English Metallic Bronze (Finish ID:75)	Split Polished Nickel And Satin Brass (Finish ID:77)	Split Brush Nickel and Satin Brass (Finish ID:78)	Split Oil Rubbed Bronze and Satin Brass (Finish ID:80)
						
Split Graphite and Satin Brass (Finish ID:90)	Split Graphite and Brush Chrome (Finish ID:91)	Ombre (Finish ID:92)	Brush Chrome (Finish ID:95)			

- Custom finishes cannot be returned or refunded. We are unable to accept cancellations for custom finish order unless within 48 hours of the order being placed.
- We have uniform pricing for all non-hammered finishes listed above as long as base material and size is same.
- Contact us for customized finishes, refer pages F1, F2, F3 & F4 for finish glossary.
- Backplate options refer page KBP1-1 to KBP14-1.

Dori T Knob Split Finish

TKNB.871.XX.XX

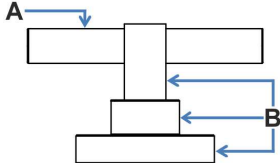
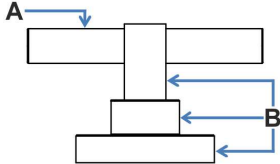
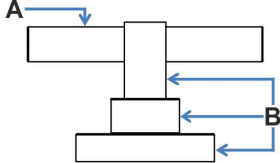
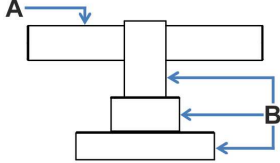
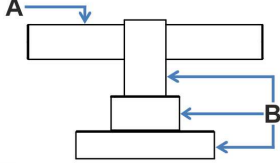
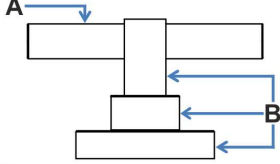
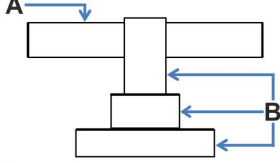
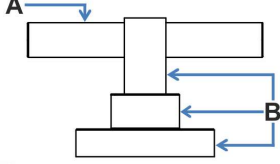
FINISH CODE (XX)	FINISH NAME	LINE DRAWING	A	B
TKNB.871.XX.48	Split Black and Polished Nickel		Matte Black	Polished Nickel
TKNB.871.XX.49	Split Black and Satin Brass		Matte Black	Satin Brass
TKNB.871.XX.50	Split Satin Brass and White		White Epoxy	Satin Brass
TKNB.871.XX.57	Split Polished Brass and Oil Rubbed Bronze		Oil Rubbed Bronze	Lacquered Polished Brass
TKNB.871.XX.59	Split Black and Chrome		Matte Black	Bright Chrome
TKNB.871.XX.60	Split Satin Copper and Oil Rubbed Bronze		Oil Rubbed Bronze	Satin Copper
TKNB.871.XX.75	Split Aged Brass and English Metallic Bronze		English Metallic Bronze	Aged Brass
TKNB.871.XX.77	Split Polished Nickel and Satin Brass		Satin Brass	Polished Nickel

Dori T Knob Split Finish

TKNB.871.XX.XX

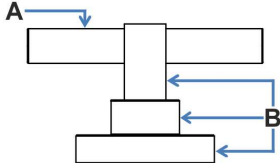
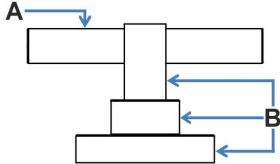
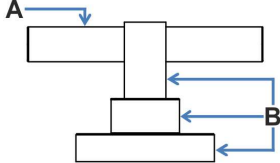
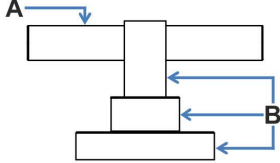
FINISH CODE (XX)	FINISH NAME	LINE DRAWING	A	B
TKNB.871.XX.78	Split Brush Nickel and Satin Brass		Brush Nickel	Satin Brass
TKNB.871.XX.80	Split Oil Rubbed Bronze and Satin Brass		Oil Rubbed Bronze	Satin Brass
TKNB.871.XX.90	Split Graphite and Satin Brass		Graphite	Satin Brass
TKNB.871.XX.91	Split Graphite and Brush Chrome		Graphite	Brush Chrome



Unlacquered Polished Brass (Finish ID : 7U)

ANNE KNOB

“Anne exemplifies the Art Moderne & Art Streamline movement, design in its simplest form devoid of any excess. Available with or without a back plate.”

	Item Code	Size (mm & Inches)	Material	Size (Inches)				Fig.
				A	B	C	D	
1	KNB.872.25.XX	25mm (0.98")	Brass	0.75	0.98	N/A	N/A	1
2	KNB.872.32.XX	32mm (1.26")	Brass	0.94	1.25	N/A	N/A	1

“XX” in item code denotes Finish ID.

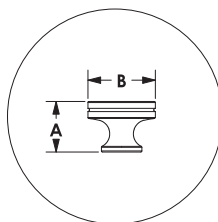

FIG. 1

This product is Supplied with M4x25mm screws.
This product is Supplied with M4x45mm break off screws.

How to Order



Anne Knob Finish Options

Base Material : Brass		Standard Finishes (2-3 Weeks Delivery)				
						
Bright Chrome (Finish ID:2)	Brush Nickel (Finish ID:3)	Aged Brass (Finish ID:4)	Oil Rubbed Bronze (Finish ID:5)	Unlacquered Polished Brass (Finish ID:7U)	Polished Nickel (Finish ID:8)	Satin Brass (Finish ID:13)
Base Material : Brass		Custom Finishes (3-4 Weeks Delivery)*				
						
Lacquered Polished Brass (Finish ID:7L)	English Metallic Bronze (Finish ID:51)	Ombre (Finish ID:92)	Brush Chrome (Finish ID:95)			

- Custom finishes cannot be returned or refunded. We are unable to accept cancellations for custom finish order unless within 48 hours of the order being placed.
- We have uniform pricing for all non-hammered finishes listed above as long as base material and size is same.
- Contact us for customized finishes, refer pages F1, F2, F3 & F4 for finish glossary.
- Backplate options refer page KBP1-1 to KBP14-1.



Brush Nickel (Finish ID:3)

CHICAGO LOOP KNOB

Item Code	Size (mm & Inches)	Material	Size (Inches)				Fig.
			A	B	C	D	
1 KNB.874.1".XX	(25.4mm) 1"	Brass	1.3	3	1	0.28	1

"XX" in item code denotes Finish ID.

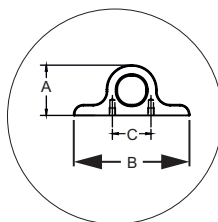

FIG. 1

This product is Supplied with M4x25mm screws.
This product is Supplied with M4x45mm break off screws.

How to Order

KNB.874.1".3

KNOB STYLE : CHICAGO LOOP SIZE DIAMETER : 1 INCH FINISH ID : 3

Chicago Loop Knob Finish Options

Base Material : Brass		Standard Finishes (2-3 Weeks Delivery)				
						
Bright Chrome (Finish ID:2)	Brush Nickel (Finish ID:3)	Aged Brass (Finish ID:4)	Oil Rubbed Bronze (Finish ID:5)	Unlacquered Polished Brass (Finish ID:7U)	Polished Nickel (Finish ID:8)	Satin Brass (Finish ID:13)
Base Material : Brass		Custom Finishes (3-4 Weeks Delivery)*				
						
Lacquered Polished Brass (Finish ID:7L)	Matte Black (Finish ID:19)	Rose Gold (Finish ID:33)	White Epoxy (Finish ID:42)	Satin Copper (Finish ID:58)	Graphite (Finish ID:61)	Titanium (Finish ID:79)
						
Ombre (Finish ID:92)	Brush Chrome (Finish ID:95)					

- Custom finishes cannot be returned or refunded. We are unable to accept cancellations for custom finish order unless within 48 hours of the order being placed.
- We have uniform pricing for all non-hammered finishes listed above as long as base material and size is same.
- Contact us for customized finishes, refer pages F1, F2, F3 & F4 for finish glossary.
- Backplate options refer page KBP1-1 to KBP14-1.



Hammered Over Brush Nickel (Finish ID:12-3)

LEOPARD OVAL KNOB

	Item Code	Size (mm & Inches)	Material	Size (Inches)				Fig.
				A	B	C	D	
1	KNB.875.36.XX	36mm (1.42")	Brass	1.43	1.42	0.94	N/A	1
2	KNB.875.36.XX	36mm (1.42")	Hammered over Brass	1.43	1.42	0.94	N/A	1

"XX" in item code denotes Finish ID.

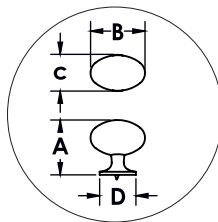































This product is Supplied with M4x25mm screws.
This product is Supplied with M4x45mm break off screws.

How to Order

KNB.875.36.12-3

KNOB STYLE : LEOPARD OVAL SIZE DIAMETER : 36 MM FINISH ID : 12-3

Leopard Oval Knob

Base Material : Brass			Standard Finishes (2-3 Weeks Delivery)			
						
Bright Chrome (Finish ID:2)	Brush Nickel (Finish ID:3)	Aged Brass (Finish ID:4)	Oil Rubbed Bronze (Finish ID:5)	Unlacquered Polished Brass (Finish ID:7U)	Polished Nickel (Finish ID:8)	Satin Brass (Finish ID:13)
Base Material : Brass			Custom Finishes (3-4 Weeks Delivery)*			
						
Lacquered Polished Brass (Finish ID:7L)	Hammered over Brush Nickel (Finish ID:12-3)	Hammered over Aged Brass (Finish ID:12-4)	Hammered Over Oil Rubbed Bronze (Finish ID:12-5)	Hammered over Polished Nickel (Finish ID:12-8)	Hammered over Satin Brass (Finish ID:12-13)	Hammered over Rose Gold (Finish ID:12-33)
						
Antique Copper (Finish ID:15)	Matte Black (Finish ID:19)	Split Black and Polished Nickel (Finish ID:48)	Split Black and Satin Brass (Finish ID:49)	Split Satin Brass and White (Finish ID:50)	English Metallic Bronze (Finish ID:51)	Split Polished Brass And Oil Rubbed Bronze (Finish ID:57)
						
Split Black And Chrome (Finish ID:59)	Split Satin Copper And Oil Rubbed Bronze (Finish ID:60)	Split Aged Brass And English Metallic Bronze (Finish ID:75)	Split Polished Nickel And Satin Brass (Finish ID:77)	Split Brush Nickel and Satin Brass (Finish ID:78)	Split Oil Rubbed Bronze and Satin Brass (Finish ID:80)	Split Graphite and Satin Brass (Finish ID:90)
						
Split Graphite and Brush Chrome (Finish ID:91)	Ombre (Finish ID:92)	Brush Chrome (Finish ID:95)				

- Custom finishes cannot be returned or refunded. We are unable to accept cancellations for custom finish order unless within 48 hours of the order being placed.
- We have uniform pricing for all non-hammered finishes listed above as long as base material and size is same.
- Contact us for customized finishes, refer pages F1, F2, F3 & F4 for finish glossary.
- Backplate options refer page KBP1-1 to KBP14-1.

Leopard Ovel Knob Split Finish

KNB.875.XX.XX

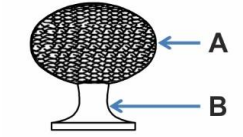
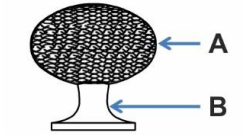
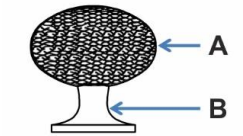
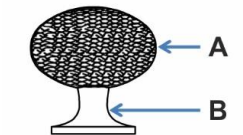
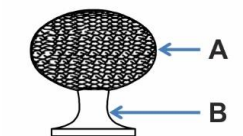
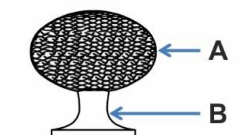
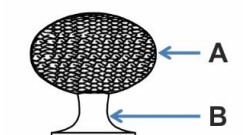
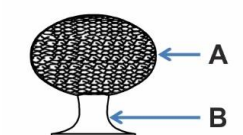
FINISH CODE (XX)	FINISH NAME	LINE DRAWING	A	B
KNB.875.XX.48	Split Black and Polished Nickel		Matte Black	Polished Nickel
KNB.875.XX.49	Split Black and Satin Brass		Matte Black	Satin Brass
KNB.875.XX.50	Split Satin Brass and White		White Epoxy	Satin Brass
KNB.875.XX.57	Split Polished Brass and Oil Rubbed Bronze		Oil Rubbed Bronze	Lacquered Polished Brass
KNB.875.XX.59	Split Black and Chrome		Matte Black	Bright Chrome
KNB.875.XX.60	Split Satin Copper and Oil Rubbed Bronze		Oil Rubbed Bronze	Satin Copper
KNB.875.XX.75	Split Aged Brass and English Metallic Bronze		English Metallic Bronze	Aged Brass
KNB.875.XX.77	Split Polished Nickel and Satin Brass		Satin Brass	Polished Nickel

Leopard Ovel Knob Split Finish

KNB.875.XX.XX

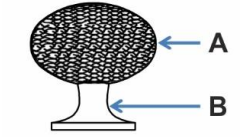
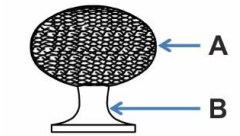
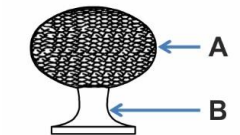
FINISH CODE (XX)	FINISH NAME	LINE DRAWING	A	B
KNB.875.XX.78	Split Brush Nickel and Satin Brass		Brush Nickel	Satin Brass
KNB.875.XX.80	Split Oil Rubbed Bronze and Satin Brass		Oil Rubbed Bronze	Satin Brass
KNB.875.XX.90	Split Graphite and Satin Brass		Graphite	Satin Brass
KNB.875.XX.91	Split Graphite and Brush Chrome		Graphite	Brush Chrome

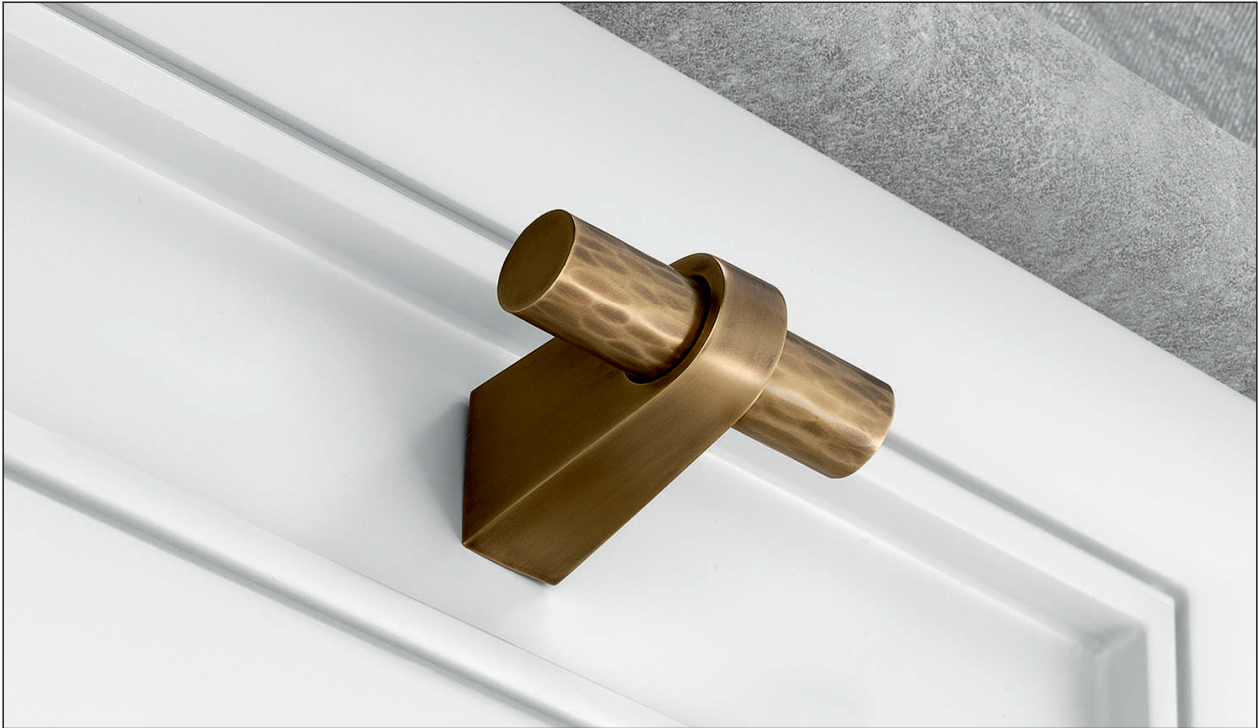

Aged Brass (Finish ID : 4)

LEOPARD T KNOB

“The hammered effect has an appealing decorative quality, applied by hand it creates a texture that stimulates the senses of sight and touch that cannot be recreated by machine. Aged brass creates a unique patina and warmth, polished nickel makes handles and knobs look like pieces of jewellery.”

	Item Code	Size (mm & Inches)	Material	Size (Inches)				Fig.
				A	B	C	D	
1	TKNB.875.55.XX	55mm (2.17")	Brass	1.54	2.17	0.87	0.5	1
2	TKNB.875.90.XX	90mm (3.54")	Brass	1.54	3.54	0.87	0.5	1

“XX” in item code denotes Finish ID.

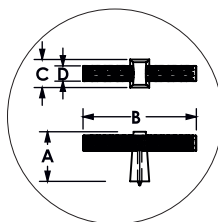

























FIG. 1

This product is Supplied with M4x25mm screws.
This product is Supplied with M4x45mm break off screws.

How to Order

TKNB.875.55.4
T KNOB STYLE : LEOPARD SIZE DIAMETER : 55 MM FINISH ID : 4

Leopard T Knob Finish Options

Base Material : Brass		Standard Finishes (2-3 Weeks Delivery)				
						
Bright Chrome (Finish ID:2)	Brush Nickel (Finish ID:3)	Aged Brass (Finish ID:4)	Oil Rubbed Bronze (Finish ID:5)	Unlacquered Polished Brass (Finish ID:7U)	Polished Nickel (Finish ID:8)	Satin Brass (Finish ID:13)
Base Material : Brass		Custom Finishes (3-4 Weeks Delivery)*				
						
Lacquered Polished Brass (Finish ID:7L)	Antique Copper (Finish ID:15)	Matte Black (Finish ID:19)	Split Black and Polished Nickel (Finish ID:48)	Split Black and Satin Brass (Finish ID:49)	Split Satin Brass and White (Finish ID:50)	English Metallic Bronze (Finish ID:51)
						
Split Polished Brass And Oil Rubbed Bronze (Finish ID:57)	Split Black And Chrome (Finish ID:59)	Split Satin Copper And Oil Rubbed Bronze (Finish ID:60)	Split Aged Brass And English Metallic Bronze (Finish ID:75)	Split Polished Nickel And Satin Brass (Finish ID:77)	Split Polished Nickel and Satin Brass (Finish ID:78)	Split Oil Rubbed Bronze and Satin Brass (Finish ID:80)
						
Split Graphite and Satin Brass (Finish ID:90)	Split Graphite and Brush Chrome (Finish ID:91)	Ombre (Finish ID:92)	Brush Chrome (Finish ID:95)			

- Custom finishes cannot be returned or refunded. We are unable to accept cancellations for custom finish order unless within 48 hours of the order being placed.
- We have uniform pricing for all non-hammered finishes listed above as long as base material and size is same.
- Contact us for customized finishes, refer pages F1, F2, F3 & F4 for finish glossary.
- Backplate options refer page KBP1-1 to KBP14-1.

Leopard T-Knob Split Finish

TKNB.875.XX.XX

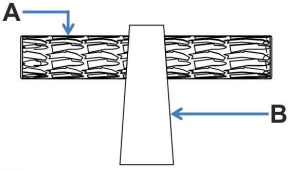
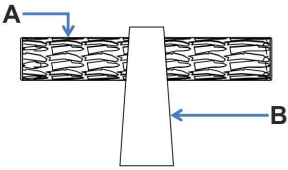
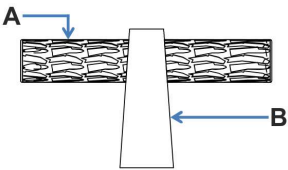
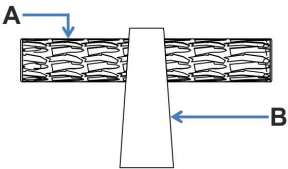
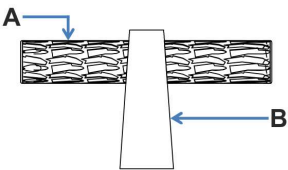
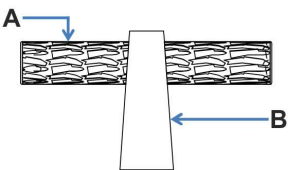
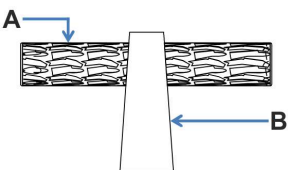
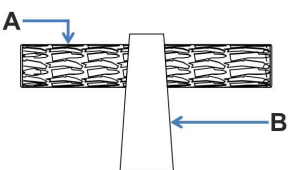
FINISH CODE (XX)	FINISH NAME	LINE DRAWING	A	B
TKNB.875.XX.48	Split Black and Polished Nickel		Matte Black	Polished Nickel
TKNB.875.XX.49	Split Black and Satin Brass		Matte Black	Satin Brass
TKNB.875.XX.50	Split Satin Brass and White		White Epoxy	Satin Brass
TKNB.875.XX.57	Split Polished Brass and Oil Rubbed Bronze		Oil Rubbed Bronze	Lacquered Polished Brass
TKNB.875.XX.59	Split Black and Chrome		Matte Black	Bright Chrome
TKNB.875.XX.60	Split Satin Copper and Oil Rubbed Bronze		Oil Rubbed Bronze	Satin Copper
TKNB.875.XX.75	Split Aged Brass and English Metallic Bronze		English Metallic Bronze	Aged Brass
TKNB.875.XX.77	Split Polished Nickel and Satin Brass		Satin Brass	Polished Nickel

Leopard T-Knob Split Finish

TKNB.875.XX.XX

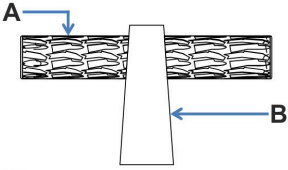
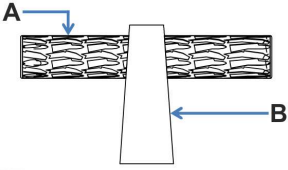
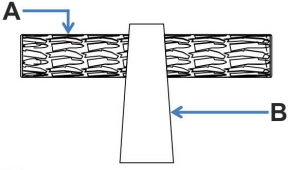
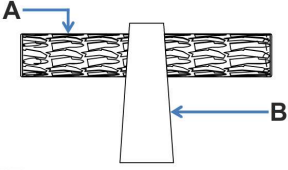
FINISH CODE (XX)	FINISH NAME	LINE DRAWING	A	B
TKNB.875.XX.78	Split Brush Nickel and Satin Brass		Brush Nickel	Satin Brass
TKNB.875.XX.80	Split Oil Rubbed Bronze and Satin Brass		Oil Rubbed Bronze	Satin Brass
TKNB.875.XX.90	Split Graphite and Satin Brass		Graphite	Satin Brass
TKNB.875.XX.91	Split Graphite and Brush Chrome		Graphite	Brush Chrome



Silicon Bronze Light (Finish ID : 53)

THE DOME KNOB

“Inspired by the Sugi-nari Japanese tea bowl, designed to be comfortable to hold.
A simple sleek and refined look for any contemporary setting.”

	Item Code	Size (mm & Inches)	Material	Size (Inches)				Fig.
				A	B	C	D	
1	KNB.881.32.XX	32mm (1.26")	Brass	0.74	1.26	N/A	N/A	1
2	KNB.881.38.XX	38mm (1.5")	Brass	0.87	1.5	N/A	N/A	1
3	KNB.881.50.XX	50mm (1.97")	Brass	1.14	1.97	N/A	N/A	1
4	KNB.881.3.75".XX	95.2mm (3.75")	Brass	2.2	3.75	N/A	N/A	1
5	KNB.881.32.XX	32mm (1.26")	Bronze	0.72	1.26	N/A	N/A	1
6	KNB.881.38.XX	38mm (1.5")	Bronze	0.83	1.5	N/A	N/A	1
7	KNB.881.50.XX	50mm (1.97")	Bronze	1.06	1.95	N/A	N/A	1
8	KNB.881.3.75".XX	95.2mm (3.75")	Bronze	2.2	3.75	N/A	N/A	1

"XX" in item code denotes Finish ID.

This product is Supplied with M4x25mm screws.
This product is Supplied with M4x45mm break off screws.

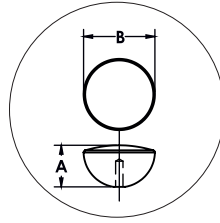



















FIG. 1

How to Order

KNB.881.32.53

KNOB STYLE : THE DOME SIZE DIAMETER : 32 MM FINISH ID : 53

The Dome Knob Finish Options

Base Material : Brass		Standard Finishes (2-3 Weeks Delivery)				
						
Bright Chrome (Finish ID:2)	Brush Nickel (Finish ID:3)	Aged Brass (Finish ID:4)	Oil Rubbed Bronze (Finish ID:5)	Unlacquered Polished Brass (Finish ID:7U)	Polished Nickel (Finish ID:8)	Satin Brass (Finish ID:13)
Base Material : Brass		Custom Finishes (3-4 Weeks Delivery)*				
						
Lacquered Polished Brass (Finish ID:7L)	Matte Black (Finish ID:19)	Rose Gold (Finish ID:33)	English Metallic Bronze (Finish ID:51)	Graphite (Finish ID:61)	Titanium (Finish ID:79)	Ombre (Finish ID:92)
						
Brush Chrome (Finish ID:95)						
Base Material : Bronze		Custom Finishes (3-4 Weeks Delivery)*				
						
Silicon Bronze Light (Finish ID:53)	Silicon Bronze Dark (Finish ID:53D)	White Bronze (Finish ID:54)				

- Custom finishes cannot be returned or refunded. We are unable to accept cancellations for custom finish order unless within 48 hours of the order being placed.
- We have uniform pricing for all non-hammered finishes listed above as long as base material and size is same.
- Contact us for customized finishes, refer pages F1, F2, F3 & F4 for finish glossary.
- Backplate options refer page KBP1-1 to KBP14-1.



Oil Rubbed Bronze (Finish ID : 5)

SUFFOLK KNOB

“The ovoid shape with its convex surface reflects light beautifully”

Item Code	Size (mm & Inches)	Material	Size (Inches)				Fig.
			A	B	C	D	
1 KNB.899.35.XX	35mm (1.38")	Brass	1.56	1.38	0.63	N/A	1

“XX” in item code denotes Finish ID.

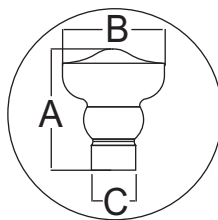

FIG. 1

This product is Supplied with M4x25mm screws.
This product is Supplied with M4x45mm break off screws.

How to Order



Suffolk Knob Finish Options

Base Material : Brass		Standard Finishes (2-3 Weeks Delivery)				
						
Bright Chrome (Finish ID:2)	Brush Nickel (Finish ID:3)	Aged Brass (Finish ID:4)	Oil Rubbed Bronze (Finish ID:5)	Unlacquered Polished Brass (Finish ID:7U)	Polished Nickel (Finish ID:8)	Satin Brass (Finish ID:13)
Base Material : Brass		Custom Finishes (3-4 Weeks Delivery)*				
						
Lacquered Polished Brass (Finish ID:7L)	Ombre (Finish ID:92)	Brush Chrome (Finish ID:95)				

- Custom finishes cannot be returned or refunded. We are unable to accept cancellations for custom finish order unless within 48 hours of the order being placed.
- We have uniform pricing for all non-hammered finishes listed above as long as base material and size is same.
- Contact us for customized finishes, refer pages F1, F2, F3 & F4 for finish glossary.
- Backplate options refer page KBP1-1 to KBP14-1.



Brush Nickel (Finish ID : 3)

JAZZ KNOB

“The juxtaposition of two surfaces where knurled meets smooth. The contrast highlights the detail.”

	Item Code	Size (mm & Inches)	Material	Size (Inches)				Fig.
				A	B	C	D	
1	KNB.836.26.8	26mm (1.02")	Brass	1.4	1.02	0.94	N/A	1
2	KNB.836.30.8	30mm (1.18")	Brass	1.54	1.18	1.1	N/A	1

“XX” in item code denotes Finish ID.

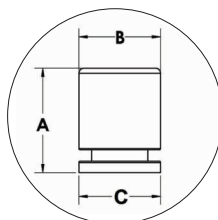

FIG. 1



























This product is Supplied with M4x45mm break off screws.

How to Order

KNB.836.26.3

KNOB STYLE : JAZZ SIZE DIAMETER : 26 MM FINISH ID : 3

Jazz Knob Finish Options

Base Material : Brass			Standard Finishes (2-3 Weeks Delivery)			
						
Bright Chrome (Finish ID:2)	Brush Nickel (Finish ID:3)	Aged Brass (Finish ID:4)	Oil Rubbed Bronze (Finish ID:5)	Unlacquered Polished Brass (Finish ID:7U)	Polished Nickel (Finish ID:8)	Satin Brass (Finish ID:13)
Base Material : Brass			Custom Finishes (3-4 Weeks Delivery)*			
						
Lacquered Polished Brass (Finish ID:7L)	Antique Copper (Finish ID:15)	Matte Black (Finish ID:19)	Split Black and Polished Nickel (Finish ID:48)	Split Black and Satin Brass (Finish ID:49)	Split Satin Brass and White (Finish ID:50)	English Metallic Bronze (Finish ID:51)
						
Split Polished Brass And Oil Rubbed Bronze (Finish ID:57)	Split Black And Chrome (Finish ID:59)	Split Satin Copper And Oil Rubbed Bronze (Finish ID:60)	Graphite (Finish ID:61)	Split Aged Brass And English Metallic Bronze (Finish ID:75)	Split Polished Nickel And Satin Brass (Finish ID:77)	Split Brush Nickel and Satin Brass (Finish ID:78)
						
Titanium (Finish ID:79)	Split Oil Rubbed Bronze and Satin Brass (Finish ID:80)	Split Graphite and Satin Brass (Finish ID:90)	Split Graphite and Brush Chrome (Finish ID:91)	Ombre (Finish ID:92)	Brush Chrome (Finish ID:95)	

- Custom finishes cannot be returned or refunded. We are unable to accept cancellations for custom finish order unless within 48 hours of the order being placed.
- We have uniform pricing for all non-hammered finishes listed above as long as base material and size is same.
- Contact us for customized finishes, refer pages F1, F2, F3 & F4 for finish glossary.
- Backplate options refer page KBP1-1 to KBP14-1.

Jazz Knob Split Finish

KNB.836.XX.XX

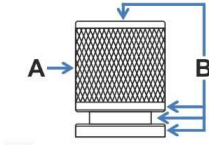
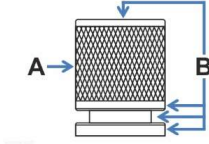
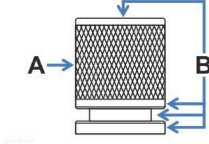
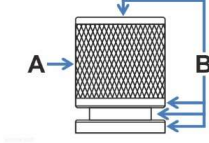
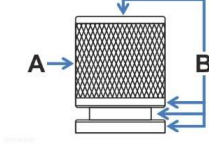
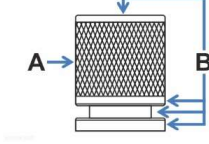
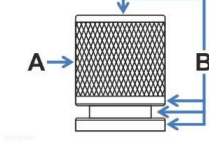
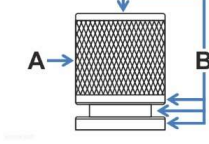
FINISH CODE (XX)	FINISH NAME	LINE DRAWING	A	B
KNB.836.XX.48	Split Black and Polished Nickel		Matte Black	Polished Nickel
KNB.836.XX.49	Split Black and Satin Brass		Matte Black	Satin Brass
KNB.836.XX.50	Split Satin Brass and White		White Epoxy	Satin Brass
KNB.836.XX.57	Split Polished Brass and Oil Rubbed Bronze		Oil Rubbed Bronze	Lacquered Polished Brass
KNB.836.XX.59	Split Black and Chrome		Matte Black	Bright Chrome
KNB.836.XX.60	Split Satin Copper and Oil Rubbed Bronze		Oil Rubbed Bronze	Satin Copper
KNB.836.XX.75	Split Aged Brass and English Metallic Bronze		English Metallic Bronze	Aged Brass
KNB.836.XX.77	Split Polished Nickel and Satin Brass		Satin Brass	Polished Nickel

Jazz Knob Split Finish

KNB.836.XX.XX

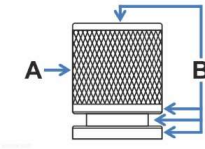
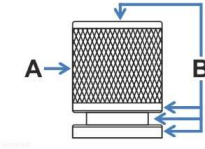
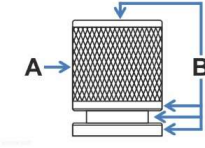
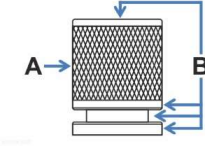
FINISH CODE (XX)	FINISH NAME	LINE DRAWING	A	B
KNB.836.XX.78	Split Brush Nickel and Satin Brass		Satin Brass	Brush Nickel
KNB.836.XX.80	Split Oil Rubbed Bronze and Satin Brass		Oil Rubbed Bronze	Satin Brass
KNB.836.XX.90	Split Graphite and Satin Brass		Graphite	Satin Brass
KNB.836.XX.91	Split Graphite and Brush Chrome		Graphite	Brush Chrome

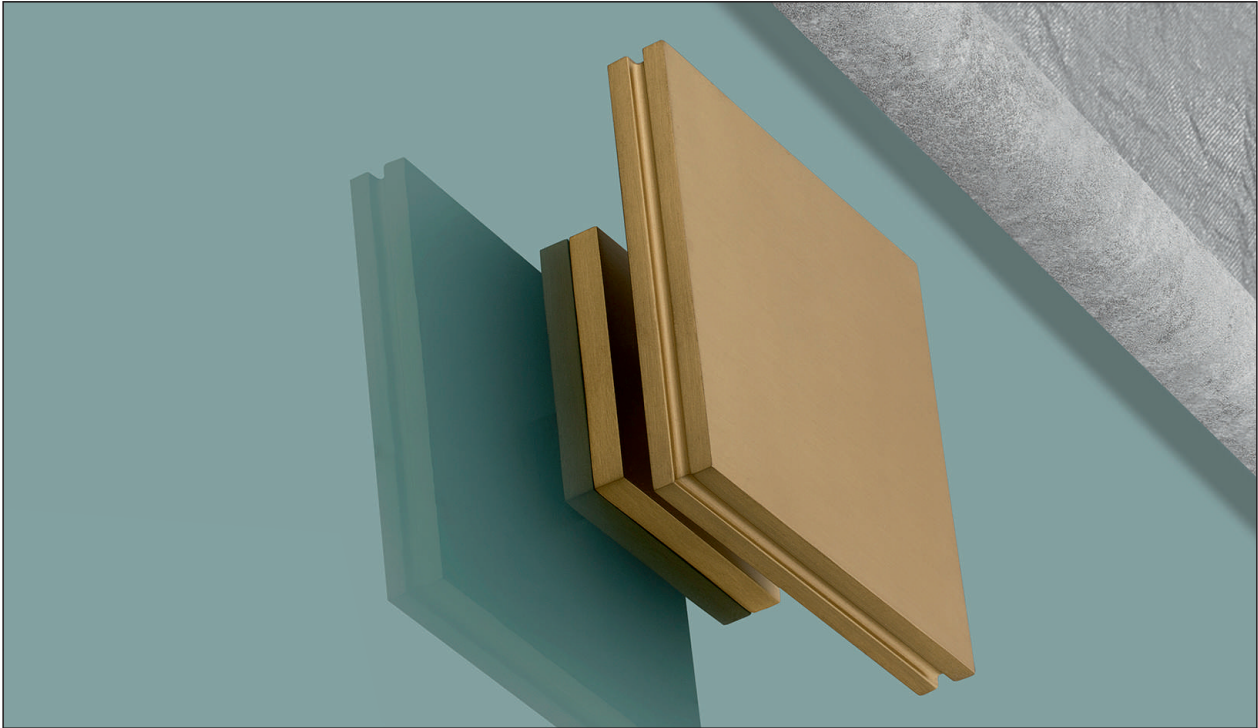

Satin Brass (Finish ID : 13)

STRADA KNOB

	Item Code	Size (mm & Inches)	Material	Size (Inches)				Fig.
				A	B	C	D	
1	KNB.902.3.75".XX	95.25mm (3.75")	Brass	1.34	3.75	3.75	2.25	1
2	KNB.902.4.5".XX	114.3mm (4.5")	Brass	1.34	4.49	4.49	2.25	1

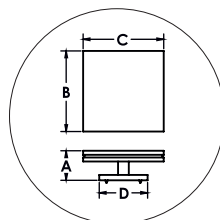

FIG. 1

This product is Supplied with M4x30mm screws.
This product is Supplied with M4x45mm break off screws.

How to Order

KNB.902.3.75".13

KNOB STYLE :STRADA SIZE DIAMETER : 3.75 INCH FINISH ID : 13

Strada Knob Finish Options

Base Material : Brass		Standard Finishes (2-3 Weeks Delivery)				
						
Bright Chrome (Finish ID:2)	Brush Nickel (Finish ID:3)	Aged Brass (Finish ID:4)	Oil Rubbed Bronze (Finish ID:5)	Unlacquered Polished Brass (Finish ID:7U)	Polished Nickel (Finish ID:8)	Satin Brass (Finish ID:13)
Base Material : Brass		Custom Finishes (3-4 Weeks Delivery)*				
						
Lacquered Polished Brass (Finish ID:7L)	Matte Black (Finish ID:19)	Graphite (Finish ID:61)	Ombre (Finish ID:92)	Brush Chrome (Finish ID:95)		

- Custom finishes cannot be returned or refunded. We are unable to accept cancellations for custom finish order unless within 48 hours of the order being placed.
- We have uniform pricing for all non-hammered finishes listed above as long as base material and size is same.
- Contact us for customized finishes, refer pages F1, F2, F3 & F4 for finish glossary.
- Backplate options refer page KBP1-1 to KBP14-1.



Split Black and Satin Brass with Satin Brass Back Plate (Finish ID:49A)

ODEL KNOB

“Odel with its simple smooth design and concentric grooves could almost be seeking inspiration from the famous Guggenheim Museum in New York.”

	Item Code	Size (mm & Inches)	Material	Size (Inches)				Fig.
				A	B	C	D	
1	KNB.903.25.XX	25mm (0.98")	Brass	1.44	0.98	1.3	2.52	1
2	KNB.903.32.XX	32mm (1.26")	Brass	1.71	1.22	1.3	2.52	1

“XX” in item code denotes Finish ID.

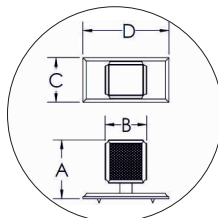

FIG. 1





























This product is Supplied with M4x30mm screws.
This product is Supplied with M4x45mm break off screws.

How to Order

KNB.903.25.49A

KNOB STYLE : ODEL SIZE DIAMETER : 25 MM FINISH ID : 49A

Odel Knob Finish Options

Base Material : Brass			Standard Finishes (2-3 Weeks Delivery)			
						
Bright Chrome (Finish ID:2)	Brush Nickel (Finish ID:3)	Aged Brass (Finish ID:4)	Oil Rubbed Bronze (Finish ID:5)	Unlacquered Polished Brass (Finish ID:7U)	Polished Nickel (Finish ID:8)	Satin Brass (Finish ID:13)
Base Material : Brass			Custom Finishes (3-4 Weeks Delivery)*			
						
Lacquered Polished Brass (Finish ID:7L)	Antique Copper (Finish ID:15)	Matte Black (Finish ID:19)	Split Black and Polished Nickel with Polished Nickel Back Plate (Finish ID:48A)	Split Black and Polished Nickel with Black Back Plate (Finish ID:48B)	Split Black and Satin Brass with Satin Brass Back Plate (Finish ID:49A)	Split Black and Satin Brass with Black Back Plate (Finish ID:49B)
						
Split Satin Brass and White with Satin Brass Back Plate (Finish ID:50A)	Split Satin Brass and White with White Back Plate (Finish ID:50B)	English Metallic Bronze (Finish ID:51)	Split Polished Brass and Oil Rubbed Bronze with Polished Brass Back Plate (Finish ID:57A)	Split Polished Brass and Oil Rubbed Bronze with Oil Rubbed Bronze Back Plate (Finish ID:57B)	Split Black and Chrome with Chrome Back Plate (Finish ID:59A)	Split Black and Chrome with Black Back Plate (Finish ID:59B)
						
Split Satin Copper and Oil Rubbed Bronze with Satin Copper Back Plate (Finish ID:60A)	Split Satin Copper and Oil Rubbed Bronze with Oil Rubbed Bronze Back Plate (Finish ID:60B)	Graphite (Finish ID:61)	Split Aged Brass and English Metallic Bronze with Aged Brass Back Plate (Finish ID:75A)	Split Aged Brass and English Metallic Bronze with English Metallic Bronze Back Plate (Finish ID:75B)	Split Polished Nickel and Satin Brass with Satin Brass Back Plate (Finish ID:77A)	Split Polished Nickel and Satin Brass with Polished Nickel Back Plate (Finish ID:77B)

- Custom finishes cannot be returned or refunded. We are unable to accept cancellations for custom finish order unless within 48 hours of the order being placed.
- We have uniform pricing for all non-hammered finishes listed above as long as base material and size is same.
- Contact us for customized finishes, refer pages F1, F2, F3 & F4 for finish glossary.
- Backplate options refer page KBP1-1 to KBP14-1.

Base Material : Brass		Custom Finishes (3-4 Weeks Delivery)*				
 Split Brush Nickel and Satin Brass with Satin Brass Back Plate (Finish ID:78A)	 Split Brush Nickel and Satin Brass with Brush Nickel Back Plate (Finish ID:78B)	 Titanium (Finish ID:79)	 Split Oil Rubbed Bronze And Satin Brass with Satin Brass Back Plate (Finish ID:80A)	 Split Oil Rubbed Bronze And Satin Brass with Oil Rubbed Bronze Back Plate (Finish ID:80B)	 Split Graphite and Satin Brass with Satin Brass Back Plate (Finish ID:90A)	 Split Graphite and Satin Brass with Graphite Back Plate (Finish ID:90B)
 Split Graphite and Brush Chrome with Graphite Back Plate (Finish ID:91A)	 Split Graphite and Brush Chrome with Brush Chrome Back Plate (Finish ID:91B)	 Ombre (Finish ID:92)	 Brush Chrome (Finish ID:95)			

- Custom finishes cannot be returned or refunded. We are unable to accept cancellations for custom finish order unless within 48 hours of the order being placed.
- We have uniform pricing for all non-hammered finishes listed above as long as base material and size is same.
- Contact us for customized finishes, refer pages F1, F2, F3 & F4 for finish glossary.
- Backplate options refer page KBP1-1 to KBP14-1.

Odel Knob With Back Plate Split Finish

KNB.903.XX.XX

FINISH CODE (XX)	FINISH NAME	LINE DRAWING	A	B
KNB.903.XX.48A	Split Black and Nickel with Polished Nickel Back Plate		Matte Black	Polished Nickel
KNB.903.XX.48B	Split Black and Nickel with Black Back Plate		Matte Black	Polished Nickel
KNB.903.XX.49A	Split Black and Satin Brass with Satin Brass Back Plate		Matte Black	Satin Brass
KNB.903.XX.49B	Split Black and Satin Brass with Black Back Plate		Matte Black	Satin Brass
KNB.903.XX.50A	Split Satin Brass and White with Satin Brass Back Plate		White Epoxy	Satin Brass
KNB.903.XX.50B	Split Satin Brass and White with White Back Plate		White Epoxy	Satin Brass
KNB.903.XX.57A	Split Lacquered Polished Brass and Oil Rubbed Bronze with Lacquered Polished Brass Back Plate		Oil Rubbed Bronze	Lacquered Polished Brass
KNB.903.XX.57B	Split Lacquered Polished Brass and Oil Rubbed Bronze with Oil Rubbed Bronze Back Plate		Oil Rubbed Bronze	Lacquered Polished Brass

Odel Knob With Back Plate Split Finish

KNB.903.XX.XX

FINISH CODE (XX)	FINISH NAME	LINE DRAWING	A	B
KNB.903.XX.59A	Split Black and chrome with chrome back plate		Matte Black	Bright Chrome
KNB.903.XX.59B	Split Black and chrome / Black back plate		Matte Black	Bright Chrome
KNB.903.XX.60A	Split Satin Copper and Oil Rubbed Bronze with Satin Copper Back Plate		Oil Rubbed Bronze	Satin Copper
KNB.903.XX.60B	Split Satin Copper and Oil Rubbed Bronze with Oil Rubbed Bronze Back Plate		Oil Rubbed Bronze	Satin Copper
KNB.903.XX.75A	Split Aged Brass and English Metallic Bronze with Aged Brass Back Plate		English Metallic Bronze	Aged Brass
KNB.903.XX.75B	Split Aged Brass and English Metallic Bronze with English Metallic Bronze Back Plate		English Metallic Bronze	Aged Brass
KNB.903.XX.77A	Split Polished Nickel and Satin Brass with Satin Brass Back Plate		Satin Brass	Polished Nickel
KNB.903.XX.77B	Split Polished Nickel and Satin Brass with Polished Nickel Back Plate		Satin Brass	Polished Nickel

Odel Knob With Back Plate Split Finish

KNB.903.XX.XX

FINISH CODE (XX)	FINISH NAME	LINE DRAWING	A	B
KNB.903.XX.78A	Split Brush Nickel and Satin Brass with Satin Brass Back Plate		Satin Brass	Brush Nickel
KNB.903.XX.78B	Split Brush Nickel and Satin Brass with Brush Nickel Back Plate		Satin Brass	Brush Nickel
KNB.903.XX.80A	Split Oil Rubbed Bronze and Satin Brass with Satin Brass Back Plate		Oil Rubbed Bronze	Satin Brass
KNB.903.XX.80B	Split Oil Rubbed Bronze and Satin Brass with Oil Rubbed Bronze Back Plate		Oil Rubbed Bronze	Satin Brass
KNB.903.XX.90A	Split Graphite and Satin Brass with Satin Brass Back Plate		Graphite	Satin Brass
KNB.903.XX.90B	Split Graphite and Satin Brass with Graphite Back Plate		Graphite	Satin Brass
KNB.903.XX.91A	Split Graphite and Brush Chrome with Brush Chrome Back Plate		Graphite	Brush Chrome
KNB.903.XX.91B	Split Graphite and Brush Chrome with Graphite Back Plate		Graphite	Brush Chrome



Titanium (Finish ID : 79)

ODEL T KNOB

“Odel with its simple smooth design and concentric grooves could almost be seeking inspiration from the famous Guggenheim Museum in New York.”

	Item Code	Size (mm & Inches)	Material	Size (Inches)				Fig.
				A	B	C	D	
1	TKNB.903.2"XX	50.8mm (2")	Brass	1.23	0.75	2	1.02	1
2	TKNB.903.4"XX	101.6mm (4")	Brass	1.23	0.75	4	1.02	1

"XX" in item code denotes Finish ID.

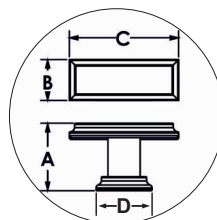

FIG. 1



























This product is Supplied with M4x30mm screws.
This product is Supplied with M4x45mm break off screws.

How to Order

TKNB.903.2".79

T KNOB STYLE : ODEL SIZE DIAMETER : 2 INCH FINISH ID : 79

Odel T Knob Finish Options

Base Material : Brass			Standard Finishes (2-3 Weeks Delivery)			
						
Bright Chrome (Finish ID:2)	Brush Nickel (Finish ID:3)	Aged Brass (Finish ID:4)	Oil Rubbed Bronze (Finish ID:5)	Unlacquered Polished Brass (Finish ID:7U)	Polished Nickel (Finish ID:8)	Satin Brass (Finish ID:13)
Base Material : Brass			Custom Finishes (3-4 Weeks Delivery)*			
						
Lacquered Polished Brass (Finish ID:7L)	Antique Copper (Finish ID:15)	Matte Black (Finish ID:19)	Split Black and Polished Nickel (Finish ID:48)	Split Black and Satin Brass (Finish ID:49)	Split Satin Brass and White (Finish ID:50)	English Metallic Bronze (Finish ID:51)
						
Split Polished Brass And Oil Rubbed Bronze (Finish ID:57)	Split Black And Chrome (Finish ID:59)	Split Satin Copper And Oil Rubbed Bronze (Finish ID:60)	Graphite (Finish ID:61)	Split Aged Brass And English Metallic Bronze (Finish ID:75)	Split Polished Nickel And Satin Brass (Finish ID:77)	Split Brush Nickel And Satin Brass (Finish ID:78)
						
Titanium (Finish ID:79)	Split Oil Rubbed Bronze and Satin Brass (Finish ID:80)	Split Graphite and Satin Brass (Finish ID:90)	Split Graphite and Brush Chrome (Finish ID:91)	Ombre (Finish ID:92)	Brush Chrome (Finish ID:95)	

- Custom finishes cannot be returned or refunded. We are unable to accept cancellations for custom finish order unless within 48 hours of the order being placed.
- We have uniform pricing for all non-hammered finishes listed above as long as base material and size is same.
- Contact us for customized finishes, refer pages F1, F2, F3 & F4 for finish glossary.
- Backplate options refer page KBP1-1 to KBP14-1.

Odel T knob Split Finish

TKNB.903.XX.XX

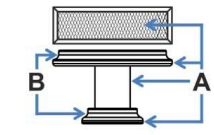
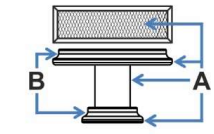
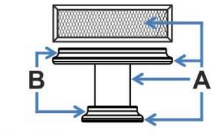
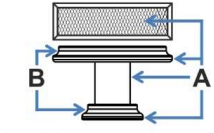
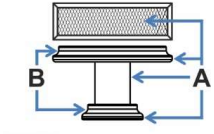
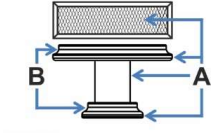
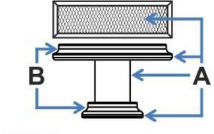
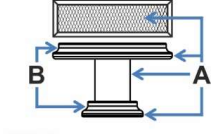
FINISH CODE (XX)	FINISH NAME	LINE DRAWING	A	B
TKNB.903.XX.48	Split Black and Polished Nickel		Matte Black	Polished Nickel
TKNB.903.XX.49	Split Black and Satin Brass		Matte Black	Satin Brass
TKNB.903.XX.50	Split Satin Brass and White		White Epoxy	Satin Brass
TKNB.903.XX.57	Split Polished Brass and Oil Rubbed Bronze		Oil Rubbed Bronze	Lacquered Polished Brass
TKNB.903.XX.59	Split Black and Chrome		Matte Black	Bright Chrome
TKNB.903.XX.60	Split Satin Copper and Oil Rubbed Bronze		Oil Rubbed Bronze	Satin Copper
TKNB.903.XX.75	Split Aged Brass and English Metallic Bronze		English Metallic Bronze	Aged Brass
TKNB.903.XX.77	Split Polished Nickel and Satin Brass		Satin Brass	Polished Nickel

Odel T knob Split Finish

TKNB.903.XX.XX

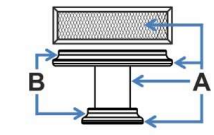
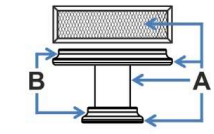
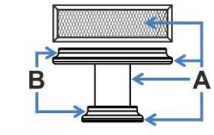
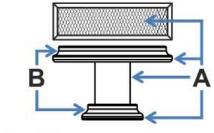
FINISH CODE (XX)	FINISH NAME	LINE DRAWING	A	B
TKNB.903.XX.78	Split Brush Nickel and Satin Brass		Brush Nickel	Satin Brass
TKNB.903.XX.80	Split Oil Rubbed Bronze and Satin Brass		Oil Rubbed Bronze	Satin Brass
TKNB.903.XX.90	Split Graphite and Satin Brass		Graphite	Satin Brass
TKNB.903.XX.91	Split Graphite and Brush Chrome		Graphite	Brush Chrome



Bright Chrome (Finish ID : 2)

DANBURY KNOB

	Item Code	Size (mm & Inches)	Material	Size (Inches)				Fig.
				A	B	C	D	
1	KNB.905.32.XX	32mm (1.26")	Brass	1.46	1.26	N/A	N/A	1
2	KNB.905.38.XX	38mm (1.5")	Brass	1.62	1.5	N/A	N/A	1
3	KNB.905.32.XX	32mm (1.26")	Hammered over Brass	1.46	1.26	N/A	N/A	1
4	KNB.905.38.XX	38mm (1.5")	Hammered over Brass	1.62	1.5	N/A	N/A	1

"XX" in item code denotes Finish ID.

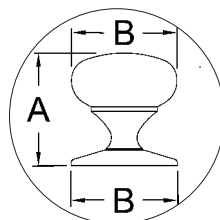

FIG. 1





























This product is Supplied with M4x30mm screws.
This product is Supplied with M4x45mm break off screws.

How to Order



















KNB.905.32.2

KNOB STYLE : DANBURY SIZE DIAMETER : 32 MM FINISH ID : 2

Danbury Knob Finish Options

Base Material : Brass		Standard Finishes (2-3 Weeks Delivery)				
						
Bright Chrome (Finish ID:2)	Brush Nickel (Finish ID:3)	Aged Brass (Finish ID:4)	Oil Rubbed Bronze (Finish ID:5)	Unlacquered Polished Brass (Finish ID:7U)	Polished Nickel (Finish ID:8)	Satin Brass (Finish ID:13)
Base Material : Brass		Custom Finishes (3-4 Weeks Delivery)*				
						
Lacquered Polished Brass (Finish ID:7L)	Hammered over Brush Nickel (Finish ID:12-3)	Hammered over Aged Brass (Finish ID:12-4)	Hammered Over Oil Rubbed Bronze (Finish ID:12-5)	Hammered over Polished Nickel (Finish ID:12-8)	Hammered over Satin Brass (Finish ID:12-13)	Hammered over Rose Gold (Finish ID:12-33)
						
Antique Copper (Finish ID:15)	Matte Black (Finish ID:19)	Split Black and Polished Nickel with Polished Nickel Back Plate (Finish ID:48A)	Split Black and Polished Nickel with Black Back Plate (Finish ID:48B)	Split Black and Satin Brass with Satin Brass Back Plate (Finish ID:49A)	Split Black and Satin Brass with Black Back Plate (Finish ID:49B)	Split Satin Brass and White with Satin Brass Back Plate (Finish ID:50A)
						
Split Satin Brass and White with White Back Plate (Finish ID:50B)	English Metallic Bronze (Finish ID:51)	Split Polished Brass and Oil Rubbed Bronze with Polished Brass Back Plate (Finish ID:57A)	Split Polished Brass and Oil Rubbed Bronze with Oil Rubbed Bronze Back Plate (Finish ID:57B)	Satin Copper (Finish ID:58)	Split Black and Chrome with Chrome Back Plate (Finish ID:59A)	Split Black and Chrome with Black Back Plate (Finish ID:59B)

- Custom finishes cannot be returned or refunded. We are unable to accept cancellations for custom finish order unless within 48 hours of the order being placed.
- We have uniform pricing for all non-hammered finishes listed above as long as base material and size is same.
- Contact us for customized finishes, refer pages F1, F2, F3 & F4 for finish glossary.
- Backplate options refer page KBP1-1 to KBP14-1.

Base Material : Brass		Custom Finishes (3-4 Weeks Delivery)*				
						
Split Satin Copper and Oil Rubbed Bronze with Satin Copper Back Plate (Finish ID:60A)	Split Satin Copper and Oil Rubbed Bronze with Oil Rubbed Bronze Back Plate (Finish ID:60B)	Graphite (Finish ID:61)	Split Aged Brass and English Metallic Bronze with Aged Brass Back Plate (Finish ID:75A)	Split Aged Brass and English Metallic Bronze with English Metallic Bronze Back Plate (Finish ID:75B)	Split Polished Nickel and Satin Brass with Satin Brass Back Plate (Finish ID:77A)	Split Polished Nickel and Satin Brass with Polished Nickel Back Plate (Finish ID:77B)
						
Split Brush Nickel and Satin Brass with Satin Brass Back Plate (Finish ID:78A)	Split Brush Nickel and Satin Brass with Brush Nickel Back Plate (Finish ID:78B)	Titanium (Finish ID:79)	Split Oil Rubbed Bronze And Satin Brass with Satin Brass Back Plate (Finish ID:80A)	Split Oil Rubbed Bronze And Satin Brass with Oil Rubbed Bronze Back Plate (Finish ID:80B)	Split Graphite and Satin Brass with Satin Brass Back Plate (Finish ID:90A)	Split Graphite and Satin Brass with Graphite Back Plate (Finish ID:90B)
						
Split Graphite and Brush Chrome with Graphite Back Plate (Finish ID:91A)	Split Graphite and Brush Chrome with Brush Chrome Back Plate (Finish ID:91B)	Ombre (Finish ID:92)	Brush Chrome (Finish ID:95)			

- Custom finishes cannot be returned or refunded. We are unable to accept cancellations for custom finish order unless within 48 hours of the order being placed.
- We have uniform pricing for all non-hammered finishes listed above as long as base material and size is same.
- Contact us for customized finishes, refer pages F1, F2, F3 & F4 for finish glossary.
- Backplate options refer page KBP1-1 to KBP14-1.

Danbury Knob Split Finish

KNB.905.XX.XX

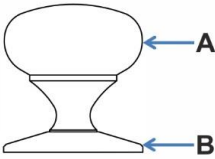
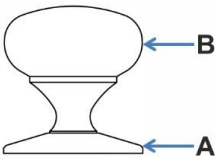
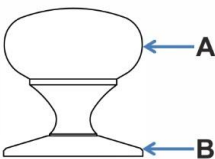
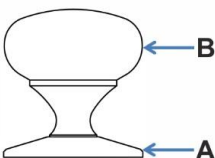
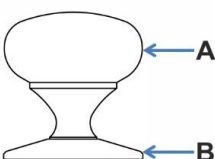
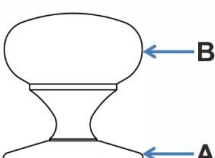
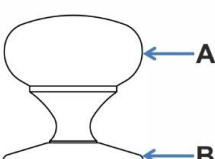
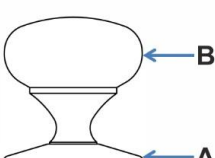
FINISH CODE (XX)	FINISH NAME	LINE DRAWING	A	B
KNB.905.XX.48A	Split Black and Nickel with Polished Nickel Back Plate		Matte Black	Polished Nickel
KNB.905.XX.48B	Split Black and Nickel with Black Back Plate		Matte Black	Polished Nickel
KNB.905.XX.49A	Split Black and Satin Brass with Satin Brass Back Plate		Matte Black	Satin Brass
KNB.905.XX.49B	Split Black and Satin Brass with Black Back Plate		Matte Black	Satin Brass
KNB.905.XX.50A	Split Satin Brass and White with Satin Brass Back Plate		White Epoxy	Satin Brass
KNB.905.XX.50B	Split Satin Brass and White with White Back Plate		White Epoxy	Satin Brass
KNB.905.XX.57A	Split Lacquered Polished Brass and Oil Rubbed Bronze with Lacquered Polished Brass Back Plate		Oil Rubbed Bronze	Lacquered Polished Brass
KNB.905.XX.57B	Split Lacquered Polished Brass and Oil Rubbed Bronze with Oil Rubbed Bronze Back Plate		Oil Rubbed Bronze	Lacquered Polished Brass

Danbury Knob Split Finish

KNB.905.XX.XX

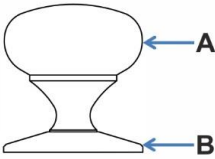
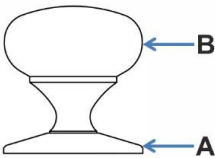
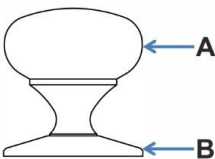
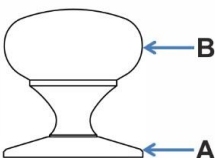
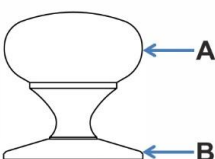
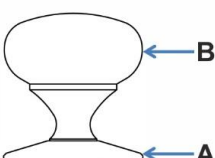
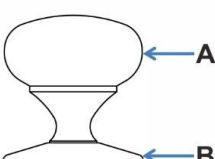
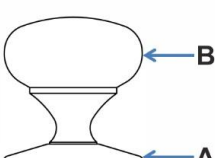
FINISH CODE (XX)	FINISH NAME	LINE DRAWING	A	B
KNB.905.XX.59A	Split Black and chrome with chrome back plate		Matte Black	Bright Chrome
KNB.905.XX.59B	Split Black and chrome / Black back plate		Matte Black	Bright Chrome
KNB.905.XX.60A	Split Satin Copper and Oil Rubbed Bronze with Satin Copper Back Plate		Oil Rubbed Bronze	Satin Copper
KNB.905.XX.60B	Split Satin Copper and Oil Rubbed Bronze with Oil Rubbed Bronze Back Plate		Oil Rubbed Bronze	Satin Copper
KNB.905.XX.75A	Split Aged Brass and English Metallic Bronze with Aged Brass Back Plate		English Metallic Bronze	Aged Brass
KNB.905.XX.75B	Split Aged Brass and English Metallic Bronze with English Metallic Bronze Back Plate		English Metallic Bronze	Aged Brass
KNB.905.XX.77A	Split Polished Nickel and Satin Brass with Satin Brass Back Plate		Polished Nickel	Satin Brass
KNB.905.XX.77B	Split Polished Nickel and Satin Brass with Polished Nickel Back Plate		Polished Nickel	Satin Brass

Danbury Knob Split Finish

KNB.905.XX.XX

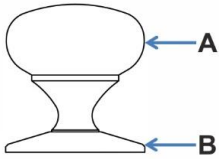
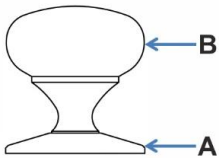
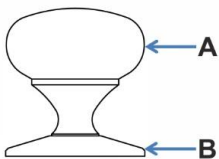
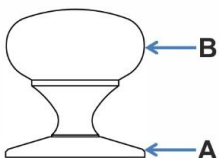
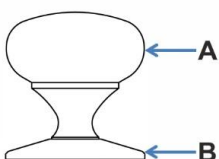
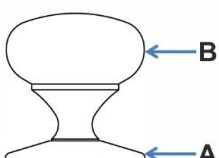
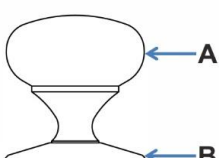
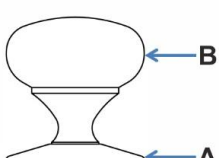
FINISH CODE (XX)	FINISH NAME	LINE DRAWING	A	B
KNB.905.XX.78A	Split Brush Nickel and Satin Brass with Satin Brass Back Plate		Brush Nickel	Satin Brass
KNB.905.XX.78B	Split Brush Nickel and Satin Brass with Brush Nickel Back Plate		Brush Nickel	Satin Brass
KNB.905.XX.80A	Split Oil Rubbed Bronze and Satin Brass with Satin Brass Back Plate		Oil Rubbed Bronze	Satin Brass
KNB.905.XX.80B	Split Oil Rubbed Bronze and Satin Brass with Oil Rubbed Bronze Back Plate		Oil Rubbed Bronze	Satin Brass
KNB.905.XX.90A	Split Graphite and Satin Brass with Satin Brass Back Plate		Graphite	Satin Brass
KNB.905.XX.90B	Split Graphite and Satin Brass with Graphite Back Plate		Graphite	Satin Brass
KNB.905.XX.91A	Split Graphite and Brush Chrome with Brush Chrome Back Plate		Graphite	Brush Chrome
KNB.905.XX.91B	Split Graphite and Brush Chrome with Graphite Back Plate		Graphite	Brush Chrome

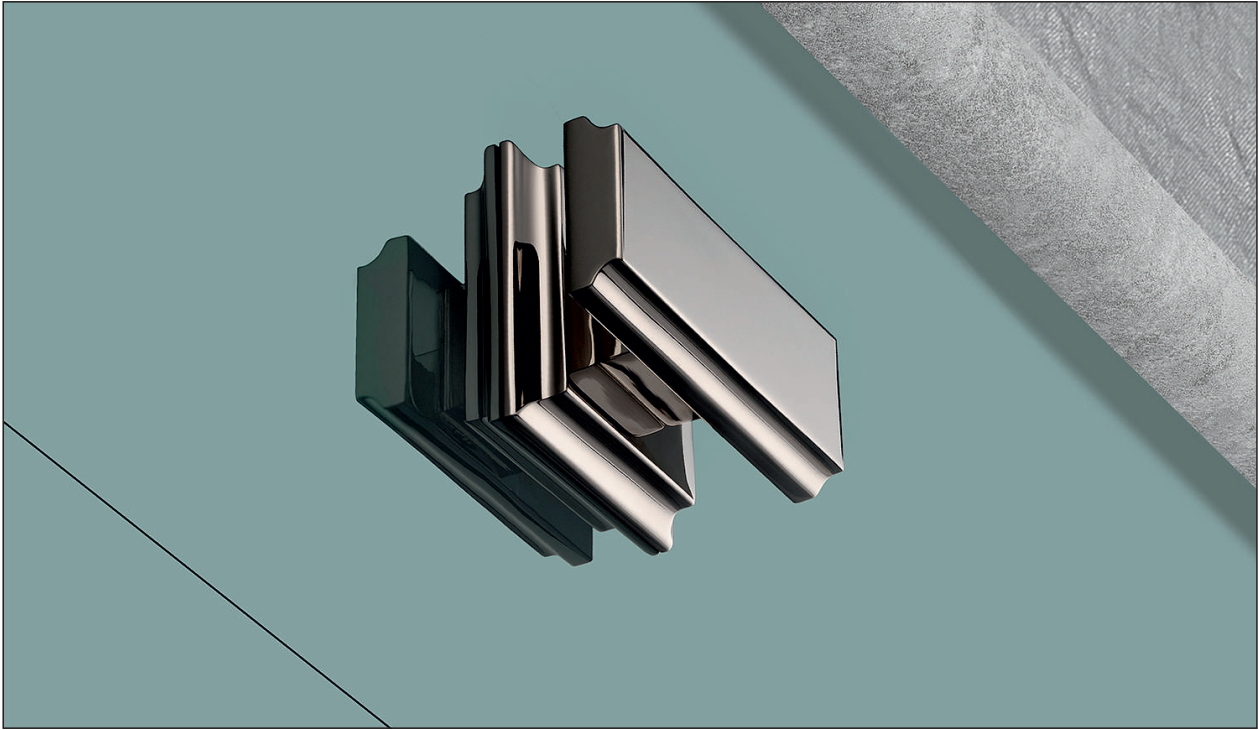

Polished Nickel (Finish ID : 8)

THE GLEBE KNOB

“Glebe with its simple smooth design and concentric grooves could almost be seeking inspiration from the famous Guggenheim Museum in New York.”

Item Code	Size (mm & Inches)	Material	Size (Inches)				Fig.
			A	B	C	D	
1 TKNB.906.55.XX	55mm (2.165")	Brass	0.83	0.93	2.17	1.5	1

"XX" in item code denotes Finish ID.

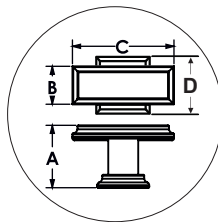

FIG. 1





























This product is Supplied with M4x30mm screws.
This product is Supplied with M4x45mm break off screws.

How to Order

TKNB.906.55.8

T KNOB STYLE : THE GLEBE SIZE DIAMETER : 55 MM FINISH ID : 8

The Glebe Knob Finish Options

Base Material : Brass				Standard Finishes (2-3 Weeks Delivery)		
						
Bright Chrome (Finish ID:2)	Brush Nickel (Finish ID:3)	Aged Brass (Finish ID:4)	Oil Rubbed Bronze (Finish ID:5)	Unlacquered Polished Brass (Finish ID:7U)	Polished Nickel (Finish ID:8)	Satin Brass (Finish ID:13)
Base Material : Brass				Custom Finishes (3-4 Weeks Delivery)*		
						
Lacquered Polished Brass (Finish ID:7L)	Antique Copper (Finish ID:15)	Matte Black (Finish ID:19)	Split Black and Polished Nickel with Polished Nickel Back Plate (Finish ID:48A)	Split Black and Polished Nickel with Black Back Plate (Finish ID:48B)	Split Black and Satin Brass with Satin Brass Back Plate (Finish ID:49A)	Split Black and Satin Brass with Black Back Plate (Finish ID:49B)
						
Split Satin Brass and White with Satin Brass Back Plate (Finish ID:50A)	Split Satin Brass and White with White Back Plate (Finish ID:50B)	English Metallic Bronze (Finish ID:51)	Split Polished Brass and Oil Rubbed Bronze with Polished Brass Back Plate (Finish ID:57A)	Split Polished Brass and Oil Rubbed Bronze with Oil Rubbed Bronze Back Plate (Finish ID:57B)	Split Black and Chrome with Chrome Back Plate (Finish ID:59A)	Split Black and Chrome with Black Back Plate (Finish ID:59B)
						
Split Satin Copper and Oil Rubbed Bronze with Satin Copper Back Plate (Finish ID:60A)	Split Satin Copper and Oil Rubbed Bronze with Oil Rubbed Bronze Back Plate (Finish ID:60B)	Graphite (Finish ID:61)	Split Aged Brass and English Metallic Bronze with Aged Brass Back Plate (Finish ID:75A)	Split Aged Brass and English Metallic Bronze with English Metallic Bronze Back Plate (Finish ID:75B)	Split Polished Nickel and Satin Brass with Satin Brass Back Plate (Finish ID:77A)	Split Polished Nickel and Satin Brass with Polished Nickel Back Plate (Finish ID:77B)

- Custom finishes cannot be returned or refunded. We are unable to accept cancellations for custom finish order unless within 48 hours of the order being placed.
- We have uniform pricing for all non-hammered finishes listed above as long as base material and size is same.
- Contact us for customized finishes, refer pages F1, F2, F3 & F4 for finish glossary.
- Backplate options refer page KBP1-1 to KBP14-1.

Base Material : Brass		Custom Finishes (3-4 Weeks Delivery)*				
 Split Brush Nickel and Satin Brass with Satin Brass Back Plate (Finish ID:78A)	 Split Brush Nickel and Satin Brass with Brush Nickel Back Plate (Finish ID:78B)	 Titanium (Finish ID:79)	 Split Oil Rubbed Bronze And Satin Brass with Satin Brass Back Plate (Finish ID:80A)	 Split Oil Rubbed Bronze And Satin Brass with Oil Rubbed Bronze Back Plate (Finish ID:80B)	 Split Graphite and Satin Brass with Satin Brass Back Plate (Finish ID:90A)	 Split Graphite and Satin Brass with Graphite Back Plate (Finish ID:90B)
 Split Graphite and Brush Chrome with Graphite Back Plate (Finish ID:91A)	 Split Graphite and Brush Chrome with Brush Chrome Back Plate (Finish ID:91B)	 Ombre (Finish ID:92)	 Brush Chrome (Finish ID:95)			

- Custom finishes cannot be returned or refunded. We are unable to accept cancellations for custom finish order unless within 48 hours of the order being placed.
- We have uniform pricing for all non-hammered finishes listed above as long as base material and size is same.
- Contact us for customized finishes, refer pages F1, F2, F3 & F4 for finish glossary.
- Backplate options refer page KBP1-1 to KBP14-1.

The Glebe T Knob Split Finish

TKNB.906.XX.XX

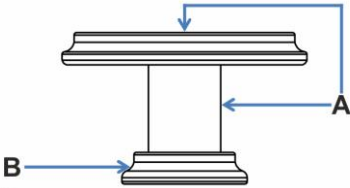
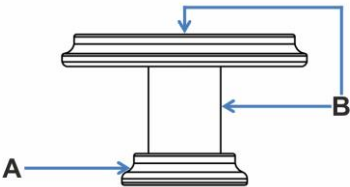
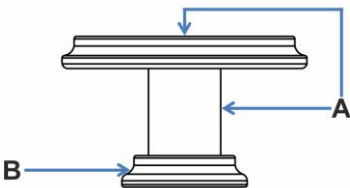
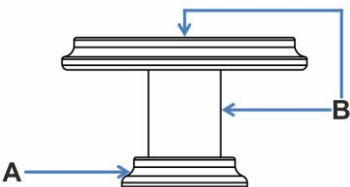
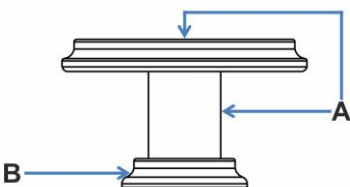
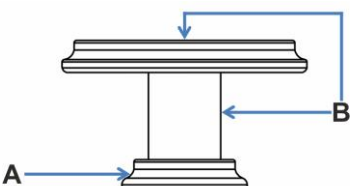
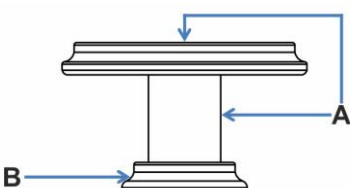
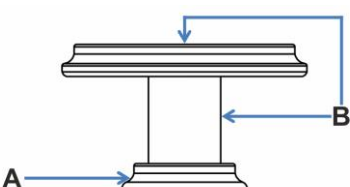
FINISH CODE (XX)	FINISH NAME	LINE DRAWING	A	B
TKNB.906.XX.48A	Split Black and Nickel with Polished Nickel Back Plate		Matte Black	Polished Nickel
TKNB.906.XX.48B	Split Black and Nickel with Black Back Plate		Matte Black	Polished Nickel
TKNB.906.XX.49A	Split Black and Satin Brass with Satin Brass Back Plate		Matte Black	Satin Brass
TKNB.906.XX.49B	Split Black and Satin Brass with Black Back Plate		Matte Black	Satin Brass
TKNB.906.XX.50A	Split Satin Brass and White with Satin Brass Back Plate		White Epoxy	Satin Brass
TKNB.906.XX.50B	Split Satin Brass and White with White Back Plate		White Epoxy	Satin Brass
TKNB.906.XX.57A	Split Lacqured Polished Brass and Oil Rubbed Bronze with Lacqured Polished Brass Back Plate		Oil Rubbed Bronze	Lacqured Polished Brass
TKNB.906.XX.57B	Split Lacqured Polished Brass and Oil Rubbed Bronze with Oil Rubbed Bronze Back Plate		Oil Rubbed Bronze	Lacqured Polished Brass

The Glebe T Knob Split Finish

TKNB.906.XX.XX

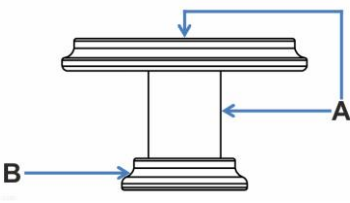
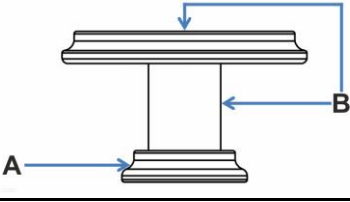
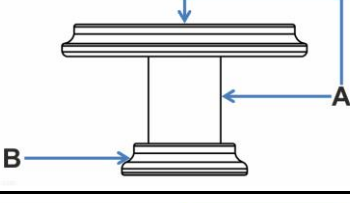
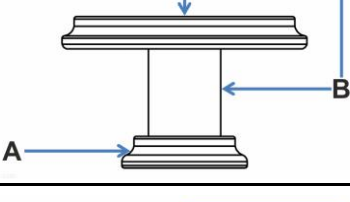
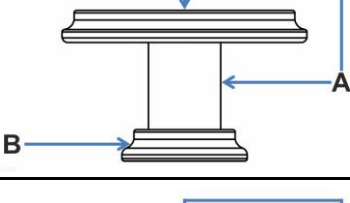
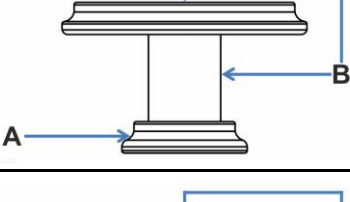
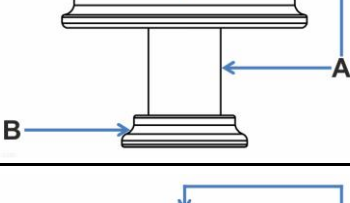
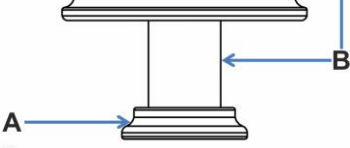
FINISH CODE (XX)	FINISH NAME	LINE DRAWING	A	B
TKNB.906.XX.59A	Split Black and chrome with chrome back plate		Matte Black	Bright Chrome
TKNB.906.XX.59B	Split Black and chrome / Black back plate		Matte Black	Bright Chrome
TKNB.906.XX.60A	Split Satin Copper and Oil Rubbed Bronze with Satin Copper Back Plate		Oil Rubbed Bronze	Satin Copper
TKNB.906.XX.60B	Split Satin Copper and Oil Rubbed Bronze with Oil Rubbed Bronze Back Plate		Oil Rubbed Bronze	Satin Copper
TKNB.906.XX.75A	Split Aged Brass and English Metallic Bronze with Aged Brass Back Plate		English Metallic Bronze	Aged Brass
TKNB.906.XX.75B	Split Aged Brass and English Metallic Bronze with English Metallic Bronze Back Plate		English Metallic Bronze	Aged Brass
TKNB.906.XX.77A	Split Polished Nickel and Satin Brass with Satin Brass Back Plate		Polished Nickel	Satin Brass
TKNB.906.XX.77B	Split Polished Nickel and Satin Brass with Polished Nickel Back Plate		Polished Nickel	Satin Brass

The Glebe T Knob Split Finish

TKNB.906.XX.XX

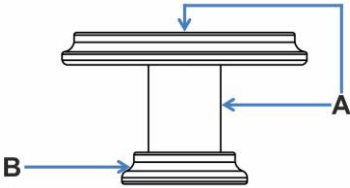
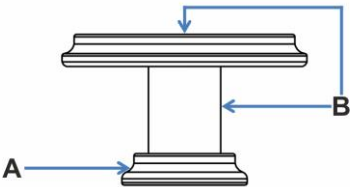
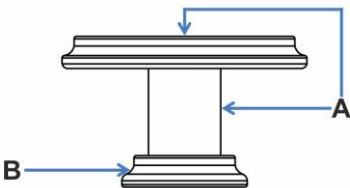
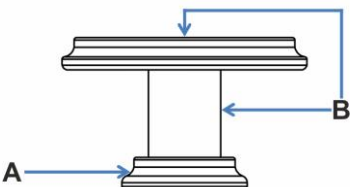
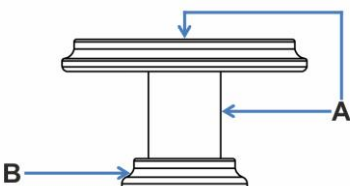
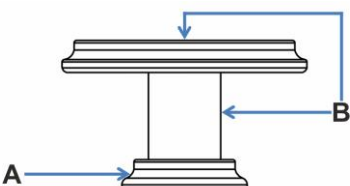
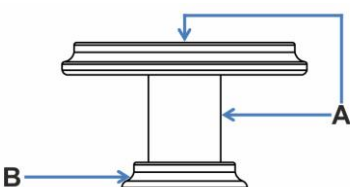
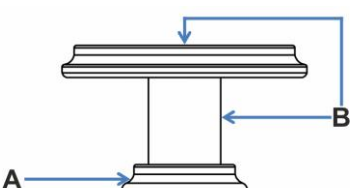
FINISH CODE (XX)	FINISH NAME	LINE DRAWING	A	B
TKNB.906.XX.78A	Split Brush Nickel and Satin Brass with Satin Brass Back Plate		Brush Nickel	Satin Brass
TKNB.906.XX.78B	Split Brush Nickel and Satin Brass with Brush Nickel Back Plate		Brush Nickel	Satin Brass
TKNB.906.XX.80A	Split Oil Rubbed Bronze and Satin Brass with Satin Brass Back Plate		Oil Rubbed Bronze	Satin Brass
TKNB.906.XX.80B	Split Oil Rubbed Bronze and Satin Brass with Oil Rubbed Bronze Back Plate		Oil Rubbed Bronze	Satin Brass
TKNB.906.XX.90A	Split Graphite and Satin Brass with Satin Brass Back Plate		Graphite	Satin Brass
TKNB.906.XX.90B	Split Graphite and Satin Brass with Graphite Back Plate		Graphite	Satin Brass
TKNB.906.XX.91A	Split Graphite and Brush Chrome with Brush Chrome Back Plate		Graphite	Brush Chrome
TKNB.906.XX.91B	Split Graphite and Brush Chrome with Graphite Back Plate		Graphite	Brush Chrome

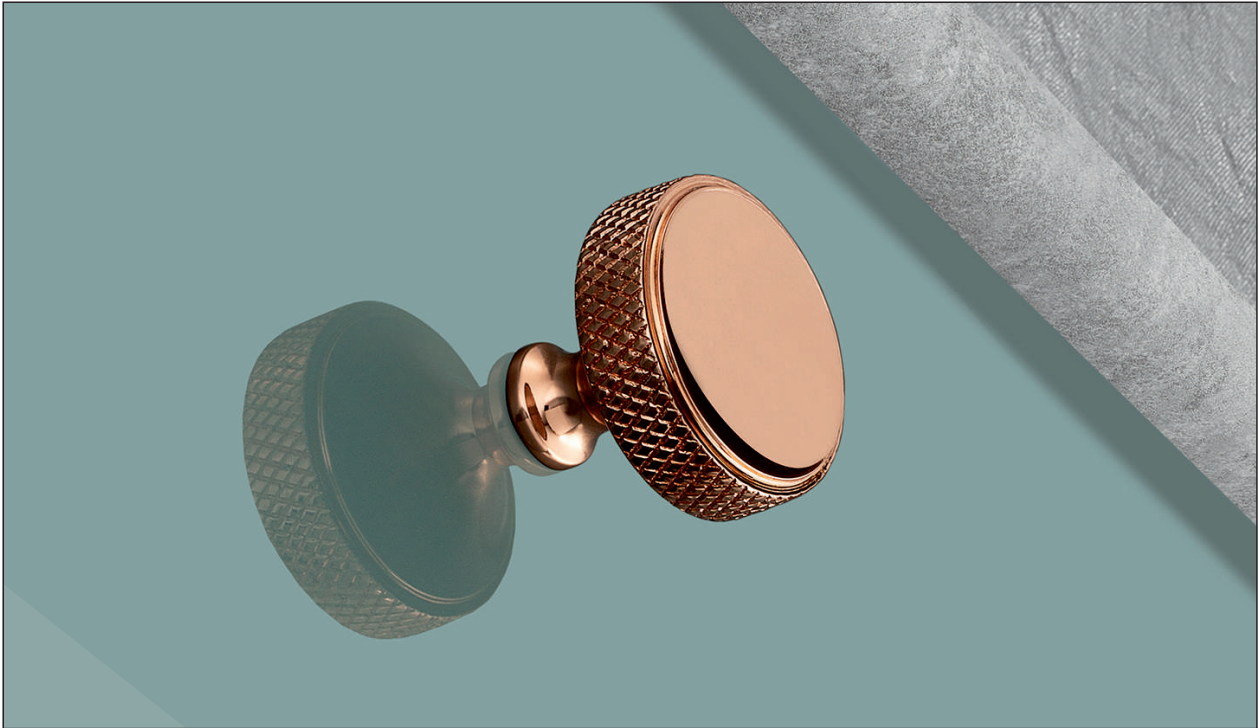

Rose Gold (Finish ID : 33)

HARLEQUIN KNOB

“A Harlequin is defined by its diamond pattern and contrasting colours, the knurled diamond detail features equally well on the more boldly contrasting polished chrome and black or the subtle shades of English metallic bronze and aged brass.”

	Item Code	Size (mm & Inches)	Material	Size (Inches)				Fig.
				A	B	C	D	
1	KNB.912.32.XX	32mm (1.26")	Brass	0.98	1.26	0.49	N/A	1
2	KNB.912.38.XX	38mm (1.5")	Brass	1.14	1.5	0.51	N/A	1

“XX” in item code denotes Finish ID.

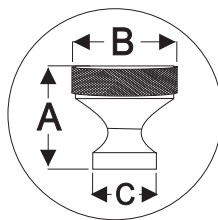

FIG. 1





























This product is Supplied with M4x25mm screws.
This product is Supplied with M4x45mm break off screws.

How to Order

KNB.912.32.33

KNOB STYLE : HARLEQUIN SIZE DIAMETER : 32 MM FINISH ID : 33

Harlequin Knob Finish Options

Base Material : Brass		Standard Finishes (2-3 Weeks Delivery)				
						
Bright Chrome (Finish ID:2)	Brush Nickel (Finish ID:3)	Aged Brass (Finish ID:4)	Oil Rubbed Bronze (Finish ID:5)	Unlacquered Polished Brass (Finish ID:7U)	Polished Nickel (Finish ID:8)	Satin Brass (Finish ID:13)
Base Material : Brass		Custom Finishes (3-4 Weeks Delivery)*				
						
Lacquered Polished Brass (Finish ID:7L)	Antique Copper (Finish ID:15)	Matte Black (Finish ID:19)	Rose Gold (Finish ID:33)	Split Black and Polished Nickel (Finish ID:48)	Split Black and Satin Brass (Finish ID:49)	Split Satin Brass and White (Finish ID:50)
						
English Metallic Bronze (Finish ID:51)	Split Polished Brass And Oil Rubbed Bronze (Finish ID:57)	Split Black And Chrome (Finish ID:59)	Split Satin Copper And Oil Rubbed Bronze (Finish ID:60)	Graphite (Finish ID:61)	Split Aged Brass And English Metallic Bronze (Finish ID:75)	Split Polished Nickel And Satin Brass (Finish ID:77)
						
Split Brush Nickel And Satin Brass (Finish ID:78)	Titanium (Finish ID:79)	Split Oil Rubbed Bronze and Satin Brass (Finish ID:80)	Split Graphite and Satin Brass (Finish ID:90)	Split Graphite and Brush Chrome (Finish ID:91)	Ombre (Finish ID:92)	Brush Chrome (Finish ID:95)

- Custom finishes cannot be returned or refunded. We are unable to accept cancellations for custom finish order unless within 48 hours of the order being placed.
- We have uniform pricing for all non-hammered finishes listed above as long as base material and size is same.
- Contact us for customized finishes, refer pages F1, F2, F3 & F4 for finish glossary.
- Backplate options refer page KBP1-1 to KBP14-1.

Harlequin Knob Split Finish

KNB.912.XX.XX

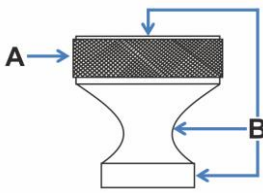
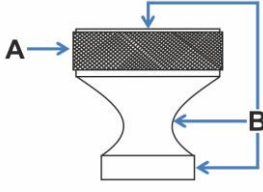
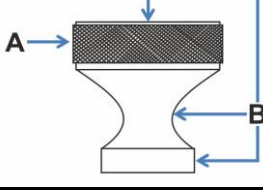
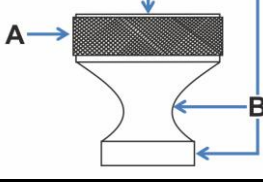
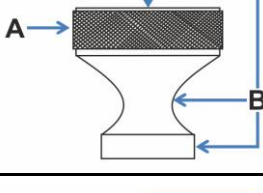
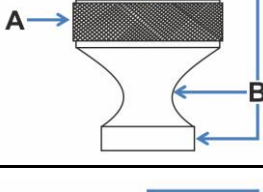
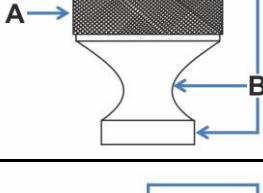
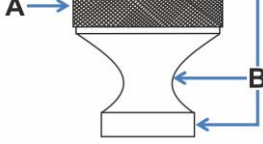
FINISH CODE (XX)	FINISH NAME	LINE DRAWING	A	B
KNB.912.XX.48	Split Black and Polished Nickel		Matte Black	Polished Nickel
KNB.912.XX.49	Split Black and Satin Brass		Matte Black	Satin Brass
KNB.912.XX.50	Split Satin Brass and White		White Epoxy	Satin Brass
KNB.912.XX.57	Split Polished Brass and Oil Rubbed Bronze		Oil Rubbed Bronze	Lacquered Polished Brass
KNB.912.XX.59	Split Black and Chrome		Matte Black	Bright Chrome
KNB.912.XX.60	Split Satin Copper and Oil Rubbed Bronze		Oil Rubbed Bronze	Satin Copper
KNB.912.XX.75	Split Aged Brass and English Metallic Bronze		English Metallic Bronze	Aged Brass
KNB.912.XX.77	Split Polished Nickel and Satin Brass		Satin Brass	Polished Nickel

Harlequin Knob Split Finish

KNB.912.XX.XX

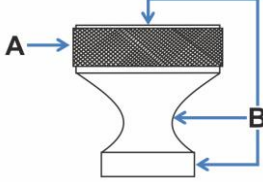
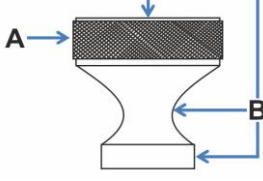
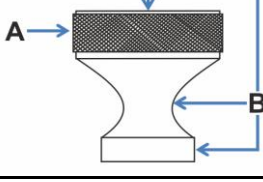
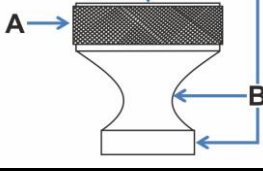
FINISH CODE (XX)	FINISH NAME	LINE DRAWING	A	B
KNB.912.XX.78	Split Brush Nickel and Satin Brass		Brush Nickel	Satin Brass
KNB.912.XX.80	Split Oil Rubbed Bronze and Satin Brass		Oil Rubbed Bronze	Satin Brass
KNB.912.XX.90	Split Graphite and Satin Brass		Graphite	Satin Brass
KNB.912.XX.91	Split Graphite and Brush Chrome		Graphite	Brush Chrome



Brush Nickel (Finish ID : 3)

HARLEQUIN TAPER KNOB

“A Harlequin is defined by its diamond pattern and contrasting colours, the knurled diamond detail features equally well on the more boldly contrasting polished chrome and black or the subtle shades of English metallic bronze and aged brass.”

Item Code	Size (mm & Inches)	Material	Size (Inches)				Fig.
			A	B	C	D	
1 TPRKNB.912.30.XX	30mm (1.18")	Brass	1.38	0.92	1.18	N/A	1

"XX" in item code denotes Finish ID.

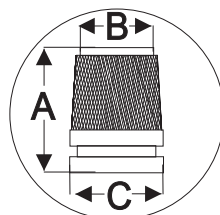

FIG. 1

This product is Supplied with M4x25mm screws.
This product is Supplied with M4x45mm break off screws.

How to Order

TPRKNB.912.30.3

TAPER KNOB STYLE : HARLEQUIN SIZE DIAMETER : 30 MM FINISH ID : 3

Harlequin Taper Knob Finish Options

Base Material : Brass		Standard Finishes (2-3 Weeks Delivery)				
						
Bright Chrome (Finish ID:2)	Brush Nickel (Finish ID:3)	Aged Brass (Finish ID:4)	Oil Rubbed Bronze (Finish ID:5)	Unlacquered Polished Brass (Finish ID:7U)	Polished Nickel (Finish ID:8)	Satin Brass (Finish ID:13)
Base Material : Brass		Custom Finishes (3-4 Weeks Delivery)*				
						
Lacquered Polished Brass (Finish ID:7L)	Antique Copper (Finish ID:15)	Matte Black (Finish ID:19)	English Metallic Bronze (Finish ID:51)	Graphite (Finish ID:61)	Titanium (Finish ID:79)	Ombre (Finish ID:92)
						
Brush Chrome (Finish ID:95)						

- Custom finishes cannot be returned or refunded. We are unable to accept cancellations for custom finish order unless within 48 hours of the order being placed.
- We have uniform pricing for all non-hammered finishes listed above as long as base material and size is same.
- Contact us for customized finishes, refer pages F1, F2, F3 & F4 for finish glossary.
- Backplate options refer page KBP1-1 to KBP14-1.

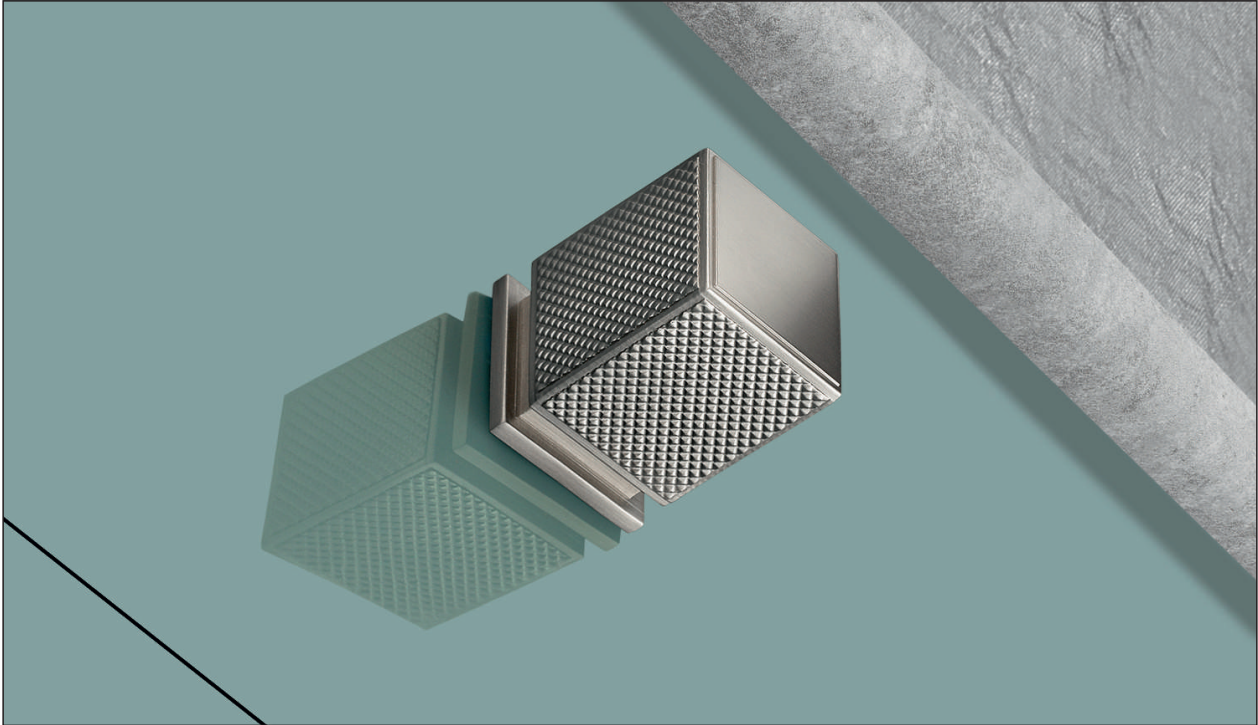

Brush Nickel (Finish ID : 3)

MACHISMO KNOB

“Machismo with its simple smooth design and concentric grooves could almost be seeking inspiration from the famous Guggenheim Museum in New York.”

Item Code	Size (mm & Inches)	Material	Size (Inches)				Fig.
			A	B	C	D	
1 KNB.914.28.XX	28mm (1.10")	Brass	1.5	1.1	1.1	N/A	1

"XX" in item code denotes Finish ID.

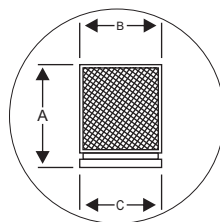

FIG. 1

This product is Supplied with M4x25mm screws.
This product is Supplied with M4x45mm break off screws.

How to Order

KNB.914.28.3

KNOB STYLE : MACHISMO SIZE DIAMETER : 28 MM FINISH ID : 3

Machismo Knob Finish Options

Base Material : Brass		Standard Finishes (2-3 Weeks Delivery)				
						
Bright Chrome (Finish ID:2)	Brush Nickel (Finish ID:3)	Aged Brass (Finish ID:4)	Oil Rubbed Bronze (Finish ID:5)	Unlacquered Polished Brass (Finish ID:7U)	Polished Nickel (Finish ID:8)	Satin Brass (Finish ID:13)
Base Material : Brass		Custom Finishes (3-4 Weeks Delivery)*				
						
Lacquered Polished Brass (Finish ID:7L)	Matte Black (Finish ID:19)	Graphite (Finish ID:61)	Titanium (Finish ID:79)	Ombre (Finish ID:92)	Brush Chrome (Finish ID:95)	

- Custom finishes cannot be returned or refunded. We are unable to accept cancellations for custom finish order unless within 48 hours of the order being placed.
- We have uniform pricing for all non-hammered finishes listed above as long as base material and size is same.
- Contact us for customized finishes, refer pages F1, F2, F3 & F4 for finish glossary.
- Backplate options refer page KBP1-1 to KBP14-1.

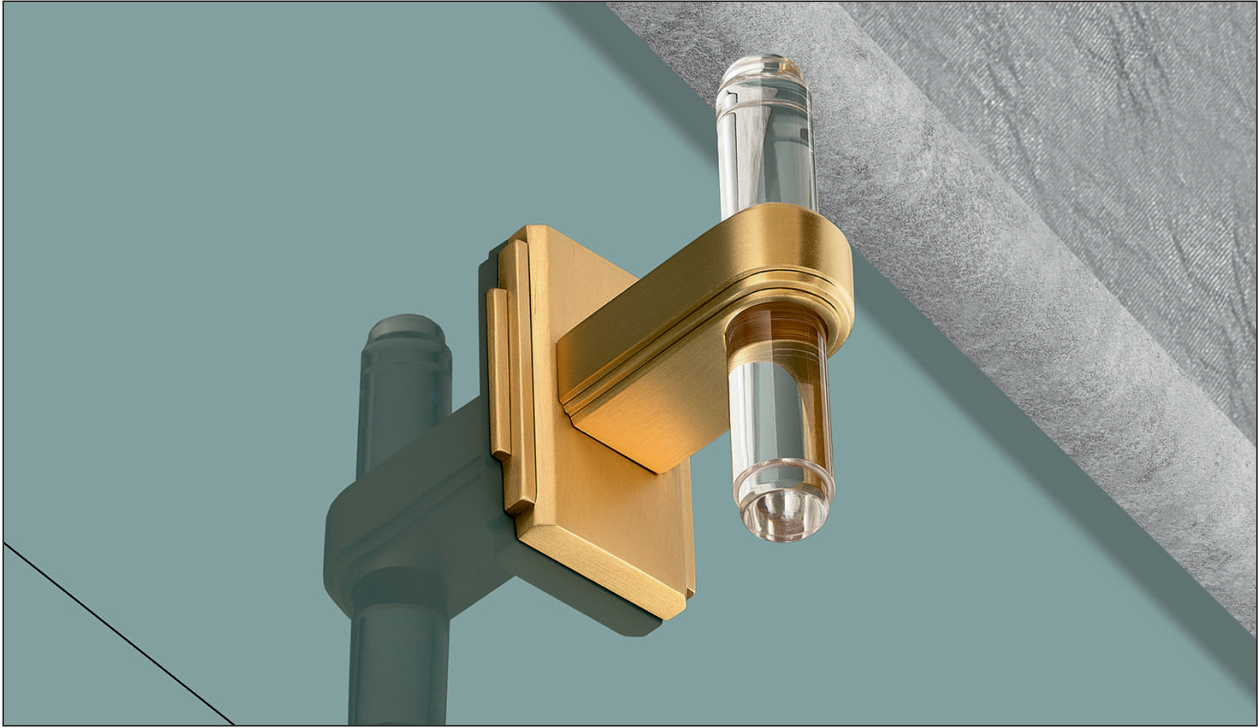

Acrylic/Brush Brass (Finish ID : 73)

LEXINGTON T KNOB

“Mirroring the abstract geometric shapes of the Art Deco buildings that set the tone throughout Manhattans iconic skyline.”

	Item Code	Size (mm & Inches)	Material	Size (Inches)				Fig.
				A	B	C	D	
1	TKNB.916.75.XX	75mm (2.95")	Brass	1.75	2.95	1.34	1.97	1
2	TKNB.916.115.XX	115mm (4.53")	Brass	1.75	4.53	1.34	3.54	1

“XX” in item code denotes Finish ID.

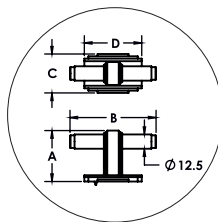

FIG. 1





























This product is Supplied with M4x30mm screws.
This product is Supplied with M4x45mm break off screws.

How to Order

TKNB.916.75.73

T KNOB STYLE : LEXINGTON SIZE DIAMETER : 75 MM FINISH ID : 73

Lexington T Knob Finish Options

Base Material : Brass		Standard Finishes (2-3 Weeks Delivery)				
						
Bright Chrome (Finish ID:2)	Brush Nickel (Finish ID:3)	Aged Brass (Finish ID:4)	Oil Rubbed Bronze (Finish ID:5)	Unlacquered Polished Brass (Finish ID:7U)	Polished Nickel (Finish ID:8)	Satin Brass (Finish ID:13)
Base Material : Brass		Custom Finishes (3-4 Weeks Delivery)*				
						
Lacquered Polished Brass (Finish ID:7L)	Antique Copper (Finish ID:15)	Matte Black (Finish ID:19)	Split Black and Polished Nickel with Polished Nickel Back Plate (Finish ID:48A)	Split Black and Polished Nickel with Black Back Plate (Finish ID:48B)	Split Black and Satin Brass with Satin Brass Back Plate (Finish ID:49A)	Split Black and Satin Brass with Black Back Plate (Finish ID:49B)
						
Split Satin Brass and White with Satin Brass Back Plate (Finish ID:50A)	Split Satin Brass and White with White Back Plate (Finish ID:50B)	English Metallic Bronze (Finish ID:51)	Split Polished Brass and Oil Rubbed Bronze with Polished Brass Back Plate (Finish ID:57A)	Split Polished Brass and Oil Rubbed Bronze with Oil Rubbed Bronze Back Plate (Finish ID:57B)	Split Black and Chrome with Chrome Back Plate (Finish ID:59A)	Split Black and Chrome with Black Back Plate (Finish ID:59B)
						
Split Satin Copper and Oil Rubbed Bronze with Satin Copper Back Plate (Finish ID:60A)	Split Satin Copper and Oil Rubbed Bronze with Oil Rubbed Bronze Back Plate (Finish ID:60B)	Graphite (Finish ID:61)	Split Aged Brass and English Metallic Bronze with Aged Brass Back Plate (Finish ID:75A)	Split Aged Brass and English Metallic Bronze with English Metallic Bronze Back Plate (Finish ID:75B)	Split Polished Nickel and Satin Brass with Satin Brass Back Plate (Finish ID:77A)	Split Polished Nickel and Satin Brass with Polished Nickel Back Plate (Finish ID:77B)

- Custom finishes cannot be returned or refunded. We are unable to accept cancellations for custom finish order unless within 48 hours of the order being placed.
- We have uniform pricing for all non-hammered finishes listed above as long as base material and size is same.
- Contact us for customized finishes, refer pages F1, F2, F3 & F4 for finish glossary.
- Backplate options refer page KBP1-1 to KBP14-1.

Base Material : Brass		Custom Finishes (3-4 Weeks Delivery)*				
						
Split Brush Nickel and Satin Brass with Satin Brass Back Plate (Finish ID:78A)	Split Brush Nickel and Satin Brass with Brush Nickel Back Plate (Finish ID:78B)	Titanium (Finish ID:79)	Split Oil Rubbed Bronze And Satin Brass with Satin Brass Back Plate (Finish ID:80A)	Split Oil Rubbed Bronze And Satin Brass with Oil Rubbed Bronze Back Plate (Finish ID:80B)	Split Graphite and Satin Brass with Satin Brass Back Plate (Finish ID:90A)	Split Graphite and Satin Brass with Graphite Back Plate (Finish ID:90B)
						
Split Graphite and Brush Chrome with Graphite Back Plate (Finish ID:91A)	Split Graphite and Brush Chrome with Brush Chrome Back Plate (Finish ID:91B)	Ombre (Finish ID:92)	Brush Chrome (Finish ID:95)			

- Custom finishes cannot be returned or refunded. We are unable to accept cancellations for custom finish order unless within 48 hours of the order being placed.
- We have uniform pricing for all non-hammered finishes listed above as long as base material and size is same.
- Contact us for customized finishes, refer pages F1, F2, F3 & F4 for finish glossary.
- Backplate options refer page KBP1-1 to KBP14-1.

Lexington T knob With Back Plate Split Finish

TKNB.916.XX.XX

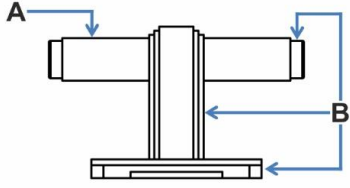
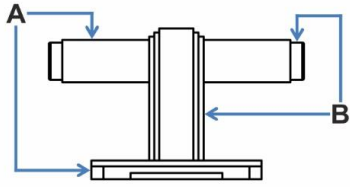
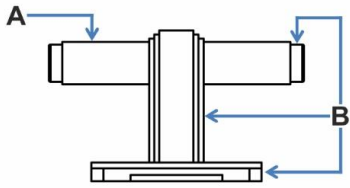
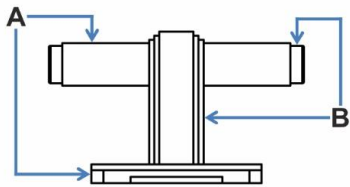
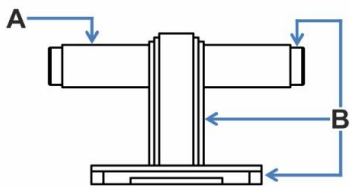
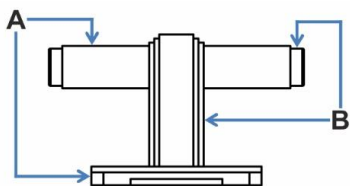
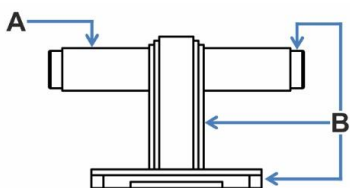
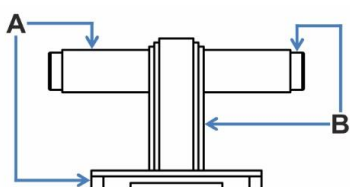
FINISH CODE (XX)	FINISH NAME	LINE DRAWING	A	B
TKNB.916.XX.48A	Split Black and Nickel with Polished Nickel Back Plate		Matte Black	Polished Nickel
TKNB.916.XX.48B	Split Black and Nickel with Black Back Plate		Matte Black	Polished Nickel
TKNB.916.XX.49A	Split Black and Satin Brass with Satin Brass Back Plate		Matte Black	Satin Brass
TKNB.916.XX.49B	Split Black and Satin Brass with Black Back Plate		Matte Black	Satin Brass
TKNB.916.XX.50A	Split Satin Brass and White with Satin Brass Back Plate		White Epoxy	Satin Brass
TKNB.916.XX.50B	Split Satin Brass and White with White Back Plate		White Epoxy	Satin Brass
TKNB.916.XX.57A	Split Lacquered Polished Brass and Oil Rubbed Bronze with Lacquered Polished Brass Back Plate		Oil Rubbed Bronze	Lacquered Polished Brass
TKNB.916.XX.57B	Split Lacquered Polished Brass and Oil Rubbed Bronze with Oil Rubbed Bronze Back Plate		Oil Rubbed Bronze	Lacquered Polished Brass

Lexington T knob With Back Plate Split Finish

TKNB.916.XX.XX

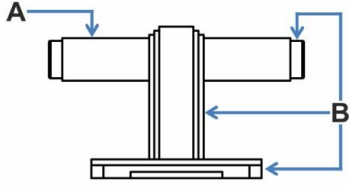
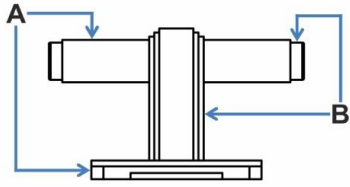
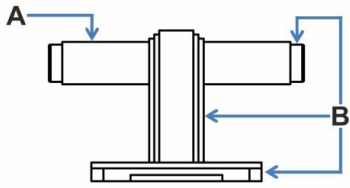
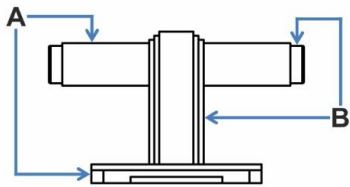
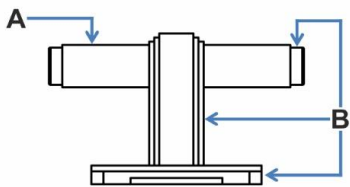
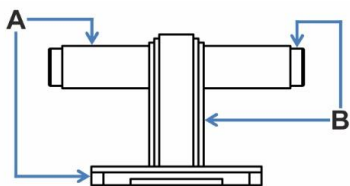
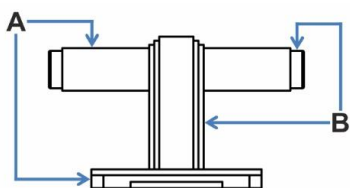
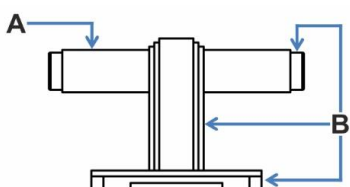
FINISH CODE (XX)	FINISH NAME	LINE DRAWING	A	B
TKNB.916.XX.59A	Split Black and chrome with chrome back plate		Matte Black	Bright Chrome
TKNB.916.XX.59B	Split Black and chrome / Black back plate		Matte Black	Bright Chrome
TKNB.916.XX.60A	Split Satin Copper and Oil Rubbed Bronze with Satin Copper Back Plate		Oil Rubbed Bronze	Satin Copper
TKNB.916.XX.60B	Split Satin Copper and Oil Rubbed Bronze with Oil Rubbed Bronze Back Plate		Oil Rubbed Bronze	Satin Copper
TKNB.916.XX.75A	Split Aged Brass and English Metallic Bronze with Aged Brass Back Plate		English Metallic Bronze	Aged Brass
TKNB.916.XX.75B	Split Aged Brass and English Metallic Bronze with English Metallic Bronze Back Plate		English Metallic Bronze	Aged Brass
TKNB.916.XX.77A	Split Polished Nickel and Satin Brass with Satin Brass Back Plate		Satin Brass	Polished Nickel
TKNB.916.XX.77B	Split Polished Nickel and Satin Brass with Polished Nickel Back Plate		Satin Brass	Polished Nickel

Lexington T knob With Back Plate Split Finish

TKNB.916.XX.XX

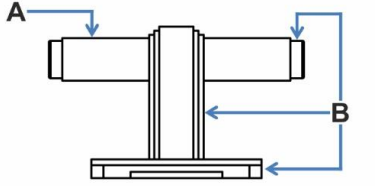
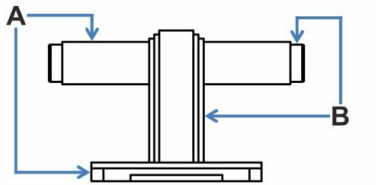
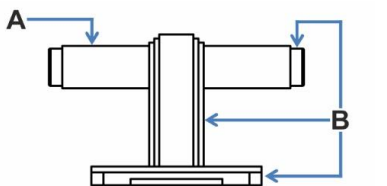
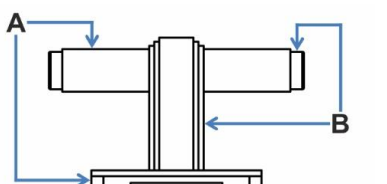
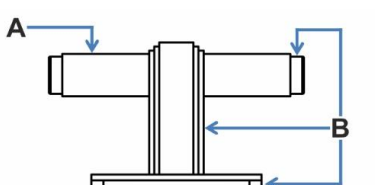
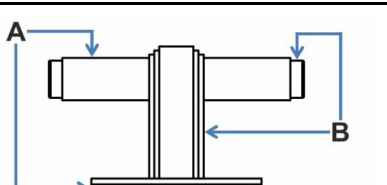
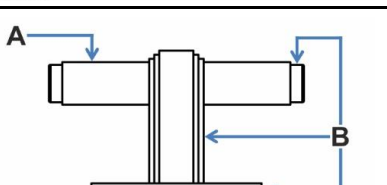
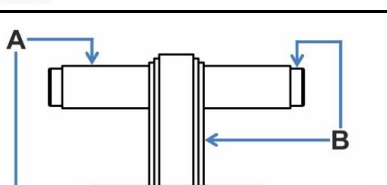
FINISH CODE (XX)	FINISH NAME	LINE DRAWING	A	B
TKNB.916.XX.78A	Split Brush Nickel and Satin Brass with Satin Brass Back Plate		Brush Nickel	Satin Brass
TKNB.916.XX.78B	Split Brush Nickel and Satin Brass with Brush Nickel Back Plate		Brush Nickel	Satin Brass
TKNB.916.XX.80A	Split Oil Rubbed Bronze and Satin Brass with Satin Brass Back Plate		Oil Rubbed Bronze	Satin Brass
TKNB.916.XX.80B	Split Oil Rubbed Bronze and Satin Brass with Oil Rubbed Bronze Back Plate		Oil Rubbed Bronze	Satin Brass
TKNB.916.XX.90A	Split Graphite and Satin Brass with Satin Brass Back Plate		Graphite	Satin Brass
TKNB.916.XX.90B	Split Graphite and Satin Brass with Graphite Back Plate		Graphite	Satin Brass
TKNB.916.XX.91A	Split Graphite and Brush Chrome with Brush Chrome Back Plate		Graphite	Brush Chrome
TKNB.916.XX.91B	Split Graphite and Brush Chrome with Graphite Back Plate		Graphite	Brush Chrome

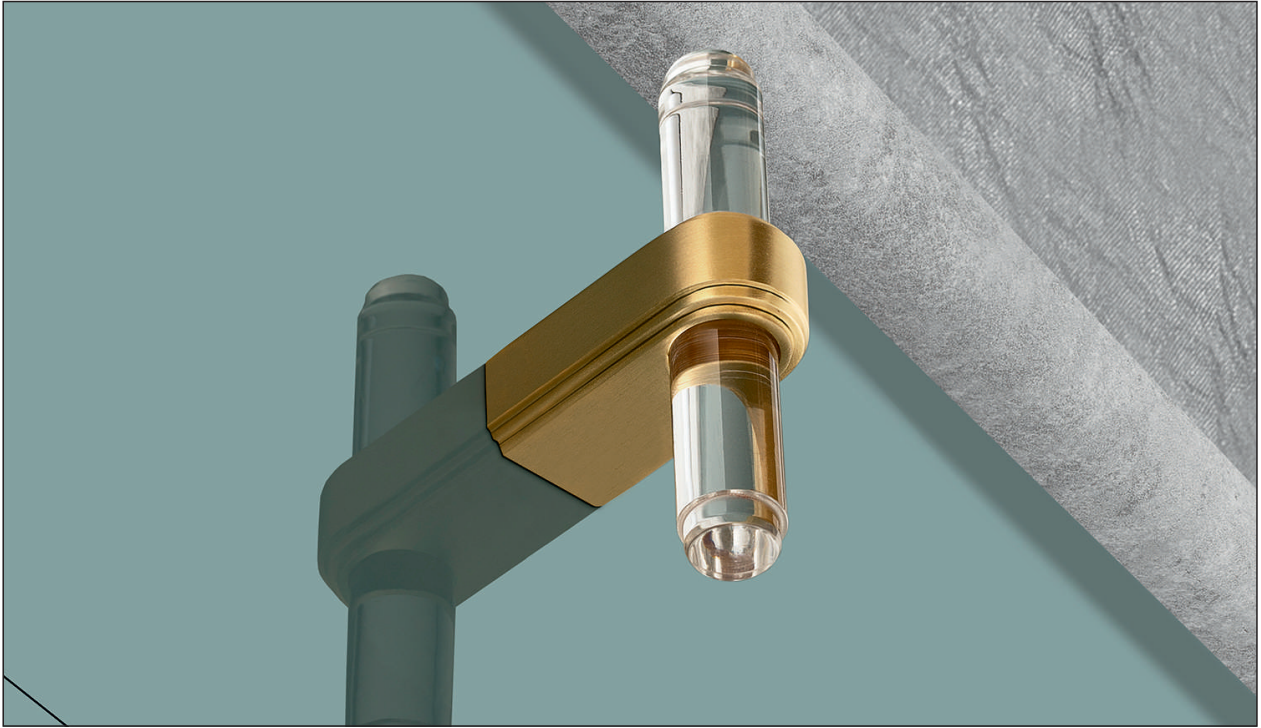

Acrylic/Brush Brass (Finish ID : 73)

LEXINGTON T KNOB WITHOUT BACKPLATE

“Mirroring the abstract geometric shapes of the Art Deco buildings that set the tone throughout Manhattans iconic skyline.”

	Item Code	Size (mm & Inches)	Material	Size (Inches)				Fig.
				A	B	C	D	
1	TKNB.917.75.XX	75mm (2.95")	Brass	1.54	2.95	0.79	N/A	1
2	TKNB.917.115.XX	115mm (4.53")	Brass	1.54	4.53	0.79	N/A	1

“XX” in item code denotes Finish ID.

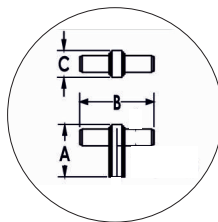

FIG. 1

























This product is Supplied with M4x25mm screws.
This product is Supplied with M4x45mm break off screws.

How to Order

TKNB.917.75.73

T KNOB STYLE : LEXINGTON WITHOUT BACKPLATE SIZE DIAMETER : 75 MM FINISH ID : 73

Lexington T Knob Without Backplate Finish Options

Base Material : Brass		Standard Finishes (2-3 Weeks Delivery)				
						
Bright Chrome (Finish ID:2)	Brush Nickel (Finish ID:3)	Aged Brass (Finish ID:4)	Oil Rubbed Bronze (Finish ID:5)	Unlacquered Polished Brass (Finish ID:7U)	Polished Nickel (Finish ID:8)	Satin Brass (Finish ID:13)
Base Material : Brass		Custom Finishes (3-4 Weeks Delivery)*				
						
Lacquered Polished Brass (Finish ID:7L)	Matte Black (Finish ID:19)	Split Black and Polished Nickel (Finish ID:48)	Split Black and Satin Brass (Finish ID:49)	Split Satin Brass and White (Finish ID:50)	English Metallic Bronze (Finish ID:51)	Split Polished Brass And Oil Rubbed Bronze (Finish ID:57)
						
Split Black And Chrome (Finish ID:59)	Split Satin Copper And Oil Rubbed Bronze (Finish ID:60)	Split Aged Brass And English Metallic Bronze (Finish ID:75)	Split Polished Nickel And Satin Brass (Finish ID:77)	Split Brush Nickel and Satin Brass (Finish ID:78)	Split Oil Rubbed Bronze and Satin Brass (Finish ID:80)	Split Graphite and Satin Brass (Finish ID:90)
						
Split Graphite and Brush Chrome (Finish ID:91)	Ombre (Finish ID:92)	Brush Chrome (Finish ID:95)				

- Custom finishes cannot be returned or refunded. We are unable to accept cancellations for custom finish order unless within 48 hours of the order being placed.
- We have uniform pricing for all non-hammered finishes listed above as long as base material and size is same.
- Contact us for customized finishes, refer pages F1, F2, F3 & F4 for finish glossary.
- Backplate options refer page KBP1-1 to KBP14-1.

Lexington T knob Split Finish

TKNB.917.XX.XX

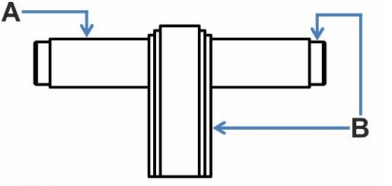
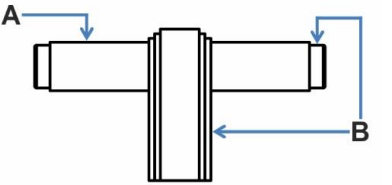
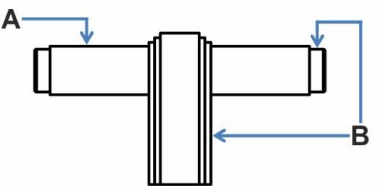
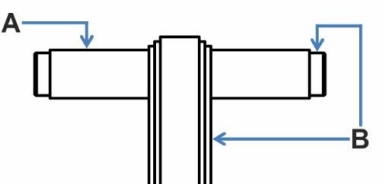
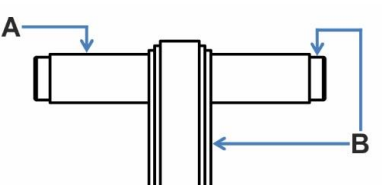
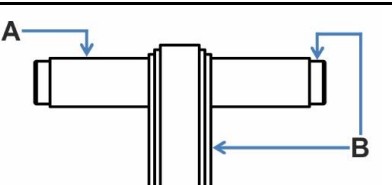
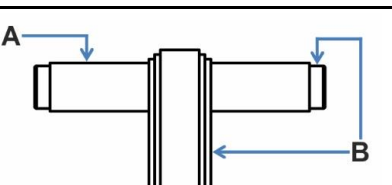
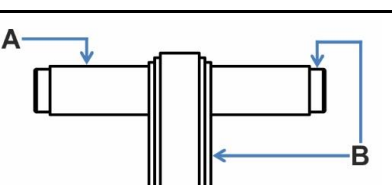
FINISH CODE (XX)	FINISH NAME	LINE DRAWING	A	B
TKNB.917.XX.48	Split Black and Polished Nickel		Matte Black	Polished Nickel
TKNB.917.XX.49	Split Black and Satin Brass		Matte Black	Satin Brass
TKNB.917.XX.50	Split Satin Brass and White		White Epoxy	Satin Brass
TKNB.917.XX.57	Split Polished Brass and Oil Rubbed Bronze		Oil Rubbed Bronze	Lacquered Polished Brass
TKNB.917.XX.59	Split Black and Chrome		Matte Black	Bright Chrome
TKNB.917.XX.60	Split Satin Copper and Oil Rubbed Bronze		Oil Rubbed Bronze	Satin Copper
TKNB.917.XX.75	Split Aged Brass and English Metallic Bronze		English Metallic Bronze	Aged Brass
TKNB.917.XX.77	Split Polished Nickel and Satin Brass		Satin Brass	Polished Nickel

Lexington T knob Split Finish

TKNB.917.XX.XX

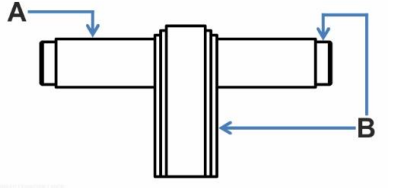
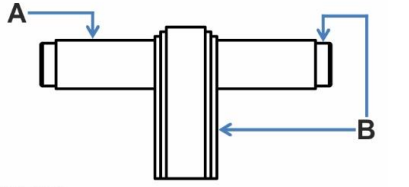
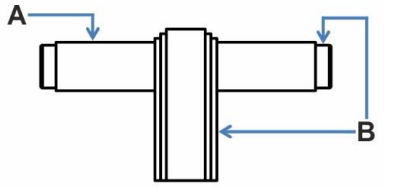
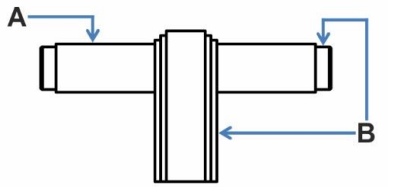
FINISH CODE (XX)	FINISH NAME	LINE DRAWING	A	B
TKNB.917.XX.78	Split Brush Nickel and Satin Brass		Brush Nickel	Satin Brass
KNB.917.XX.80	Split Oil Rubbed Bronze and Satin Brass		Oil Rubbed Bronze	Satin Brass
KNB.917.XX.90	Split Graphite and Satin Brass		Graphite	Satin Brass
TKNB.917.XX.91	Split Graphite and Brush Chrome		Graphite	Brush Chrome

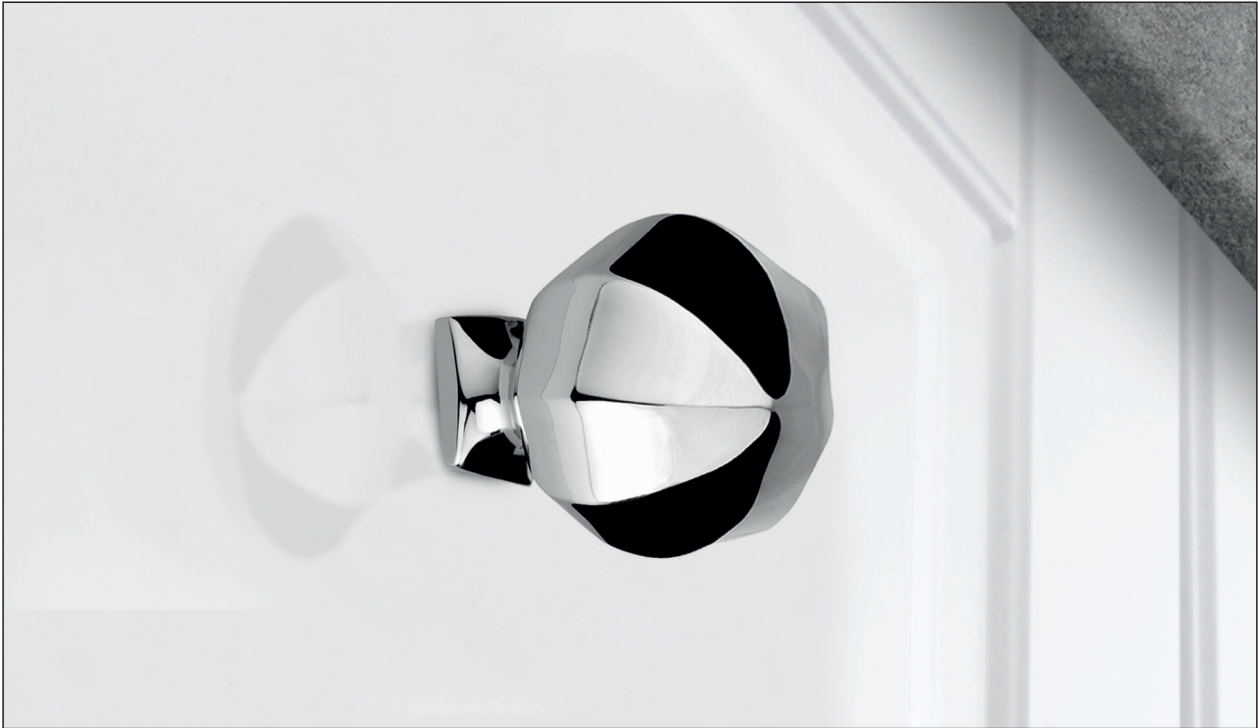

Bright Chrome (Finish ID:2)

MONTICELLO KNOB

	Item Code	Size (mm & Inches)	Material	Size (Inches)				Fig.
				A	B	C	D	
1	KNB.775.25.XX	25mm (0.98")	Brass	1.48	1.02	0.62	N/A	1
2	KNB.775.32.XX	32mm (1.26")	Brass	1.93	1.26	0.85	N/A	1
3	KNB.775.25.XX	25mm (0.98")	Cast Iron	1.48	1.02	0.62	N/A	1
4	KNB.775.32.XX	32mm (1.26")	Cast Iron	1.93	1.26	0.85	N/A	1
5	KNB.775.25.XX	25mm (0.98")	Bronze	1.48	1.02	0.62	N/A	1
6	KNB.775.32.XX	32mm (1.26")	Bronze	1.93	1.26	0.85	N/A	1

"XX" in item code denotes Finish ID.

This product is Supplied with M4x25mm screws.
This product is Supplied with M4x45mm break off screws.

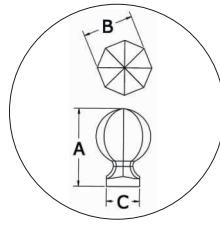

FIG. 1

How to Order

KNB.775.25.2

KNOB STYLE : MONTICELLO SIZE DIAMETER : 25 MM FINISH ID : 2

Monticello Knob Finish Options

Base Material : Cast Iron		Custom Finishes (3-4 Weeks Delivery)*				
 <p>Pewter (Finish ID:1)</p>						
Base Material : Brass		Standard Finishes (2-3 Weeks Delivery)				
 <p>Bright Chrome (Finish ID:2)</p>	 <p>Brush Nickel (Finish ID:3)</p>	 <p>Aged Brass (Finish ID:4)</p>	 <p>Oil Rubbed Bronze (Finish ID:5)</p>	 <p>Unlacquered Polished Brass (Finish ID:7U)</p>	 <p>Polished Nickel (Finish ID:8)</p>	 <p>Satin Brass (Finish ID:13)</p>
Base Material : Brass		Custom Finishes (3-4 Weeks Delivery)*				
 <p>Lacquered Polished Brass (Finish ID:7L)</p>	 <p>Matte Black (Finish ID:19)</p>	 <p>Split Black and Polished Nickel (Finish ID:48)</p>	 <p>Split Black and Satin Brass (Finish ID:49)</p>	 <p>Split Satin Brass and White (Finish ID:50)</p>	 <p>English Metallic Bronze (Finish ID:51)</p>	 <p>Split Polished Brass And Oil Rubbed Bronze (Finish ID:57)</p>

- Custom finishes cannot be returned or refunded. We are unable to accept cancellations for custom finish order unless within 48 hours of the order being placed.
- We have uniform pricing for all non-hammered finishes listed above as long as base material and size is same.
- Contact us for customized finishes, refer pages F1, F2, F3 & F4 for finish glossary.
- Backplate options refer page KBP1-1 to KBP14-1.

Base Material : Brass		Custom Finishes (3-4 Weeks Delivery)*				
						
Split Black And Chrome (Finish ID:59)	Split Satin Copper and Oil Rubbed Bronze with Satin Copper Back Plate (Finish ID:60A)	Graphite (Finish ID:61)	Split Aged Brass And English Metallic Bronze (Finish ID:75)	Split Polished Nickel And Satin Brass (Finish ID:77)	Split Brush Nickel and Satin Brass (Finish ID:78)	Split Oil Rubbed Bronze and Satin Brass (Finish ID:80)
						
Split Graphite and Satin Brass (Finish ID:90)	Split Graphite and Brush Chrome (Finish ID:91)	Ombre (Finish ID:92)	Brush Chrome (Finish ID:95)			
Base Material : Bronze		Custom Finishes (3-4 Weeks Delivery)*				
						
Silicon Bronze Light (Finish ID:53)	Silicon Bronze Dark (Finish ID:53D)	White Bronze (Finish ID:54)				

- Custom finishes cannot be returned or refunded. We are unable to accept cancellations for custom finish order unless within 48 hours of the order being placed.
- We have uniform pricing for all non-hammered finishes listed above as long as base material and size is same.
- Contact us for customized finishes, refer pages F1, F2, F3 & F4 for finish glossary.
- Backplate options refer page KBP1-1 to KBP14-1.

Monticello Knob Split Finish

KNB.775.XX.XX

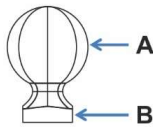
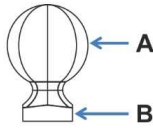
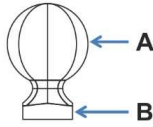
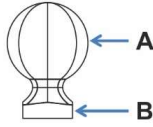
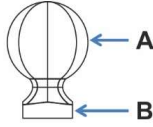
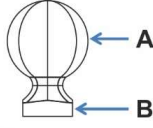
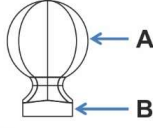
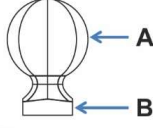
FINISH CODE (XX)	FINISH NAME	LINE DRAWING	A	B
KNB.775.XX.48	Split Black and Polished Nickel		Matte Black	Polished Nickel
KNB.775.XX.49	Split Black and Satin Brass		Matte Black	Satin Brass
KNB.775.XX.50	Split Satin Brass and White		White Epoxy	Satin Brass
KNB.775.XX.57	Split Polished Brass and Oil Rubbed Bronze		Oil Rubbed Bronze	Lacquered Polished Brass
KNB.775.XX.59	Split Black and Chrome		Matte Black	Bright Chrome
KNB.775.XX.60	Split Satin Copper and Oil Rubbed Bronze		Oil Rubbed Bronze	Satin Copper
KNB.775.XX.75	Split Aged Brass and English Metallic Bronze		English Metallic Bronze	Aged Brass
KNB.775.XX.77	Split Polished Nickel and Satin Brass		Satin Brass	Polished Nickel

Monticello Knob Split Finish

KNB.775.XX.XX

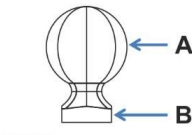
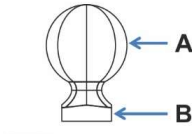
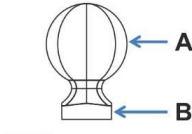
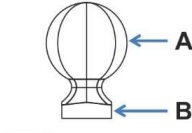
FINISH CODE (XX)	FINISH NAME	LINE DRAWING	A	B
KNB.775.XX.78	Split Brush Nickel and Satin Brass		Brush Nickel	Satin Brass
KNB.775.XX.80	Split Oil Rubbed Bronze and Satin Brass		Oil Rubbed Bronze	Satin Brass
KNB.775.XX.90	Split Graphite and Satin Brass		Graphite	Satin Brass
KNB.775.XX.91	Split Graphite and Brush Chrome		Graphite	Brush Chrome

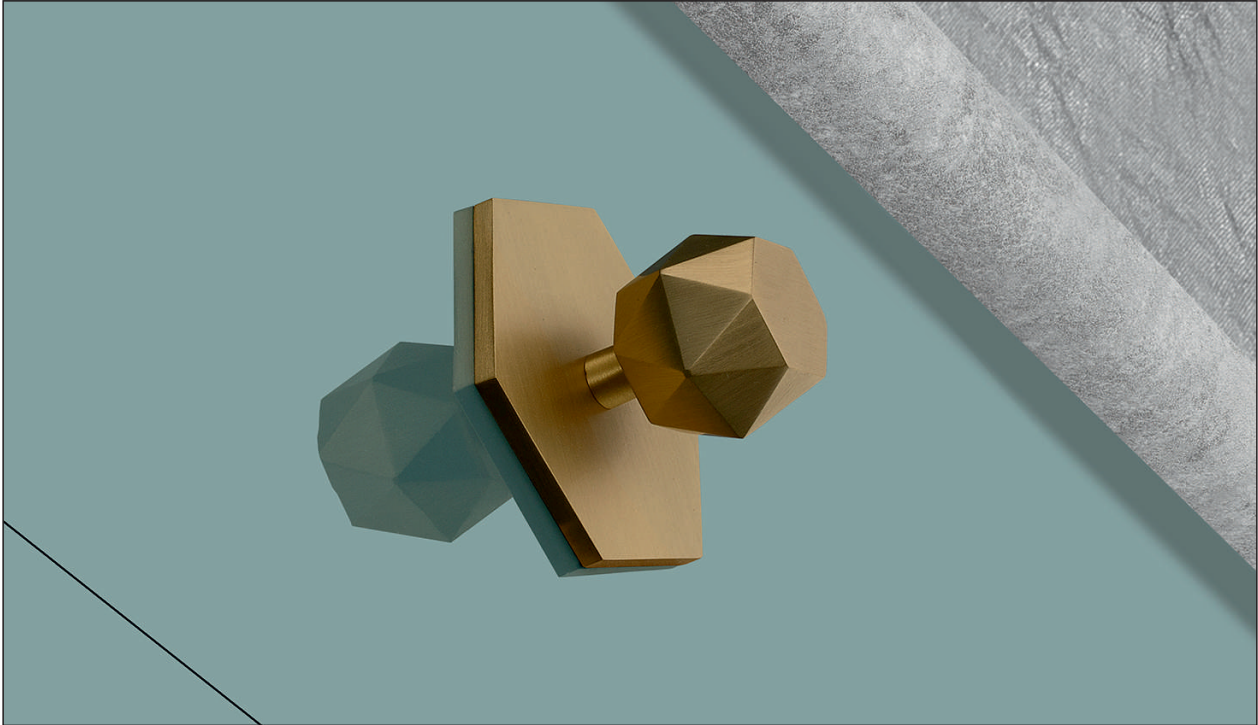

Satin Brass (Finish ID : 13)

ALBEMARLE KNOB WITH BACK PLATE

“The hexagonal shape of the knob allied to the precise faceted back plate give the suggestion of a rose opening in the summer sun. Polished nickel reflects light like a prism while aged brass absorbs light accentuating the faceted detail.”

	Item Code	Size (mm & Inches)	Material	Size (Inches)				Fig.
				A	B	C	D	
1	KNB.915.32.XX	32mm (1.26")	Brass	1.73	1.26	2.5	N/A	1
2	KNB.915.38.XX	38mm (1.5")	Brass	1.9	1.5	2.99	N/A	1

"XX" in item code denotes Finish ID.

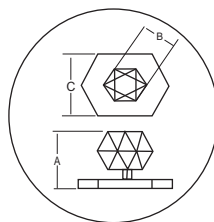

FIG. 1





























This product is Supplied with M4x30mm screws.
This product is Supplied with M4x45mm break off screws.

How to Order

KNB.915.32.13

KNOB STYLE : ALBEMARLE WITH BACK PLATE SIZE DIAMETER : 32 MM FINISH ID : 13

Albemarle Knob With Back Plate Finish Options

Base Material : Brass		Standard Finishes (2-3 Weeks Delivery)				
						
Bright Chrome (Finish ID:2)	Brush Nickel (Finish ID:3)	Aged Brass (Finish ID:4)	Oil Rubbed Bronze (Finish ID:5)	Unlacquered Polished Brass (Finish ID:7U)	Polished Nickel (Finish ID:8)	Satin Brass (Finish ID:13)
Base Material : Brass		Custom Finishes (3-4 Weeks Delivery)*				
						
Lacquered Polished Brass (Finish ID:7L)	Antique Copper (Finish ID:15)	Matte Black (Finish ID:19)	Rose Gold (Finish ID:33)	Split Black and Polished Nickel with Polished Nickel Back Plate (Finish ID:48A)	Split Black and Polished Nickel with Black Back Plate (Finish ID:48B)	Split Black and Satin Brass with Satin Brass Back Plate (Finish ID:49A)
						
Split Black and Satin Brass with Black Back Plate (Finish ID:49B)	Split Satin Brass and White with Satin Brass Back Plate (Finish ID:50A)	Split Satin Brass and White with White Back Plate (Finish ID:50B)	English Metallic Bronze (Finish ID:51)	Split Polished Brass and Oil Rubbed Bronze with Polished Brass Back Plate (Finish ID:57A)	Split Polished Brass and Oil Rubbed Bronze with Oil Rubbed Bronze Back Plate (Finish ID:57B)	Split Black and Chrome with Chrome Back Plate (Finish ID:59A)
						
Split Black and Chrome with Black Back Plate (Finish ID:59B)	Split Satin Copper and Oil Rubbed Bronze with Satin Copper Back Plate (Finish ID:60A)	Split Satin Copper and Oil Rubbed Bronze with Oil Rubbed Bronze Back Plate (Finish ID:60B)	Graphite (Finish ID:61)	Split Aged Brass and English Metallic Bronze with Aged Brass Back Plate (Finish ID:75A)	Split Aged Brass and English Metallic Bronze with English Metallic Bronze Back Plate (Finish ID:75B)	Split Polished Nickel and Satin Brass with Satin Brass Back Plate (Finish ID:77A)

- Custom finishes cannot be returned or refunded. We are unable to accept cancellations for custom finish order unless within 48 hours of the order being placed.
- We have uniform pricing for all non-hammered finishes listed above as long as base material and size is same.
- Contact us for customized finishes, refer pages F1, F2, F3 & F4 for finish glossary.
- Backplate options refer page KBP1-1 to KBP14-1.

Base Material : Brass			Custom Finishes (3-4 Weeks Delivery)*			
 Split Polished Nickel and Satin Brass with Polished Nickel Back Plate (Finish ID:77B)	 Split Brush Nickel and Satin Brass with Satin Brass Back Plate (Finish ID:78A)	 Split Brush Nickel and Satin Brass with Brush Nickel Back Plate (Finish ID:78B)	 Titanium (Finish ID:79)	 Split Oil Rubbed Bronze And Satin Brass with Satin Brass Back Plate (Finish ID:80A)	 Split Oil Rubbed Bronze And Satin Brass with Oil Rubbed Bronze Back Plate (Finish ID:80B)	 Split Graphite and Satin Brass with Satin Brass Back Plate (Finish ID:90A)
 Split Graphite and Satin Brass with Graphite Back Plate (Finish ID:90B)	 Split Graphite and Brush Chrome with Graphite Back Plate (Finish ID:91A)	 Split Graphite and Brush Chrome with Brush Chrome Back Plate (Finish ID:91B)	 Ombre (Finish ID:92)	 Brush Chrome (Finish ID:95)		

- Custom finishes cannot be returned or refunded. We are unable to accept cancellations for custom finish order unless within 48 hours of the order being placed.
- We have uniform pricing for all non-hammered finishes listed above as long as base material and size is same.
- Contact us for customized finishes, refer pages F1, F2, F3 & F4 for finish glossary.
- Backplate options refer page KBP1-1 to KBP14-1.

Albemarle Knob With Back Plate Split Finish

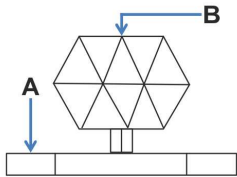
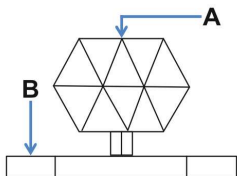
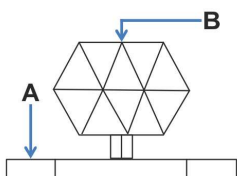
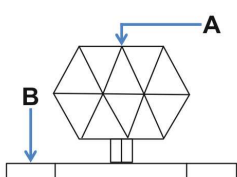
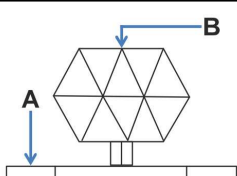
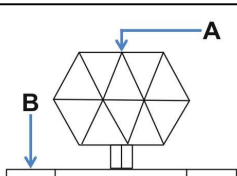
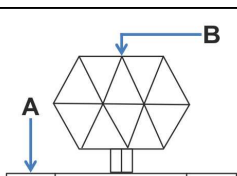
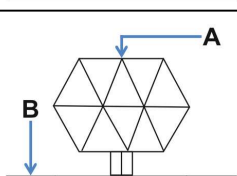
KNB.915.XX.XX				
FINISH CODE (XX)	FINISH NAME	LINE DRAWING	A	B
KNB.915.XX.48A	Split Black and Nickel with Polished Nickel Back Plate		Matte Black	Polished Nickel
KNB.915.XX.48B	Split Black and Nickel with Black Back Plate		Matte Black	Polished Nickel
KNB.915.XX.49A	Split Black and Satin Brass with Satin Brass Back Plate		Matte Black	Satin Brass
KNB.915.XX.49B	Split Black and Satin Brass with Black Back Plate		Matte Black	Satin Brass
KNB.915.XX.50A	Split Satin Brass and White with Satin Brass Back Plate		White Epoxy	Satin Brass
KNB.915.XX.50B	Split Satin Brass and White with White Back Plate		White Epoxy	Satin Brass
KNB.915.XX.57A	Split Lacqured Polished Brass and Oil Rubbed Bronze with Lacqured Polished Brass Back Plate		Oil Rubbed Bronze	Lacqured Polished Brass
KNB.915.XX.57B	Split Lacqured Polished Brass and Oil Rubbed Bronze with Oil Rubbed Bronze Back Plate		Oil Rubbed Bronze	Lacqured Polished Brass

Albemarle Knob With Back Plate Split Finish

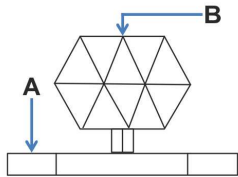
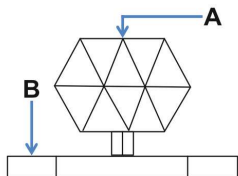
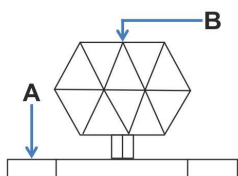
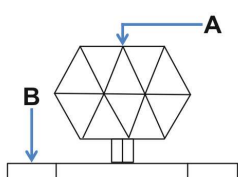
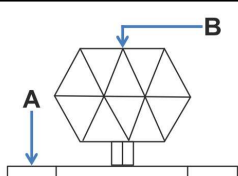
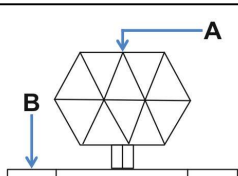
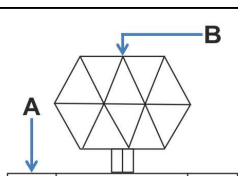
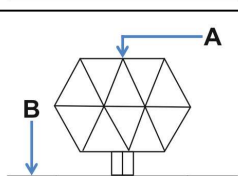
KNB.915.XX.XX				
FINISH CODE (XX)	FINISH NAME	LINE DRAWING	A	B
KNB.915.XX.59A	Split Black and chrome with chrome back plate		Matte Black	Bright Chrome
KNB.915.XX.59B	Split Black and chrome / Black back plate		Matte Black	Bright Chrome
KNB.915.XX.60A	Split Satin Copper and Oil Rubbed Bronze with Satin Copper Back Plate		Oil Rubbed Bronze	Satin Copper
KNB.915.XX.60B	Split Satin Copper and Oil Rubbed Bronze with Oil Rubbed Bronze Back Plate		Oil Rubbed Bronze	Satin Copper
KNB.915.XX.75A	Split Aged Brass and English Metallic Bronze with Aged Brass Back Plate		English Metallic Bronze	Aged Brass
KNB.915.XX.75B	Split Aged Brass and English Metallic Bronze with English Metallic Bronze Back Plate		English Metallic Bronze	Aged Brass
KNB.915.XX.77A	Split Polished Nickel and Satin Brass with Satin Brass Back Plate		Polished Nickel	Satin Brass
KNB.915.XX.77B	Split Polished Nickel and Satin Brass with Polished Nickel Back Plate		Polished Nickel	Satin Brass

Albemarle Knob With Back Plate Split Finish

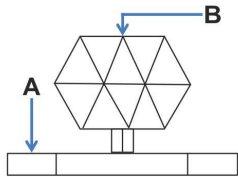
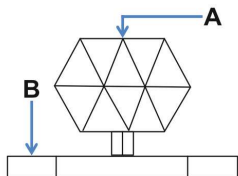
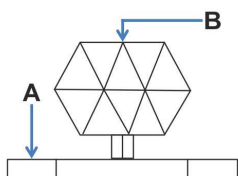
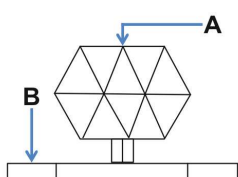
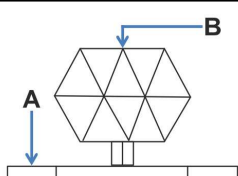
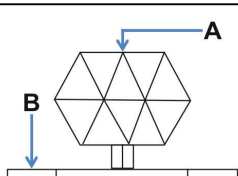
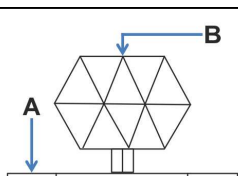
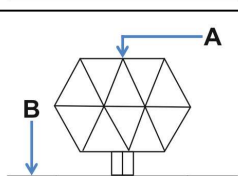
KNB.915.XX.XX				
FINISH CODE (XX)	FINISH NAME	LINE DRAWING	A	B
KNB.915.XX.78A	Split Brush Nickel and Satin Brass with Satin Brass Back Plate		Brush Nickel	Satin Brass
KNB.915.XX.78B	Split Brush Nickel and Satin Brass with Brush Nickel Back Plate		Brush Nickel	Satin Brass
KNB.915.XX.80A	Split Oil Rubbed Bronze and Satin Brass with Satin Brass Back Plate		Oil Rubbed Bronze	Satin Brass
KNB.915.XX.80B	Split Oil Rubbed Bronze and Satin Brass with Oil Rubbed Bronze Back Plate		Oil Rubbed Bronze	Satin Brass
KNB.915.XX.90A	Split Graphite and Satin Brass with Satin Brass Back Plate		Graphite	Satin Brass
KNB.915.XX.90B	Split Graphite and Satin Brass with Graphite Back Plate		Graphite	Satin Brass
KNB.915.XX.91A	Split Graphite and Brush Chrome with Graphite Back Plate		Brush Chrome	Graphite
KNB.915.XX.91B	Split Graphite and Brush Chrome with Brush Chrome Back Plate		Brush Chrome	Graphite



Split Aged Brass and English Metallic Bronze with English Metallic Bronze Back Plate (Finish ID:75B)

HARLEQUIN KNOB WITH BACK PLATE

“A Harlequin is defined by its diamond pattern and contrasting colours, the knurled diamond detail features equally well on the more boldly contrasting polished chrome and black or the subtle shades of English metallic bronze and aged brass.”

Item Code	Size (mm & Inches)	Material	Size (Inches)				Fig.
			A	B	C	D	
1 KNB.918.32x96.XX	32X96mm (1.26"X3.78")	Brass	0.98	1.26	0.98	4.8	1
2 KNB.918.32x128.XX	32X128mm (1.26"X5.04")	Brass	0.98	1.26	0.98	6.06	1
3 KNB.918.32x160.XX	32X160mm (1.26"X6.30")	Brass	0.98	1.26	0.98	7.32	1
4 KNB.918.32x192.XX	32X192mm (1.26"X7.56")	Brass	0.98	1.26	0.98	8.58	1
5 KNB.918.38x96.XX	38X96mm (1.5"X3.78")	Brass	1.26	1.50	1.26	4.8	1
6 KNB.918.38x128.XX	38X128mm (1.5"X5.04")	Brass	1.26	1.50	1.26	6.06	1
7 KNB.918.38x160.XX	38X160mm (1.5"X6.30")	Brass	1.26	1.50	1.26	7.32	1
8 KNB.918.38x192.XX	38X192mm (1.5"X7.56")	Brass	1.26	1.50	1.26	8.58	1

"XX" in item code denotes Finish ID.

This product is Supplied with M4x30mm screws.
This product is Supplied with M4x45mm break off screws.

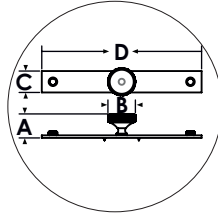

FIG. 1

How to Order

KNB.918.32X96.75B

KNOB STYLE : HARLEQUIN WITH BACK PLATE SIZE DIAMETER : 32X96 MM FINISH ID : 75B

Harlequin Knob With Back Plate Finish Options

Base Material : Brass		Standard Finishes (2-3 Weeks Delivery)				
						
Bright Chrome (Finish ID:2)	Brush Nickel (Finish ID:3)	Aged Brass (Finish ID:4)	Oil Rubbed Bronze (Finish ID:5)	Unlacquered Polished Brass (Finish ID:7U)	Polished Nickel (Finish ID:8)	Satin Brass (Finish ID:13)
Base Material : Brass		Custom Finishes (3-4 Weeks Delivery)*				
						
Lacquered Polished Brass (Finish ID:7L)	Antique Copper (Finish ID:15)	Matte Black (Finish ID:19)	Rose Gold (Finish ID:33)	Split Black and Polished Nickel with Polished Nickel Back Plate (Finish ID:48A)	Split Black and Polished Nickel with Black Back Plate (Finish ID:48B)	Split Black and Satin Brass with Satin Brass Back Plate (Finish ID:49A)
						
Split Black and Satin Brass with Black Back Plate (Finish ID:49B)	Split Satin Brass and White with Satin Brass Back Plate (Finish ID:50A)	Split Satin Brass and White with White Back Plate (Finish ID:50B)	English Metallic Bronze (Finish ID:51)	Split Polished Brass and Oil Rubbed Bronze with Polished Brass Back Plate (Finish ID:57A)	Split Polished Brass and Oil Rubbed Bronze with Oil Rubbed Bronze Back Plate (Finish ID:57B)	Split Black and Chrome with Chrome Back Plate (Finish ID:59A)

- Custom finishes cannot be returned or refunded. We are unable to accept cancellations for custom finish order unless within 48 hours of the order being placed.
- We have uniform pricing for all non-hammered finishes listed above as long as base material and size is same.
- Contact us for customized finishes, refer pages F1, F2, F3 & F4 for finish glossary.
- Backplate options refer page KBP1-1 to KBP14-1.

Base Material : Brass			Custom Finishes (3-4 Weeks Delivery)*			
						
Split Black and Chrome with Black Back Plate (Finish ID:59B)	Split Satin Copper and Oil Rubbed Bronze with Satin Copper Back Plate (Finish ID:60A)	Split Satin Copper and Oil Rubbed Bronze with Oil Rubbed Bronze Back Plate (Finish ID:60B)	Graphite (Finish ID:61)	Split Aged Brass and English Metallic Bronze with Aged Brass Back Plate (Finish ID:75A)	Split Aged Brass and English Metallic Bronze with English Metallic Bronze Back Plate (Finish ID:75B)	Split Polished Nickel and Satin Brass with Satin Brass Back Plate (Finish ID:77A)
						
Split Polished Nickel and Satin Brass with Polished Nickel Back Plate (Finish ID:77B)	Split Brush Nickel and Satin Brass with Satin Brass Back Plate (Finish ID:78A)	Split Brush Nickel and Satin Brass with Brush Nickel Back Plate (Finish ID:78B)	Titanium (Finish ID:79)	Split Oil Rubbed Bronze And Satin Brass with Satin Brass Back Plate (Finish ID:80A)	Split Oil Rubbed Bronze And Satin Brass with Oil Rubbed Bronze Back Plate (Finish ID:80B)	Split Graphite and Satin Brass with Satin Brass Back Plate (Finish ID:90A)
						
Split Graphite and Satin Brass with Graphite Back Plate (Finish ID:90B)	Split Graphite and Brush Chrome with Graphite Back Plate (Finish ID:91A)	Split Graphite and Brush Chrome with Brush Chrome Back Plate (Finish ID:91B)	Ombre (Finish ID:92)	Brush Chrome (Finish ID:95)		

- Custom finishes cannot be returned or refunded. We are unable to accept cancellations for custom finish order unless within 48 hours of the order being placed.
- We have uniform pricing for all non-hammered finishes listed above as long as base material and size is same.
- Contact us for customized finishes, refer pages F1, F2, F3 & F4 for finish glossary.
- Backplate options refer page KBP1-1 to KBP14-1.

Harlequin Knob With Back Plate Split Finish

KNB.918.XX.XX

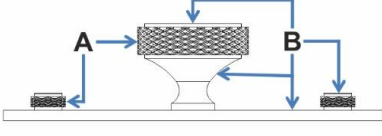
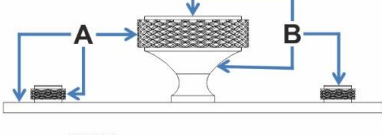
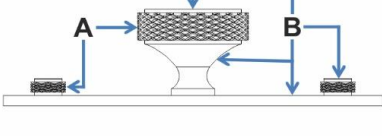
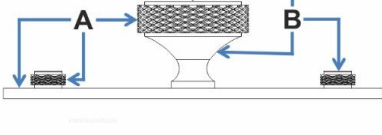
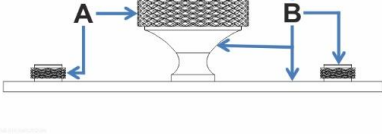
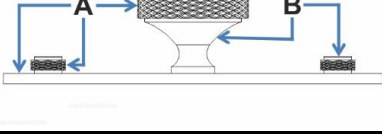
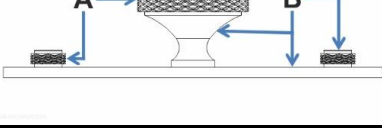
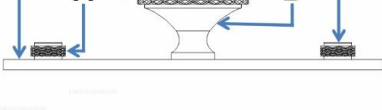
FINISH CODE (XX)	FINISH NAME	LINE DRAWING	A	B
KNB.918.XX.48A	Split Black and Nickel with Polished Nickel Back Plate		Matte Black	Polished Nickel
KNB.918.XX.48B	Split Black and Nickel with Black Back Plate		Matte Black	Polished Nickel
KNB.918.XX.49A	Split Black and Satin Brass with Satin Brass Back Plate		Matte Black	Satin Brass
KNB.918.XX.49B	Split Black and Satin Brass with Black Back Plate		Matte Black	Satin Brass
KNB.918.XX.50A	Split Satin Brass and White with Satin Brass Back Plate		White Epoxy	Satin Brass
KNB.918.XX.50B	Split Satin Brass and White with White Back Plate		White Epoxy	Satin Brass
KNB.918.XX.57A	Split Lacquered Polished Brass and Oil Rubbed Bronze with Lacquered Polished Brass Back Plate		Oil Rubbed Bronze	Lacquered Polished Brass
KNB.918.XX.57B	Split Lacquered Polished Brass and Oil Rubbed Bronze with Oil Rubbed Bronze Back Plate		Oil Rubbed Bronze	Lacquered Polished Brass

Harlequin Knob With Back Plate Split Finish

KNB.918.XX.XX

FINISH CODE (XX)	FINISH NAME	LINE DRAWING	A	B
KNB.918.XX.59A	Split Black and chrome with chrome back plate		Matte Black	Bright Chrome
KNB.918.XX.59B	Split Black and chrome / Black back plate		Matte Black	Bright Chrome
KNB.918.XX.60A	Split Satin Copper and Oil Rubbed Bronze with Satin Copper Back Plate		Oil Rubbed Bronze	Satin Copper
KNB.918.XX.60B	Split Satin Copper and Oil Rubbed Bronze with Oil Rubbed Bronze Back Plate		Oil Rubbed Bronze	Satin Copper
KNB.918.XX.75A	Split Aged Brass and English Metallic Bronze with Aged Brass Back Plate		English Metallic Bronze	Aged Brass
KNB.918.XX.75B	Split Aged Brass and English Metallic Bronze with English Metallic Bronze Back Plate		English Metallic Bronze	Aged Brass
KNB.918.XX.77A	Split Polished Nickel and Satin Brass with Satin Brass Back Plate		Polished Nickel	Satin Brass
KNB.918.XX.77B	Split Polished Nickel and Satin Brass with Polished Nickel Back Plate		Polished Nickel	Satin Brass

Harlequin Knob With Back Plate Split Finish

KNB.918.XX.XX

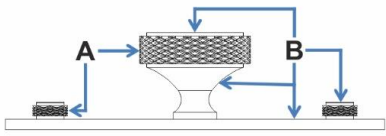
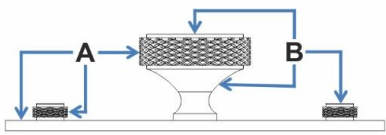
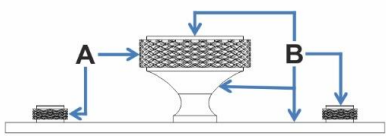
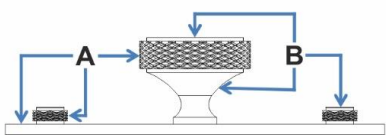
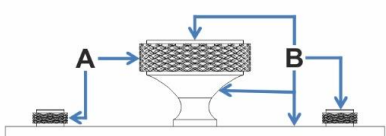
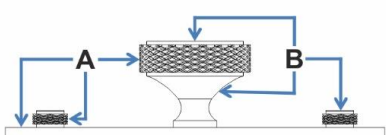
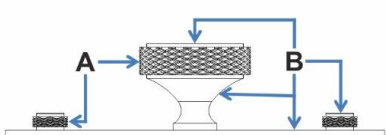
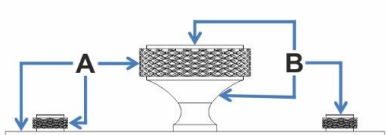
FINISH CODE (XX)	FINISH NAME	LINE DRAWING	A	B
KNB.918.XX.78A	Split Brush Nickel and Satin Brass with Satin Brass Back Plate		Brush Nickel	Satin Brass
KNB.918.XX.78B	Split Brush Nickel and Satin Brass with Brush Nickel Back Plate		Brush Nickel	Satin Brass
KNB.918.XX.80A	Split Oil Rubbed Bronze and Satin Brass with Satin Brass Back Plate		Oil Rubbed Bronze	Satin Brass
KNB.918.XX.80B	Split Oil Rubbed Bronze and Satin Brass with Oil Rubbed Bronze Back Plate		Oil Rubbed Bronze	Satin Brass
KNB.918.XX.90A	Split Graphite and Satin Brass with Satin Brass Back Plate		Graphite	Satin Brass
KNB.918.XX.90B	Split Graphite and Satin Brass with Graphite Back Plate		Graphite	Satin Brass
KNB.918.XX.91A	Split Graphite and Brush Chrome with Brush Chrome Back Plate		Graphite	Brush Chrome
KNB.918.XX.91B	Split Graphite and Brush Chrome with Graphite Back Plate		Graphite	Brush Chrome

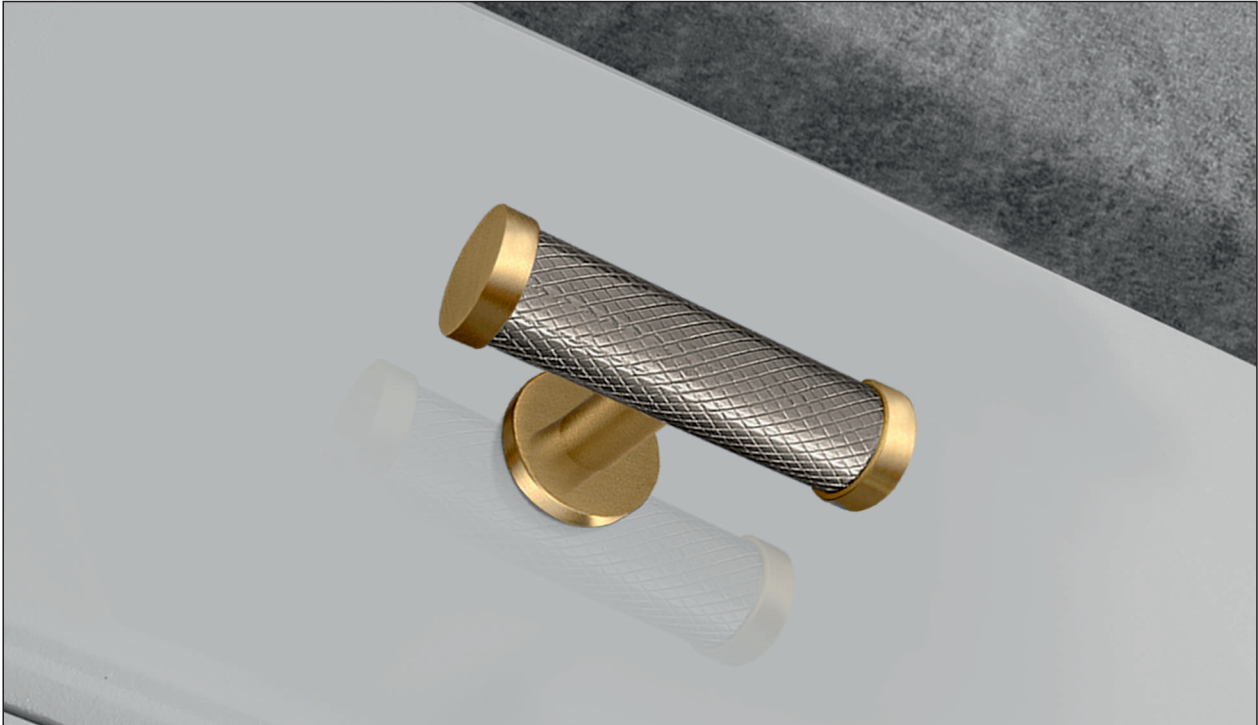

Split Polished Nickel And Satin Brass (Finish ID : 77)

KOLOKOLO T KNOB

	Item Code	Size (mm & Inches)	Material	Size (Inches)				Fig.
				A	B	C	D	
1	TKNB.921.55.XX	55mm (2.17")	Brass	1.57	2.56	0.71	N/A	1
2	TKNB.921.90.XX	90mm (3.54")	Brass	1.57	3.94	0.71	N/A	1

"XX" in item code denotes Finish ID.

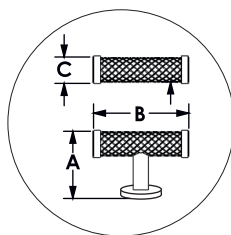

FIG. 1





























This product is Supplied with M4x25mm screws.
This product is Supplied with M4x45mm break off screws.

How to Order

TKNB.921.55.77

T KNOB STYLE : KOLOKOLO SIZE DIAMETER : 55 MM FINISH ID : 77

KoloKolo T Knob Finish Options

Base Material : Brass		Standard Finishes (2-3 Weeks Delivery)				
						
Bright Chrome (Finish ID:2)	Brush Nickel (Finish ID:3)	Aged Brass (Finish ID:4)	Oil Rubbed Bronze (Finish ID:5)	Unlacquered Polished Brass (Finish ID:7U)	Polished Nickel (Finish ID:8)	Satin Brass (Finish ID:13)
Base Material : Brass		Custom Finishes (3-4 Weeks Delivery)*				
						
Lacquered Polished Brass (Finish ID:7L)	Antique Copper (Finish ID:15)	Matte Black (Finish ID:19)	Split White and Nickel (Finish ID:20)	Split Black and Polished Nickel (Finish ID:48)	Split Black and Satin Brass (Finish ID:49)	Split Satin Brass and White (Finish ID:50)
						
English Metallic Bronze (Finish ID:51)	Split Polished Brass And Oil Rubbed Bronze (Finish ID:57)	Satin Copper (Finish ID:58)	Split Black And Chrome (Finish ID:59)	Split Satin Copper And Oil Rubbed Bronze (Finish ID:60)	Graphite (Finish ID:61)	Split Aged Brass And English Metallic Bronze (Finish ID:75)
						
Split Polished Nickel And Satin Brass (Finish ID:77)	Split Brush Nickel and Satin Brass (Finish ID:78)	Titanium (Finish ID:79)	Split Oil Rubbed Bronze and Satin Brass (Finish ID:80)	Split Graphite and Satin Brass (Finish ID:90)	Split Graphite and Brush Chrome (Finish ID:91)	Ombre (Finish ID:92)
						
Brush Chrome (Finish ID:95)						

- Custom finishes cannot be returned or refunded. We are unable to accept cancellations for custom finish order unless within 48 hours of the order being placed.
- We have uniform pricing for all non-hammered finishes listed above as long as base material and size is same.
- Contact us for customized finishes, refer pages F1, F2, F3 & F4 for finish glossary.
- Backplate options refer page KBP1-1 to KBP14-1.

Kolo Kolo T knob Split Finish

TKNB.921.XX.XX

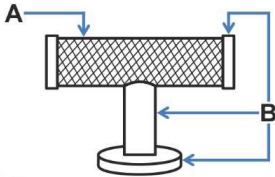
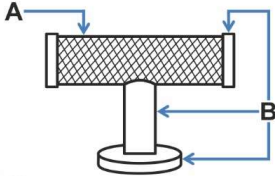
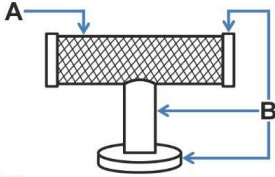
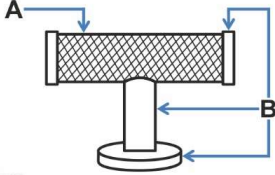
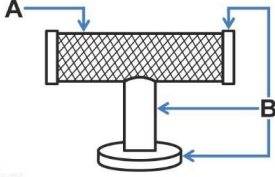
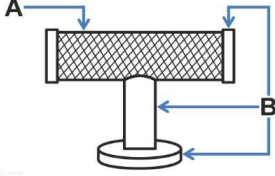
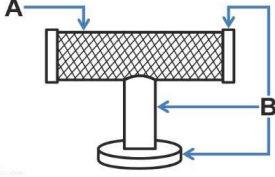
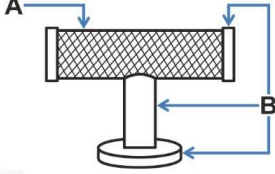
FINISH CODE (XX)	FINISH NAME	LINE DRAWING	A	B
TKNB.921.XX.48	Split Black and Polished Nickel		Matte Black	Polished Nickel
TKNB.921.XX.49	Split Black and Satin Brass		Matte Black	Satin Brass
TKNB.921.XX.50	Split Satin Brass and White		White Epoxy	Satin Brass
TKNB.921.XX.57	Split Polished Brass and Oil Rubbed Bronze		Oil Rubbed Bronze	Lacquered Polished Brass
TKNB.921.XX.59	Split Black and Chrome		Matte Black	Bright Chrome
TKNB.921.XX.60	Split Satin Copper and Oil Rubbed Bronze		Oil Rubbed Bronze	Satin Copper
TKNB.921.XX.75	Split Aged Brass and English Metallic Bronze		English Metallic Bronze	Aged Brass
TKNB.921.XX.77	Split Polished Nickel and Satin Brass		Satin Brass	Polished Nickel

Kolo Kolo T knob Split Finish

TKNB.921.XX.XX

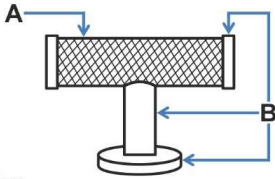
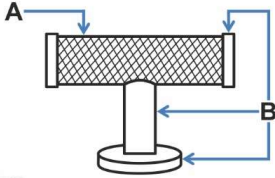
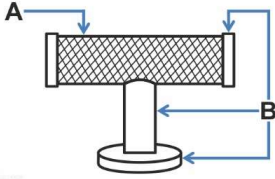
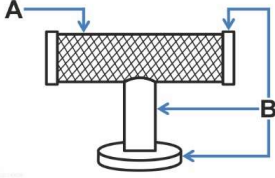
FINISH CODE (XX)	FINISH NAME	LINE DRAWING	A	B
TKNB.921.XX.78	Split Brush Nickel and Satin Brass		Brush Nickel	Satin Brass
TKNB.921.XX.80	Split Oil Rubbed Bronze and Satin Brass		Oil Rubbed Bronze	Satin Brass
TKNB.921.XX.90	Split Graphite and Satin Brass		Graphite	Satin Brass
TKNB.921.XX.91	Split Graphite and Brush Chrome		Graphite	Brush Chrome

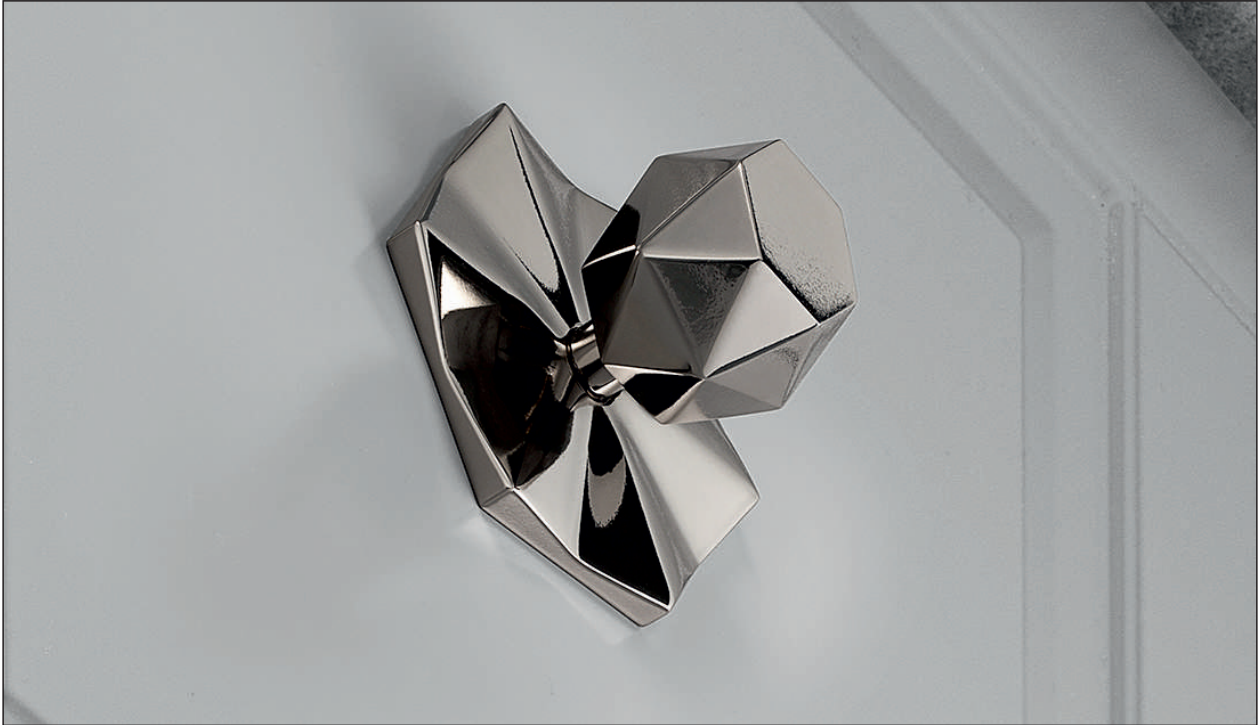

Polished Nickel (Finish ID : 8)

ALBEMARLE KNOB FACETED BACK PLATE

“The hexagonal shape of the knob allied to the precise faceted back plate give the suggestion of a rose opening in the summer sun. Polished nickel reflects light like a prism while aged brass absorbs light accentuating the faceted detail.”

	Item Code	Size (mm & Inches)	Material	Size (Inches)				Fig.
				A	B	C	D	
1	KNB.922.32.XX	32mm (1.26")	Brass	1.73	1.26	2.5	N/A	1
2	KNB.922.38.XX	38mm (1.5")	Brass	1.89	1.5	2.99	N/A	1

"XX" in item code denotes Finish ID.

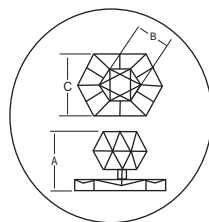

FIG. 1





























This product is Supplied with M4x30mm screws.
This product is Supplied with M4x45mm break off screws.

How to Order

KNB.922.32.8

KNOB STYLE : ALBEMARLE FACETED BACK PLATE SIZE DIAMETER : 32 MM FINISH ID : 8

Albemarle Knob Faceted Back Plate Finish Options

Base Material : Brass				Standard Finishes (2-3 Weeks Delivery)		
						
Bright Chrome (Finish ID:2)	Brush Nickel (Finish ID:3)	Aged Brass (Finish ID:4)	Oil Rubbed Bronze (Finish ID:5)	Unlacquered Polished Brass (Finish ID:7U)	Polished Nickel (Finish ID:8)	Satin Brass (Finish ID:13)
Base Material : Brass				Custom Finishes (3-4 Weeks Delivery)*		
						
Lacquered Polished Brass (Finish ID:7L)	Antique Copper (Finish ID:15)	Matte Black (Finish ID:19)	Rose Gold (Finish ID:33)	Split Black and Polished Nickel with Polished Nickel Back Plate (Finish ID:48A)	Split Black and Polished Nickel with Black Back Plate (Finish ID:48B)	Split Black and Satin Brass with Satin Brass Back Plate (Finish ID:49A)
						
Split Black and Satin Brass with Black Back Plate (Finish ID:49B)	Split Satin Brass and White with Satin Brass Back Plate (Finish ID:50A)	Split Satin Brass and White with White Back Plate (Finish ID:50B)	English Metallic Bronze (Finish ID:51)	Split Polished Brass and Oil Rubbed Bronze with Polished Brass Back Plate (Finish ID:57A)	Split Polished Brass and Oil Rubbed Bronze with Oil Rubbed Bronze Back Plate (Finish ID:57B)	Split Black and Chrome with Chrome Back Plate (Finish ID:59A)
						
Split Black and Chrome with Black Back Plate (Finish ID:59B)	Split Satin Copper and Oil Rubbed Bronze with Satin Copper Back Plate (Finish ID:60A)	Split Satin Copper and Oil Rubbed Bronze with Oil Rubbed Bronze Back Plate (Finish ID:60B)	Graphite (Finish ID:61)	Split Aged Brass and English Metallic Bronze with Aged Brass Back Plate (Finish ID:75A)	Split Aged Brass and English Metallic Bronze with English Metallic Bronze Back Plate (Finish ID:75B)	Split Polished Nickel and Satin Brass with Satin Brass Back Plate (Finish ID:77A)

- Custom finishes cannot be returned or refunded. We are unable to accept cancellations for custom finish order unless within 48 hours of the order being placed.
- We have uniform pricing for all non-hammered finishes listed above as long as base material and size is same.
- Contact us for customized finishes, refer pages F1, F2, F3 & F4 for finish glossary.
- Backplate options refer page KBP1-1 to KBP14-1.

Base Material : Brass		Custom Finishes (3-4 Weeks Delivery)*				
 Split Polished Nickel and Satin Brass with Polished Nickel Back Plate (Finish ID:77B)	 Split Brush Nickel and Satin Brass with Satin Brass Back Plate (Finish ID:78A)	 Split Brush Nickel and Satin Brass with Brush Nickel Back Plate (Finish ID:78B)	 Titanium (Finish ID:79)	 Split Oil Rubbed Bronze And Satin Brass with Satin Brass Back Plate (Finish ID:80A)	 Split Oil Rubbed Bronze And Satin Brass with Oil Rubbed Bronze Back Plate (Finish ID:80B)	 Split Graphite and Satin Brass with Satin Brass Back Plate (Finish ID:90A)
 Split Graphite and Satin Brass with Graphite Back Plate (Finish ID:90B)	 Split Graphite and Brush Chrome with Graphite Back Plate (Finish ID:91A)	 Split Graphite and Brush Chrome with Brush Chrome Back Plate (Finish ID:91B)	 Ombre (Finish ID:92)	 Brush Chrome (Finish ID:95)		

- Custom finishes cannot be returned or refunded. We are unable to accept cancellations for custom finish order unless within 48 hours of the order being placed.
- We have uniform pricing for all non-hammered finishes listed above as long as base material and size is same.
- Contact us for customized finishes, refer pages F1, F2, F3 & F4 for finish glossary.
- Backplate options refer page KBP1-1 to KBP14-1.

Albemarle Knob With Faced Back Plate Split Finish

KNB.922.XX.XX

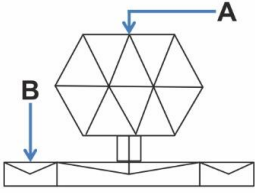
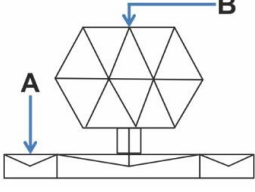
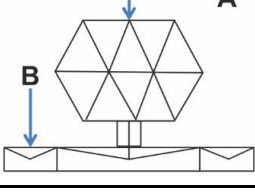
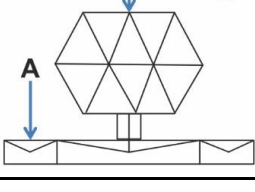
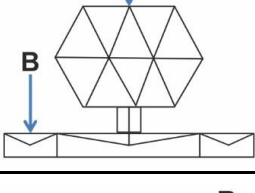
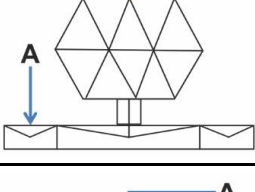
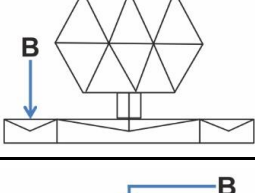
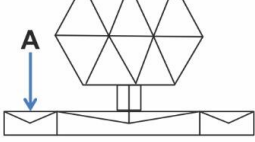
FINISH CODE (XX)	FINISH NAME	LINE DRAWING	A	B
KNB.922.XX.48A	Split Black and Nickel with Polished Nickel Back Plate		Matte Black	Polished Nickel
KNB.922.XX.48B	Split Black and Nickel with Black Back Plate		Matte Black	Polished Nickel
KNB.922.XX.49A	Split Black and Satin Brass with Satin Brass Back Plate		Matte Black	Satin Brass
KNB.922.XX.49B	Split Black and Satin Brass with Black Back Plate		Matte Black	Satin Brass
KNB.922.XX.50A	Split Satin Brass and White with Satin Brass Back Plate		White Epoxy	Satin Brass
KNB.922.XX.50B	Split Satin Brass and White with White Back Plate		White Epoxy	Satin Brass
KNB.922.XX.57A	Split Lacquered Polished Brass and Oil Rubbed Bronze with Lacquered Polished Brass Back Plate		Oil Rubbed Bronze	Lacquered Polished Brass
KNB.922.XX.57B	Split Lacquered Polished Brass and Oil Rubbed Bronze with Oil Rubbed Bronze Back Plate		Oil Rubbed Bronze	Lacquered Polished Brass

Albemarle Knob With Faced Back Plate Split Finish

KNB.922.XX.XX

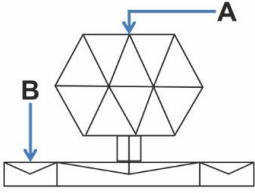
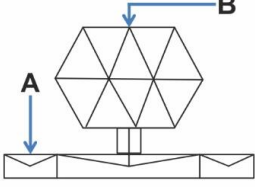
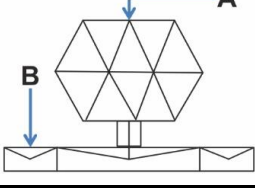
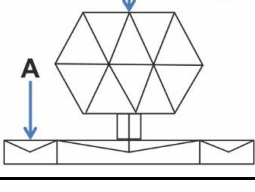
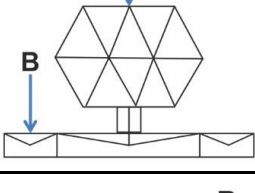
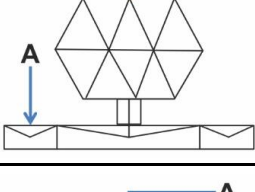
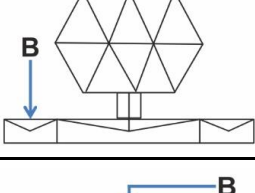
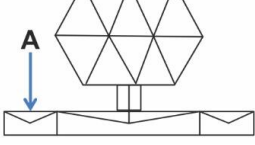
FINISH CODE (XX)	FINISH NAME	LINE DRAWING	A	B
KNB.922.XX.59A	Split Black and chrome with chrome back plate		Matte Black	Bright Chrome
KNB.922.XX.59B	Split Black and chrome / Black back plate		Matte Black	Bright Chrome
KNB.922.XX.60A	Split Satin Copper and Oil Rubbed Bronze with Satin Copper Back Plate		Oil Rubbed Bronze	Satin Copper
KNB.922.XX.60B	Split Satin Copper and Oil Rubbed Bronze with Oil Rubbed Bronze Back Plate		Oil Rubbed Bronze	Satin Copper
KNB.922.XX.75A	Split Aged Brass and English Metallic Bronze with Aged Brass Back Plate		English Metallic Bronze	Aged Brass
KNB.922.XX.75B	Split Aged Brass and English Metallic Bronze with English Metallic Bronze Back Plate		English Metallic Bronze	Aged Brass
KNB.922.XX.77A	Split Polished Nickel and Satin Brass with Satin Brass Back Plate		Polished Nickel	Satin Brass
KNB.922.XX.77B	Split Polished Nickel and Satin Brass with Polished Nickel Back Plate		Polished Nickel	Satin Brass

Albemarle Knob With Faced Back Plate Split Finish

KNB.922.XX.XX

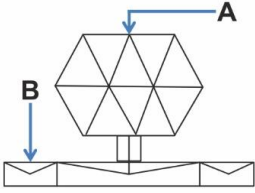
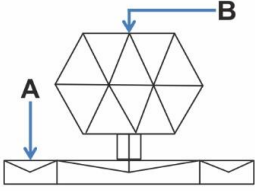
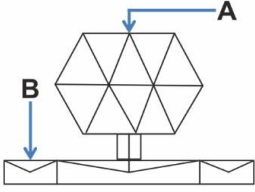
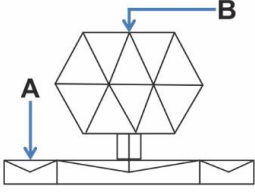
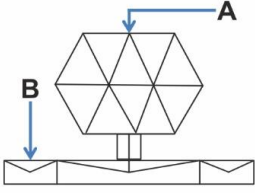
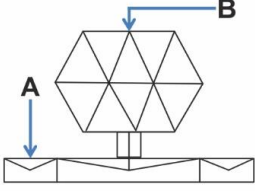
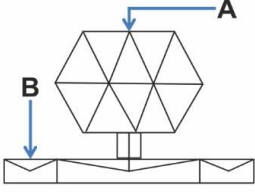
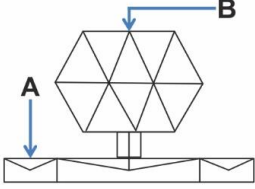
FINISH CODE (XX)	FINISH NAME	LINE DRAWING	A	B
KNB.922.XX.78A	Split Brush Nickel and Satin Brass with Satin Brass Back Plate		Brush Nickel	Satin Brass
KNB.922.XX.78B	Split Brush Nickel and Satin Brass with Brush Nickel Back Plate		Brush Nickel	Satin Brass
KNB.922.XX.80A	Split Oil Rubbed Bronze and Satin Brass with Satin Brass Back Plate		Oil Rubbed Bronze	Satin Brass
KNB.922.XX.80B	Split Oil Rubbed Bronze and Satin Brass with Oil Rubbed Bronze Back Plate		Oil Rubbed Bronze	Satin Brass
KNB.922.XX.90A	Split Graphite and Satin Brass with Satin Brass Back Plate		Graphite	Satin Brass
KNB.922.XX.90B	Split Graphite and Satin Brass with Graphite Back Plate		Graphite	Satin Brass
KNB.922.XX.91A	Split Graphite and Brush Chrome with Brush Chrome Back Plate		Graphite	Brush Chrome
KNB.922.XX.91B	Split Graphite and Brush Chrome with Graphite Back Plate		Graphite	Brush Chrome



Satin Brass (Finish ID : 13)

ANNE KNOB WITH BACK PLATE

“Anne exemplifies the Art Moderne & Art Streamline movement, design in its simplest form devoid of any excess. Available with or without a back plate.”

	Item Code	Size (mm & Inches)	Material	Size (Inches)				Fig.
				A	B	C	D	
1	KNB.923.25.XX	25mm (0.98")	Brass	0.98	0.98	3.15	0.79	1
2	KNB.923.32.XX	32mm (1.26")	Brass	1.19	1.25	4	1	1

“XX” in item code denotes Finish ID.

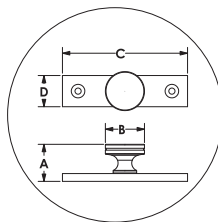

FIG. 1

This product is Supplied with M4x30mm screws.
This product is Supplied with M10x19mm Flat Head Wood screws.

How to Order

KNB.923.25.13

KNOB STYLE : ANNE WITH BACK PLATE SIZE DIAMETER : 25 MM FINISH ID : 13

Anne Knob With Back Plate Finish Options

Base Material : Brass		Standard Finishes (2-3 Weeks Delivery)				
						
Bright Chrome (Finish ID:2)	Brush Nickel (Finish ID:3)	Aged Brass (Finish ID:4)	Oil Rubbed Bronze (Finish ID:5)	Unlacquered Polished Brass (Finish ID:7U)	Polished Nickel (Finish ID:8)	Satin Brass (Finish ID:13)
Base Material : Brass		Custom Finishes (3-4 Weeks Delivery)*				
						
Lacquered Polished Brass (Finish ID:7L)	English Metallic Bronze (Finish ID:51)	Ombre (Finish ID:92)	Brush Chrome (Finish ID:95)			

- Custom finishes cannot be returned or refunded. We are unable to accept cancellations for custom finish order unless within 48 hours of the order being placed.
- We have uniform pricing for all non-hammered finishes listed above as long as base material and size is same.
- Contact us for customized finishes, refer pages F1, F2, F3 & F4 for finish glossary.
- Backplate options refer page KBP1-1 to KBP14-1.



Graphite (Finish ID:61)

ELLIS T KNOB

1	Item Code	Size (mm & Inches)	Material	Size (Inches)				Fig.
				A	B	C	D	
	TKNB.1002.55.XX	55mm (2.165")	Brass	1.54	2.17	0.5	N/A	1

"XX" in item code denotes Finish ID.

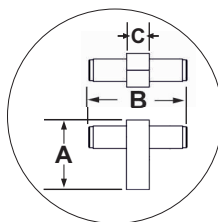

FIG. 1



























This product is Supplied with M4x25mm screws.
This product is Supplied with M4x45mm break off screws.

How to Order

TKNB.1002.55.61

T KNOB STYLE : ELLIS SIZE DIAMETER : 55 MM FINISH ID : 61

Ellis T Knob Finish Options

Base Material : Brass		Standard Finishes (2-3 Weeks Delivery)				
						
Bright Chrome (Finish ID:2)	Brush Nickel (Finish ID:3)	Aged Brass (Finish ID:4)	Oil Rubbed Bronze (Finish ID:5)	Unlacquered Polished Brass (Finish ID:7U)	Polished Nickel (Finish ID:8)	Satin Brass (Finish ID:13)
Base Material : Brass		Custom Finishes (3-4 Weeks Delivery)*				
						
Lacquered Polished Brass (Finish ID:7L)	Antique Copper (Finish ID:15)	Matte Black (Finish ID:19)	Split Black and Polished Nickel (Finish ID:48)	Split Black and Satin Brass (Finish ID:49)	Split Satin Brass and White (Finish ID:50)	English Metallic Bronze (Finish ID:51)
						
Split Polished Brass And Oil Rubbed Bronze (Finish ID:57)	Split Black And Chrome (Finish ID:59)	Split Satin Copper And Oil Rubbed Bronze (Finish ID:60)	Graphite (Finish ID:61)	Split Aged Brass And English Metallic Bronze (Finish ID:75)	Split Polished Nickel And Satin Brass (Finish ID:77)	Split Brush Nickel and Satin Brass (Finish ID:78)
						
Split Oil Rubbed Bronze and Satin Brass (Finish ID:80)	Split Graphite and Satin Brass (Finish ID:90)	Split Graphite and Brush Chrome (Finish ID:91)	Titanium (Finish ID:79)	Ombre (Finish ID:92)	Brush Chrome (Finish ID:95)	

- Custom finishes cannot be returned or refunded. We are unable to accept cancellations for custom finish order unless within 48 hours of the order being placed.
- We have uniform pricing for all non-hammered finishes listed above as long as base material and size is same.
- Contact us for customized finishes, refer pages F1, F2, F3 & F4 for finish glossary.
- Backplate options refer page KBP1-1 to KBP14-1.

Ellis T knob Split Finish

TKNB.1002.XX.XX

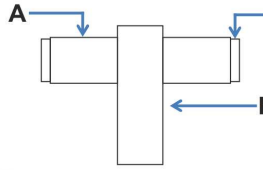
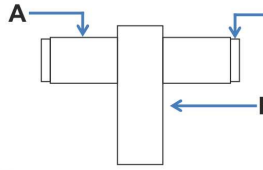
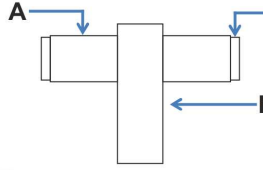
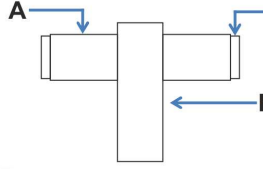
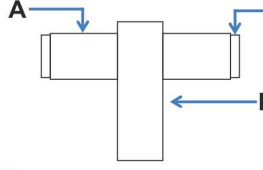
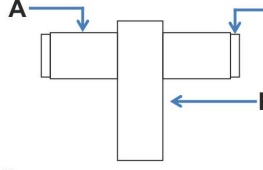
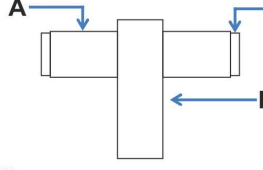
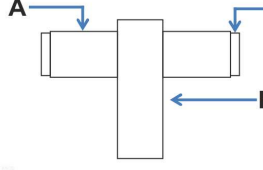
FINISH CODE (XX)	FINISH NAME	LINE DRAWING	A	B
TKNB.1002.XX.48	Split Black and Polished Nickel		Matte Black	Polished Nickel
TKNB.1002.XX.49	Split Black and Satin Brass		Matte Black	Satin Brass
TKNB.1002.XX.50	Split Satin Brass and White		White Epoxy	Satin Brass
TKNB.1002.XX.57	Split Polished Brass and Oil Rubbed Bronze		Oil Rubbed Bronze	Lacquered Polished Brass
TKNB.1002.XX.59	Split Black and Chrome		Matte Black	Bright Chrome
TKNB.1002.XX.60	Split Satin Copper and Oil Rubbed Bronze		Oil Rubbed Bronze	Satin Copper
TKNB.1002.XX.75	Split Aged Brass and English Metallic Bronze		English Metallic Bronze	Aged Brass
TKNB.1002.XX.77	Split Polished Nickel and Satin Brass		Satin Brass	Polished Nickel

Ellis T knob Split Finish

TKNB.1002.XX.XX

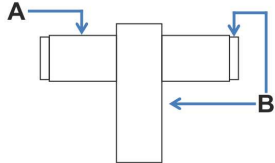
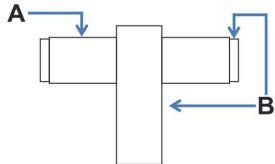
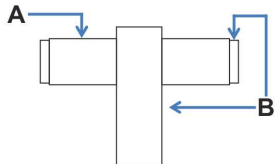
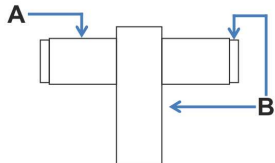
FINISH CODE (XX)	FINISH NAME	LINE DRAWING	A	B
TKNB.1002.XX.78	Split Brush Nickel and Satin Brass		Brush Nickel	Satin Brass
TKNB.1002.XX.80	Split Oil Rubbed Bronze and Satin Brass		Oil Rubbed Bronze	Satin Brass
TKNB.1002.XX.90	Split Graphite and Satin Brass		Graphite	Satin Brass
TKNB.1002.XX.91	Split Graphite and Brush Chrome		Graphite	Brush Chrome



Polished Nickel/Tan (Finish ID:66)

MANCHESTER T KNOB

Item Code	Size (mm & Inches)	Material	Size (Inches)				Fig.
			A	B	C	D	
1 TKNB.1004.55.XX	55mm (2.17")	Brass/Leather	1.2	2.17	1	0.71	1

"XX" in item code denotes Finish ID.

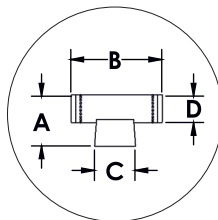

FIG. 1

This product is Supplied with M4x25mm screws.
This product is Supplied with M4x45mm break off screws.

How to Order

TKNB.1004.55.66

T KNOB STYLE : MANCHESTER SIZE DIAMETER : 55 MM FINISH ID : 66

Manchester T Knob Finish Options

Base Material : Brass/Leather		Custom Finishes (3-4 Weeks Delivery)*				
						
Split Unlacquered Polished Brass and Tan Leather (Finish ID:62)	Split Aged Brass and Tan Leather (Finish ID:63)	Split Satin Brass and Tan Leather (Finish ID:64)	Split Oil Rubbed Bronze and Burgundy Leather (Finish ID:65)	Split Polished Nickel and Tan Leather (Finish ID:66)	Split Bright Chrome and Black Leather (Finish ID:67)	Split Polished Nickel and Pewter Leather (Finish ID:68)
						
Split Unlacquered Polished Brass and Pewter Leather (Finish ID:69)	Split Brush Nickel and Tan Leather (Finish ID:70)	Split Grey Leather And Black (Finish ID:88)	Split White Distress Leather And Black (Finish ID:89)	Split Polished Nickel And Light Grey Leather (Finish ID:94)		

- Custom finishes cannot be returned or refunded. We are unable to accept cancellations for custom finish order unless within 48 hours of the order being placed.
- We have uniform pricing for all non-hammered finishes listed above as long as base material and size is same.
- Contact us for customized finishes, refer pages F1, F2, F3 & F4 for finish glossary.
- Backplate options refer page KBP1-1 to KBP14-1.

Manchester T Knob Split Finish

TKNB.1004.XX.XX

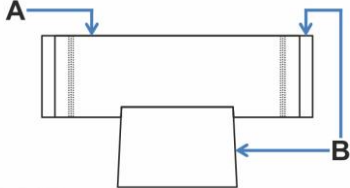
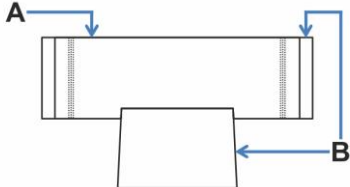
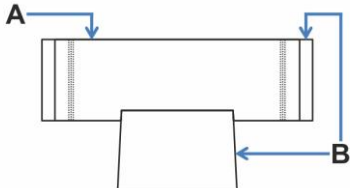
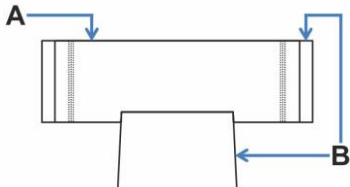
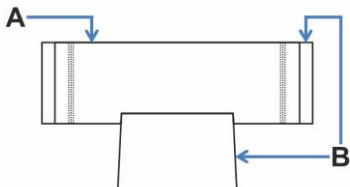
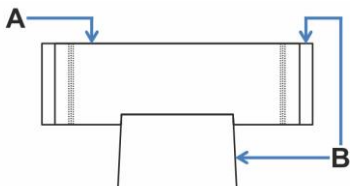
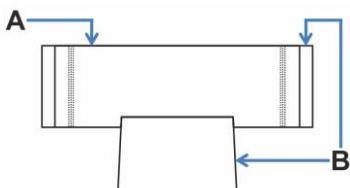
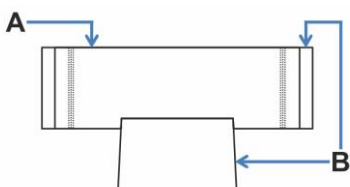
FINISH CODE (XX)	FINISH NAME	LINE DRAWING	A	B
TKNB.1004.XX.62	Split Unlacquered Polished Brass and Tan Leather		Tan Leather	Unlacquered Polished Brass
TKNB.1004.XX.63	Split Aged Brass and Tan Leather		Tan Leather	Aged Brass
TKNB.1004.XX.64	Split Satin Brass and Tan Leather		Tan Leather	Satin Brass
TKNB.1004.XX.65	Split Oil Rubbed Bronze and Burgundy Leather		Burgundy Leather	Oil Rubbed Bronze
TKNB.1004.XX.66	Split Polished Nickel and Tan Leather		Tan Leather	Polished Nickel
TKNB.1004.XX.67	Split Bright Chrome and Black Leather		Black Leather	Bright Chrome
TKNB.1004.XX.68	Split Polished Nickel and Pewter Leather		Pewter Leather	Polished Nickel
KNB.613.XX.69	Split Unlacquered Polished Brass and Pewter Leather		Pewter Leather	Unlacquered Polished Brass

Manchester T Knob Split Finish

TKNB.1004.XX.XX

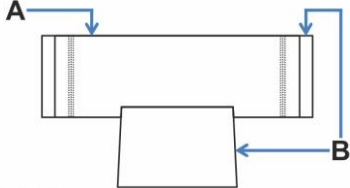
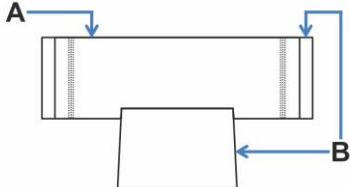
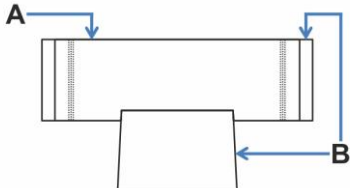
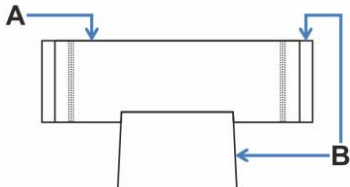
FINISH CODE (XX)	FINISH NAME	LINE DRAWING	A	B
TKNB.1004.XX.70	Split Brush Nickel and Tan Leather		Tan Leather	Brush Nickel
TKNB.1004.XX.88	Split Black and Dark Grey Leather		Grey Leather	Matte Black
TKNB.1004.XX.89	Split Black and White Distress Leather		Distress Leather	Matte Black
TKNB.1004.XX.94	Split Polished Nickel and Light Grey Leather		Grey Leather	Polished Nickel

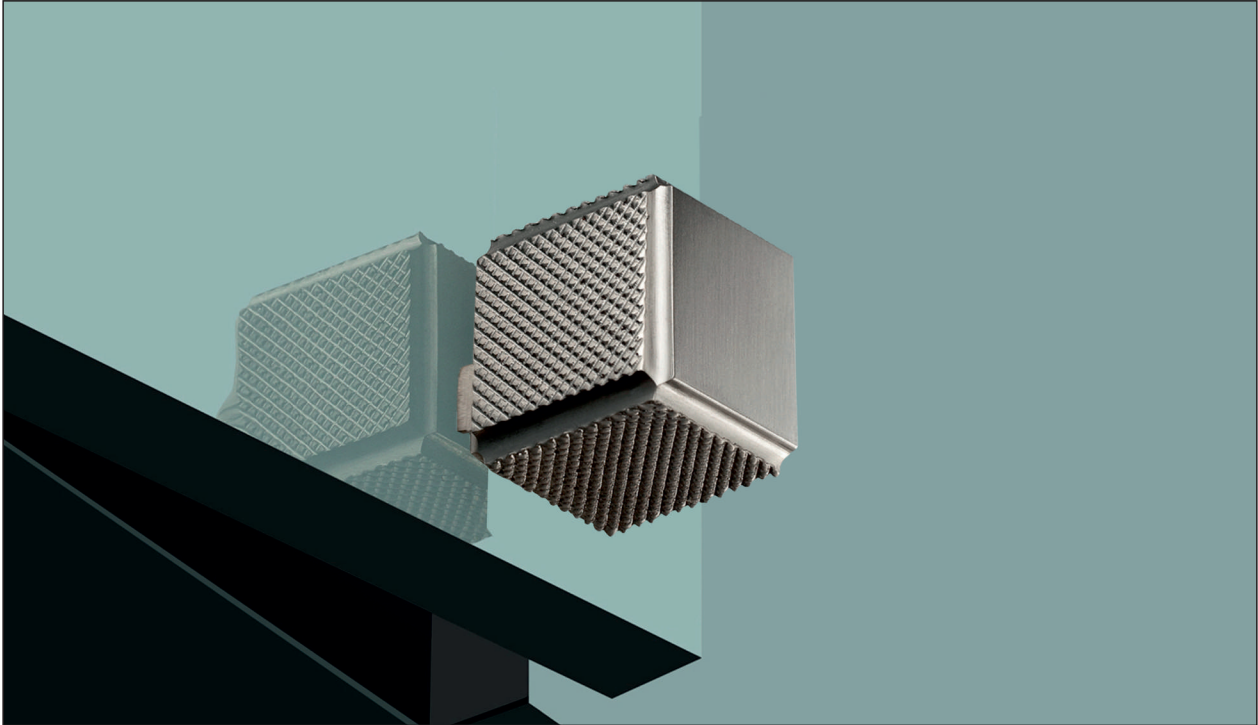

Brush Nickel (Finish ID : 3)

ODEL KNOB WITHOUT BACKPLATE

	Item Code	Size (mm & Inches)	Material	Size (Inches)				Fig.
				A	B	C	D	
1	KNB.1014.25.XX	25mm (0.98")	Brass	1.28	0.98	0.91	N/A	1
2	KNB.1014.32.XX	32mm (1.26")	Brass	1.56	1.22	1.1	N/A	1

"XX" in item code denotes Finish ID.

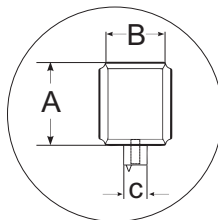

FIG. 1



























This product is Supplied with M4x25mm screws.
This product is Supplied with M4x45mm break off screws.

How to Order

KNB.1014.25.3

KNOB STYLE : ODEL KNOB WITHOUT BACK PLATE SIZE DIAMETER : 25 MM FINISH ID : 3

Odel Knob Without Back Plate Finish Options

Base Material : Brass			Standard Finishes (2-3 Weeks Delivery)			
						
Bright Chrome (Finish ID:2)	Brush Nickel (Finish ID:3)	Aged Brass (Finish ID:4)	Oil Rubbed Bronze (Finish ID:5)	Unlacquered Polished Brass (Finish ID:7U)	Polished Nickel (Finish ID:8)	Satin Brass (Finish ID:13)
Base Material : Brass			Custom Finishes (3-4 Weeks Delivery)*			
						
Lacquered Polished Brass (Finish ID:7L)	Antique Copper (Finish ID:15)	Matte Black (Finish ID:19)	Split Black and Polished Nickel (Finish ID:48)	Split Black and Satin Brass (Finish ID:49)	Split Satin Brass and White (Finish ID:50)	English Metallic Bronze (Finish ID:51)
						
Split Polished Brass And Oil Rubbed Bronze (Finish ID:57)	Split Black And Chrome (Finish ID:59)	Split Satin Copper And Oil Rubbed Bronze (Finish ID:60)	Graphite (Finish ID:61)	Split Aged Brass And English Metallic Bronze (Finish ID:75)	Split Polished Nickel And Satin Brass (Finish ID:77)	Split Brush Nickel and Satin Brass (Finish ID:78)
						
Titanium (Finish ID:79)	Split Oil Rubbed Bronze and Satin Brass (Finish ID:80)	Split Graphite and Satin Brass (Finish ID:90)	Split Graphite and Brush Chrome (Finish ID:91)	Ombre (Finish ID:92)	Brush Chrome (Finish ID:95)	

- Custom finishes cannot be returned or refunded. We are unable to accept cancellations for custom finish order unless within 48 hours of the order being placed.
- We have uniform pricing for all non-hammered finishes listed above as long as base material and size is same.
- Contact us for customized finishes, refer pages F1, F2, F3 & F4 for finish glossary.
- Backplate options refer page KBP1-1 to KBP14-1.

Odel Knob Without Back Plate Split Finish

KNB.1014.XX.XX

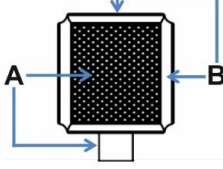
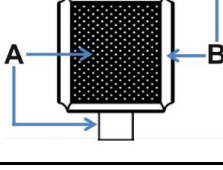
FINISH CODE (XX)	FINISH NAME	LINE DRAWING	A	B
KNB.1014.XX.48	Split Black and Polished Nickel		Matte Black	Polished Nickel
KNB.1014.XX.49	Split Black and Satin Brass		Matte Black	Satin Brass
KNB.1014.XX.50	Split Satin Brass and White		White Epoxy	Satin Brass
KNB.1014.XX.57	Split Polished Brass and Oil Rubbed Bronze		Oil Rubbed Bronze	Lacquered Polished Brass
KNB.1014.XX.59	Split Black and Chrome		Matte Black	Bright Chrome
TKNB.1014.XX.60	Split Satin Copper and Oil Rubbed Bronze		Oil Rubbed Bronze	Satin Copper
KNB.1014.XX.75	Split Aged Brass and English Metallic Bronze		English Metallic Bronze	Aged Brass
KNB.1014.XX.77	Split Polished Nickel and Satin Brass		Satin Brass	Polished Nickel

Odel Knob Without Back Plate Split Finish

KNB.1014.XX.XX

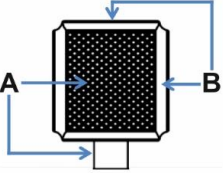
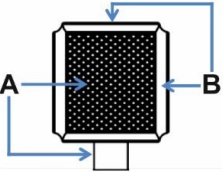
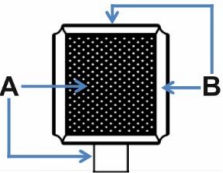
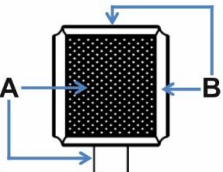
FINISH CODE (XX)	FINISH NAME	LINE DRAWING	A	B
KNB.1014.XX.78	Split Brush Nickel and Satin Brass		Brush Nickel	Satin Brass
KNB.1014.XX.80	Split Oil Rubbed Bronze and Satin Brass		Oil Rubbed Bronze	Satin Brass
KNB.1014.XX.90	Split Graphite and Satin Brass		Graphite	Satin Brass
KNB.1014.XX.91	Split Graphite and Brush Chrome		Graphite	Brush Chrome

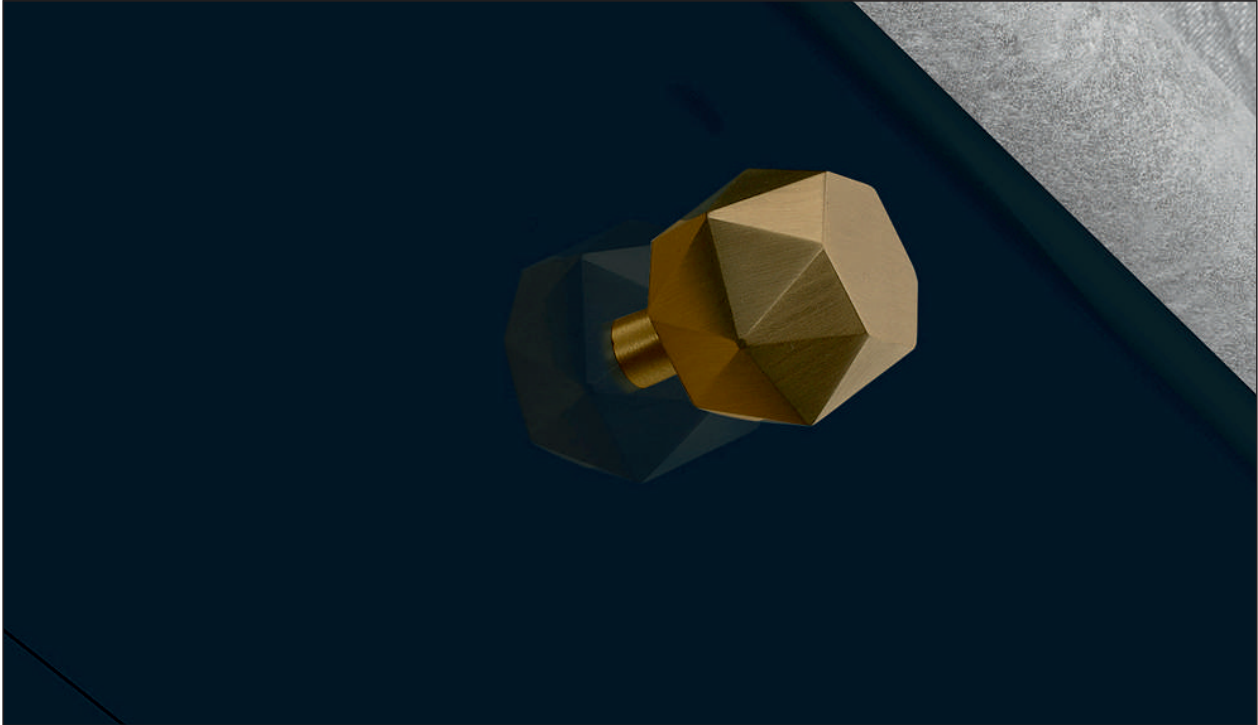

Satin Brass (Finish ID:13)

ALBEMARLE KNOB WITHOUT BACK PLATE

“The hexagonal shape of the knob allied to the precise faceted back plate give the suggestion of a rose opening in the summer sun. Polished nickel reflects light like a prism while aged brass absorbs light accentuating the faceted detail.”

	Item Code	Size (mm & Inches)	Material	Size (Inches)				Fig.
				A	B	C	D	
1	KNB.1025.32.XX	32mm (1.26")	Brass	1.5	1.26	N/A	N/A	1
2	KNB.1025.38.XX	38mm (1.5")	Brass	1.74	1.5	N/A	N/A	1

"XX" in item code denotes Finish ID.

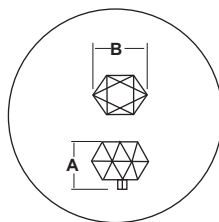

FIG. 1

This product is Supplied with M4x25mm screws.
This product is Supplied with M4x45mm break off screws.

How to Order

KNB.1025.32.13

KNOB STYLE : ALBEMARLE WITHOUT BACK PLATE SIZE DIAMETER : 32 MM FINISH ID : 13

Albemarle Knob Without Back Plate Finish Options

Base Material : Brass		Standard Finishes (2-3 Weeks Delivery)				
						
Bright Chrome (Finish ID:2)	Brush Nickel (Finish ID:3)	Aged Brass (Finish ID:4)	Oil Rubbed Bronze (Finish ID:5)	Unlacquered Polished Brass (Finish ID:7U)	Polished Nickel (Finish ID:8)	Satin Brass (Finish ID:13)
Base Material : Brass		Custom Finishes (3-4 Weeks Delivery)*				
						
Lacquered Polished Brass (Finish ID:7L)	Antique Copper (Finish ID:15)	Matte Black (Finish ID:19)	Rose Gold (Finish ID:33)	English Metallic Bronze (Finish ID:51)	Graphite (Finish ID:61)	Titanium (Finish ID:79)
						
Ombre (Finish ID:92)	Brush Chrome (Finish ID:95)					

- Custom finishes cannot be returned or refunded. We are unable to accept cancellations for custom finish order unless within 48 hours of the order being placed.
- We have uniform pricing for all non-hammered finishes listed above as long as base material and size is same.
- Contact us for customized finishes, refer pages F1, F2, F3 & F4 for finish glossary.
- Backplate options refer page KBP1-1 to KBP14-1.